

omporro 

officine meccaniche porro

PRODUCT **BOOK**

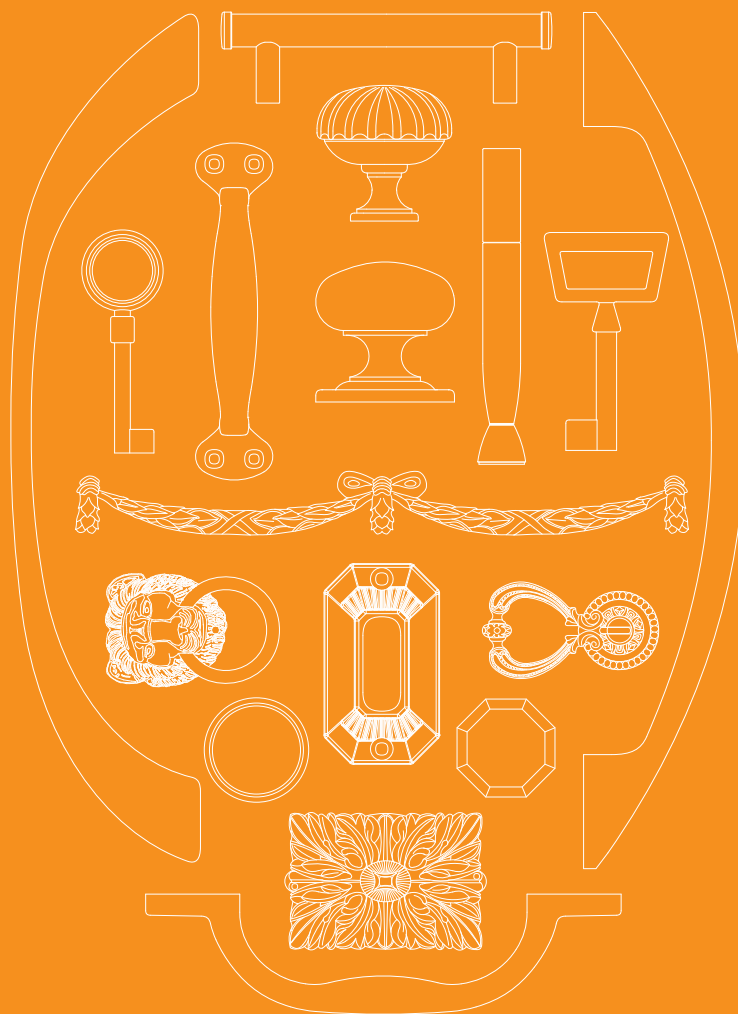

ALFREDO
PORRO



MANUFACTURED BY OFFICINE MECCANICHE PORRO

COMPLEMENTI D'ARREDO IN METALLO NOBILE

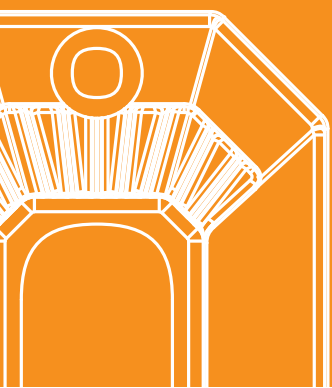
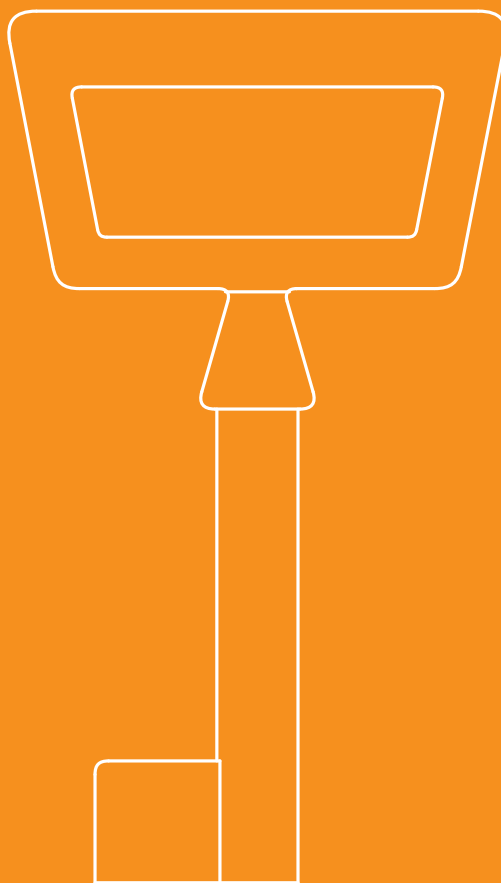



COMPLEMENTI D'ARREDO IN METALLO NOBILE

Il marchio - dedicato al nostro fondatore - contraddistingue la nostra produzione di complementi per mobili, tende e scale in cui la qualità delle materie prime, la funzionalità e l'aspetto decorativo raggiungono livelli estremamente elevati.

Oggetti curati nel dettaglio, solidi e destinati a durare nel tempo e un gran numero di referenze, di stili, di materiali e di finiture che possono soddisfare ogni esigenza e completare, coerentemente, la nostra offerta di maniglie.

Tutti i complementi per mobili, tende e scale della linea Alfredo Porro, come tutta la produzione Officine Meccaniche Porro, sono garantiti come 100% Made in Italy.

NOBLE METAL ACCESSORIES

Our brand, dedicated to our founder, defines our production of accessories for furniture, curtains and stairs whose raw material quality, functionality and decorative aspect reach extremely high levels.

Solid, durable and carefully detailed items, as well as a large number of references, styles, materials and finishes that can meet any expectation and complete our range of handles.

Like the entire Officine Meccaniche Porro catalog, all Alfredo Porro accessories for furniture, curtains and stairs are 100% Made in Italy.

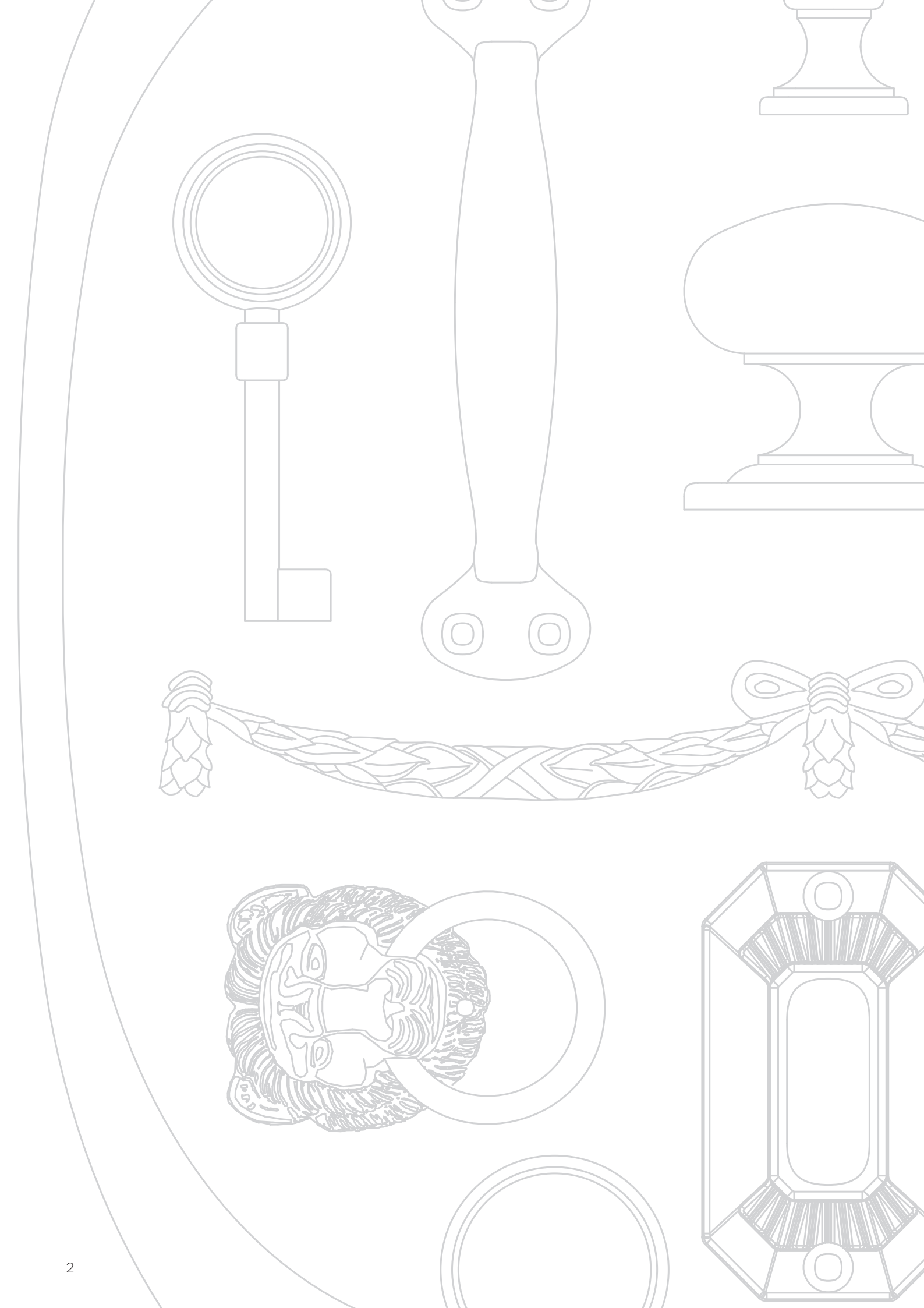

Note tecniche/Technical notes pag 4

Finiture/Finishes pag 6

Ottone/Brass pag 9

Acciaio Inox/Stainless Steel pag 173

Alluminio/Aluminium pag 183

Sistemi di Fissaggio/Fixing Systems pag 198

Fresature Incasso/Milling Cuts pag 201



NOTE TECNICHE TECHNICAL NOTES

Le misure sono espresse in millimetri. Le misure degli articoli indicate nel listino possono subire lievi modifiche di perfezionamento.

All dimensions are in millimeters. Item's dimensions indicated in the price list could vary slightly according to the finished products' requirements.

Tutti i prezzi esposti sono riferiti a singolo pezzo tranne quelli con la dicitura "1 Set".

All the prices displayed refer to one single piece except the ones that are marked by the words "1 Set".

Gli articoli per "mobile" saranno forniti senza le viti di fissaggio.

Articles for "furniture" will be provided without the mounting screws.

Sezione riferimento Catalogo
Catalogue's Reference

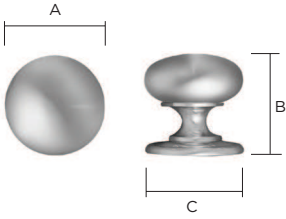
ALFREDO PORRO 	Articolo Item	Misure Sizes				Finitura Finish
		A	B	C	D	
	Pomoli per mobile Cabinet knobs					Oro Lucido Bright Brass <hr/> Bronzo Antico Antique Bronze <hr/> Ottone Antico Ancient Brass <hr/> Nickel Lucido Nickel Plated <hr/> Nickel Satinato Satin Nickel <hr/> Cromo Lucido Chrome Plated <hr/> Cromo Satinato Satin Chrome
		158	35	35	33	

Quota nominale
Nominal size

Codice Articolo
Item Code

Prezzo singolo pezzo
Single piece price

AI	Acciaio Inox	Stainless Steel
AL	Alluminio	Aluminium
V	Vetro	Glass
GI	Giunzione	Connection
R	Rigato	Fluted
A	Aperto	Open
D	Doppio	Double
CG	Con Gancio	With Hook
FS	Fissa	Fixed
BA	Bordi Arrotondati	Round Corners
CM	Cimasa	Cymatium
PI	Piedino	Foot

FINITURE A LISTINO PRICE LIST FINISHING



Oro Lucido

Polished Brass



Bronzo Antico

Antique Bronze



Bronzo Antico
Etrusco

Etruscan Antique
Bronze



Ottone Antico

Ancient Brass



Oro Antico

Old Gold



Nickel Lucido

Nickel Plated



Nickel Satinato

Satin Nickel



Cromo Lucido

Chrome Plated



Cromo Satinato

Satin Chrome

ACCIAIO INOX STAINLESS STEEL



Acciao Lucido

Bright
Stainless Steel



Acciao Satinato

Satin
Stainless Steel

ALLUMINIO ALUMINIUM



Alluminio Cromato

Chrome
Aluminium



Alluminio Anodizzato

Anodised
Aluminium



Alluminio Anodizzato
Inox

Inox Anodised
Aluminium



Oro Non Verniciato
Polished Brass Not Lacquered



Oro PVD
Polished Brass PVD



Bagno Oro
Gold Plated



Bagno Oro PVD
Gold PVD



Oro Antico PVD
Old Gold PVD



Oro Imperiale
Imperial Gold



Oro Satinato
Satin Brass



Argento Vecchio
Antique Silver



Patined Steel



Oil Rubbed Bronze



Bagno Argento
Silver Plated



Matt Black/Matt White

Le finiture non quotate sul listino sono acquistabili per quantità minima equivalente alla confezione ed il relativo prezzo sarà comunicato su richiesta.

Finishes not listed in the price list may be purchased for a minimum quantity equivalent to the pack and the relevant price will be communicated upon request.

I COLORI DELLE FINITURE SONO INDICATIVI

Alcune finiture vengono eseguite manualmente e pertanto possono presentare variazioni di tonalità e sfumatura creando doti di unicità e bellezza del prodotto.

THE COLOURS OF THE FINISHES ARE INDICATIVE

Some of the finishes are performed manually therefore variations in colour tone and shading may occur giving beauty and uniqueness to the product.

..... OTTONE
..... BRASS

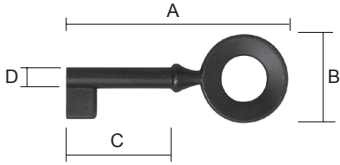
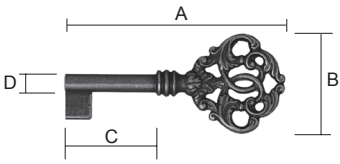
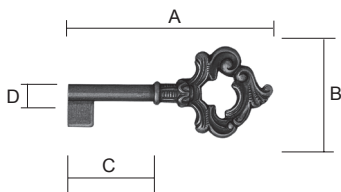
Articolo Item	Misure Sizes				Finitura Finish	
	A	B	C	D		
Chiavi per mobile Cabinet keys					Oro Lucido Polished Brass	
	30	66	26	30	6	Bronzo Antico Antique Bronze
						Nickel Lucido Nickel Plated
 15	40	76	26	40	6	Oro Lucido Polished Brass
						Bronzo Antico Antique Bronze
	45	81	26	45	6	Oro Lucido Polished Brass
						Bronzo Antico Antique Bronze
						Nickel Lucido Nickel Plated
Chiavi per mobile Cabinet keys						Oro Lucido Polished Brass
	30	74	33	30	6	Bronzo Antico Etrusco Etruscan Antique Bronze
 16	40	84	33	40	6	Oro Lucido Polished Brass
						Bronzo Antico Etrusco Etruscan Antique Bronze
Chiavi per mobile Cabinet keys						Oro Lucido Polished Brass
	30	72	31	30	6	Bronzo Antico Etrusco Etruscan Antique Bronze
 17	38	80	31	38	6	Oro Lucido Polished Brass
						Bronzo Antico Etrusco Etruscan Antique Bronze

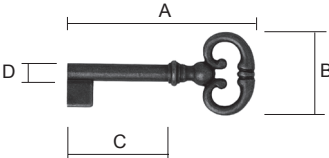
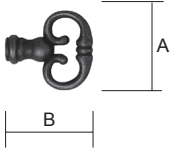
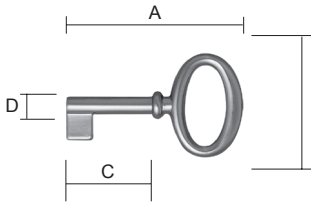
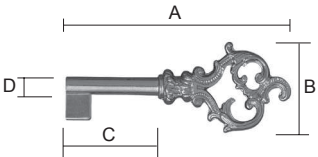
	Articolo Item	Misure Sizes				Finitura Finish		
		A	B	C	D			
	Chiavi per mobile Cabinet keys	30	60	28	30	6	Oro Lucido Polished Brass	
							Bronzo Antico Etrusco Etruscan Antique Bronze	
			35	65	28	35	6	Oro Lucido Polished Brass
								Bronzo Antico Etrusco Etruscan Antique Bronze
			40	70	28	40	6	Oro Lucido Polished Brass
								Bronzo Antico Etrusco Etruscan Antique Bronze
			45	75	28	45	6	Oro Lucido Polished Brass
								Bronzo Antico Etrusco Etruscan Antique Bronze
	Chiavi per mobile Cabinet keys		30		28		Oro Lucido Polished Brass	
							Bronzo Antico Etrusco Etruscan Antique Bronze	
	Chiavi per mobile Cabinet keys	30	61	35	30	6	Oro Lucido Polished Brass	
							Bronzo Antico Antique Bronze	
			40	71	35	40	6	Oro Lucido Polished Brass
								Bronzo Antico Antique Bronze
	Chiavi per mobile Cabinet keys	33	79	32	33	6	Oro Lucido Polished Brass	
							Bronzo Antico Etrusco Etruscan Antique Bronze	
			42	88	32	42	6	Oro Lucido Polished Brass
								Bronzo Antico Etrusco Etruscan Antique Bronze

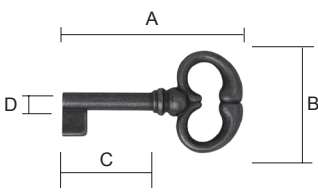
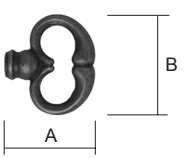
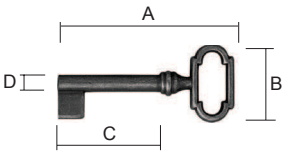
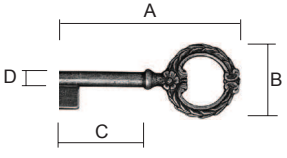
	Articolo Item	Misure Sizes				Finitura Finish	
		A	B	C	D		
	Chiavi per mobile Cabinet keys 30	33	62	35	33	6	Oro Lucido Polished Brass
							Bronzo Antico Etrusco Etruscan Antique Bronze
		42	73	35	41	6	Oro Lucido Polished Brass
							Bronzo Antico Etrusco Etruscan Antique Bronze
	Chiavi per mobile Cabinet keys 30T	31	35			Oro Lucido Polished Brass	
						Bronzo Antico Etrusco Etruscan Antique Bronze	
	Chiavi per mobile Cabinet keys 33	30	56	27	30	6	Oro Lucido Polished Brass
							Bronzo Antico Etrusco Etruscan Antique Bronze
		35	61	27	35	6	Oro Lucido Polished Brass
							Bronzo Antico Etrusco Etruscan Antique Bronze
		40	66	27	40	6	Oro Lucido Polished Brass
							Bronzo Antico Etrusco Etruscan Antique Bronze
		45	71	27	45	6	Oro Lucido Polished Brass
							Bronzo Antico Etrusco Etruscan Antique Bronze
	Chiavi per mobile Cabinet keys 41	35	73	30	35	6	Oro Lucido Polished Brass
							Bronzo Antico Etrusco Etruscan Antique Bronze
		45	82	30	45	6	Oro Lucido Polished Brass
							Bronzo Antico Etrusco Etruscan Antique Bronze

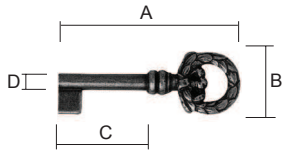
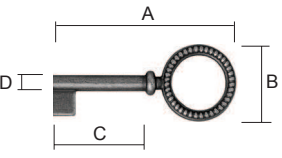
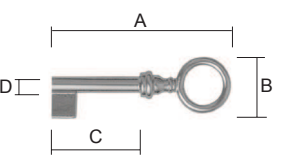
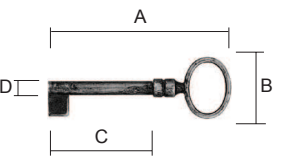
	Articolo Item	Misure Sizes				Finitura Finish		
		A	B	C	D			
	Chiavi per mobile Cabinet keys 44	33	67	23	33	6	Oro Lucido Polished Brass	
								Bronzo Antico Etrusco Etruscan Antique Bronze
		45	79	23	45	6	Oro Lucido Polished Brass	
								Bronzo Antico Etrusco Etruscan Antique Bronze
	Chiavi per mobile Cabinet keys 45	35	68	28	35	6	Oro Lucido Polished Brass	
								Bronzo Antico Etrusco Etruscan Antique Bronze
		42	75	28	42	6	Oro Lucido Polished Brass	
								Bronzo Antico Etrusco Etruscan Antique Bronze
	Chiavi per mobile Cabinet keys 48	32	64	20	32	6	Oro Lucido Polished Brass	
								Bronzo Antico Etrusco Etruscan Antique Bronze
		42	74	20	42	6	Oro Lucido Polished Brass	
								Bronzo Antico Etrusco Etruscan Antique Bronze
	Chiavi per mobile Cabinet keys 55	35	68	26	35	6	Oro Lucido Polished Brass	
								Bronzo Antico Etrusco Etruscan Antique Bronze
		45	78	26	45	6	Oro Lucido Polished Brass	
								Bronzo Antico Etrusco Etruscan Antique Bronze

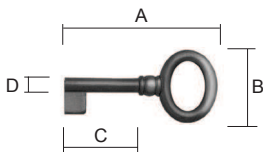
Articolo Item	Misure Sizes				Finitura Finish	
	A	B	C	D		
<p>Chiavi per mobile Cabinet keys</p>  <p>74</p>	30	62	30	30	6	Oro Lucido Polished Brass
						Bronzo Antico Antique Bronze
						Bronzo Antico Etrusco Etruscan Antique Bronze
						Cromo Lucido Chrome Plated
	40	72	30	40	6	Oro Lucido Polished Brass
						Bronzo Antico Antique Bronze
						Bronzo Antico Etrusco Etruscan Antique Bronze
						Cromo Lucido Chrome Plated
						Cromo Satinato Satin Chrome

QUANTITATIVO MINIMO D'ORDINE:
1000 PEZZI, SUDDIVISI IN
TRE FINITURE DIFFERENTI

MINIMUM ORDER QUANTITY:
1000 PIECES EACH REFERENCE, SUBDIVIDED INTO
MAXIMUM THREE DIFFERENT FINISHES

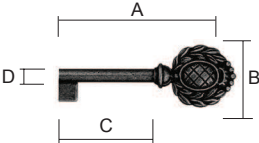
	<p>Chiavi per mobile Archivio Alfredo Porro Cabinet keys from Alfredo Porro Archive</p> <p>1</p>	35	74	29	35	6	Oro Lucido Polished Brass	
								Bronzo Antico Antique Bronze
		45	84	29	45	6	Oro Lucido Polished Brass	
								Bronzo Antico Antique Bronze

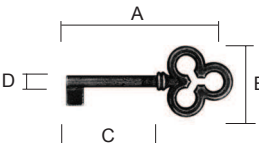
	<p>Chiavi per mobile Archivio Alfredo Porro Cabinet keys from Alfredo Porro Archive</p> <p>2</p>	35	73	35	35	6	Oro Lucido Polished Brass	
								Bronzo Antico Antique Bronze
		45	83	35	45	6	Oro Lucido Polished Brass	
								Bronzo Antico Antique Bronze

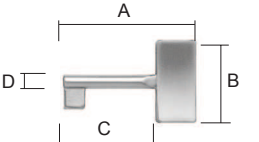
	<p>Chiavi per mobile Archivio Alfredo Porro Cabinet keys from Alfredo Porro Archive</p> <p>9</p>	30	47	35	30	6	Oro Lucido Polished Brass	
								Bronzo Antico Antique Bronze
		40	57	35	40	6	Oro Lucido Polished Brass	
								Bronzo Antico Antique Bronze
		50	67	35	50	6	Oro Lucido Polished Brass	
								Bronzo Antico Antique Bronze

QUANTITATIVO MINIMO D'ORDINE:
1000 PEZZI, SUDDIVISI IN
TRE FINITURE DIFFERENTI

MINIMUM ORDER QUANTITY:
1000 PIECES EACH REFERENCE, SUBDIVIDED INTO
MAXIMUM THREE DIFFERENT FINISHES

Chiavi per mobile
Archivio Alfredo Porro
Cabinet keys from
Alfredo Porro Archive

23 66 31 23 6

Oro Lucido
Polished Brass

Bronzo Antico
Antique Bronze

10

33 76 31 33 6

Oro Lucido
Polished Brass

Bronzo Antico
Antique Bronze

42 85 31 42 6

Oro Lucido
Polished Brass

Bronzo Antico
Antique Bronze

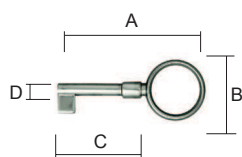

Chiavi per mobile
Archivio Alfredo Porro
Cabinet keys from
Alfredo Porro Archive

40 56 33 40 6

Oro Lucido
Polished Brass

Bronzo Antico
Antique Bronze

11

50 68 33 50 6

Oro Lucido
Polished Brass

Bronzo Antico
Antique Bronze

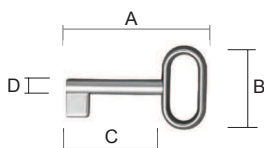

Chiavi per mobile
Archivio Alfredo Porro
Cabinet keys from
Alfredo Porro Archive

23 54 39 23 6

Oro Lucido
Polished Brass

Bronzo Antico
Antique Bronze

12

32 63 39 32 6

Oro Lucido
Polished Brass

Bronzo Antico
Antique Bronze

42 73 39 42 6

Oro Lucido
Polished Brass

Bronzo Antico
Antique Bronze

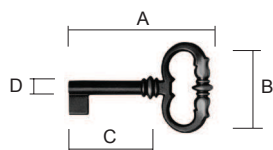

Articolo
Item

Misure
Sizes

Finitura
Finish

A

B

C

D

Chiavi per mobile
Archivio Alfredo Porro
Cabinet keys from
Alfredo Porro Archive

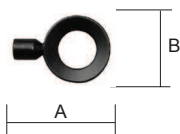

15 T

36 26

Oro Lucido
Polished Brass

Bronzo Antico
Antique Bronze

Chiavi per mobile
Archivio Alfredo Porro
Cabinet keys from
Alfredo Porro Archive

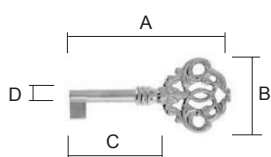

16 M

30 74 33 30 5

Oro Lucido
Polished Brass

Bronzo Antico
Antique Bronze

Chiavi per mobile
Archivio Alfredo Porro
Cabinet keys from
Alfredo Porro Archive

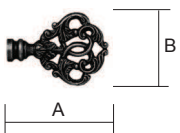

16 T

44 33

Oro Lucido
Polished Brass

Bronzo Antico
Antique Bronze

Chiavi per mobile
Archivio Alfredo Porro
Cabinet keys from
Alfredo Porro Archive

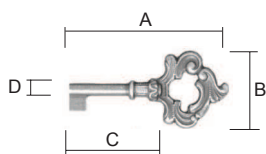

17 M

25 67 31 25 5

Oro Lucido
Polished Brass

Bronzo Antico
Antique Bronze

35 77 31 35 5

Oro Lucido
Polished Brass

Bronzo Antico
Antique Bronze

QUANTITATIVO MINIMO D'ORDINE:
1000 PEZZI, SUDDIVISI IN
TRE FINITURE DIFFERENTI

MINIMUM ORDER QUANTITY:
1000 PIECES EACH REFERENCE, SUBDIVIDED INTO
MAXIMUM THREE DIFFERENT FINISHES

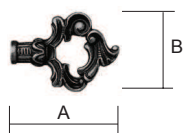

Chiavi per mobile
Archivio Alfredo Porro
Cabinet keys from
Alfredo Porro Archive

17T

41 31

Oro Lucido
Polished Brass

Bronzo Antico
Antique Bronze

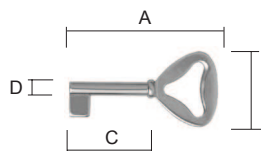

Chiavi per mobile
Archivio Alfredo Porro
Cabinet keys from
Alfredo Porro Archive

22

33 63 32 33 6

Oro Lucido
Polished Brass

Bronzo Antico
Antique Bronze

45 73 32 45 6

Oro Lucido
Polished Brass

Bronzo Antico
Antique Bronze

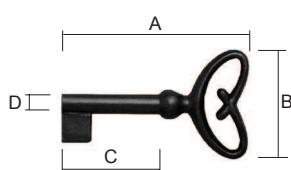

Chiavi per mobile
Archivio Alfredo Porro
Cabinet keys from
Alfredo Porro Archive

24

30 59 34 30 6

Oro Lucido
Polished Brass

Bronzo Antico
Antique Bronze

40 69 34 40 6

Oro Lucido
Polished Brass

Bronzo Antico
Antique Bronze

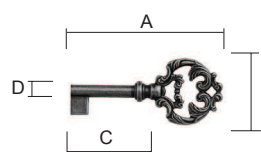

Chiavi per mobile
Archivio Alfredo Porro
Cabinet keys from
Alfredo Porro Archive

25

32 75 33 32 6

Oro Lucido
Polished Brass

Bronzo Antico
Antique Bronze

42 85 33 42 6

Oro Lucido
Polished Brass

Bronzo Antico
Antique Bronze

Articolo
Item

Misure
Sizes

Finitura
Finish

A B C D

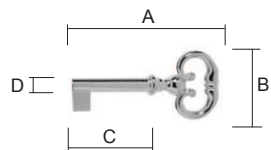

Chiavi per mobile
Archivio Alfredo Porro
Cabinet keys from
Alfredo Porro Archive

26 M

30 60 28 30 5

Oro Lucido
Polished Brass

Bronzo Antico
Antique Bronze

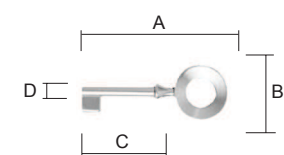

Chiavi per mobile
Archivio Alfredo Porro
Cabinet keys from
Alfredo Porro Archive

27 M

34 70 26 34 5

Oro Lucido
Polished Brass

Bronzo Antico
Antique Bronze

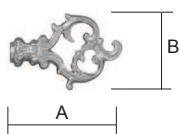

Chiavi per mobile
Archivio Alfredo Porro
Cabinet keys from
Alfredo Porro Archive

29 T

47 32

Oro Lucido
Polished Brass

Bronzo Antico
Antique Bronze

Chiavi per mobile
Archivio Alfredo Porro
Cabinet keys from
Alfredo Porro Archive

27 50 28 27 6

Oro Lucido
Polished Brass

Bronzo Antico
Antique Bronze

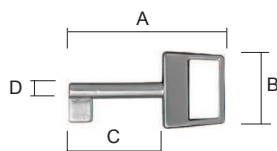

32

35 58 28 35 6

Oro Lucido
Polished Brass

Bronzo Antico
Antique Bronze

42 65 28 42 6

Oro Lucido
Polished Brass

Bronzo Antico
Antique Bronze

QUANTITATIVO MINIMO D'ORDINE:
1000 PEZZI, SUDDIVISI IN
TRE FINITURE DIFFERENTI

MINIMUM ORDER QUANTITY:
1000 PIECES EACH REFERENCE, SUBDIVIDED INTO
MAXIMUM THREE DIFFERENT FINISHES

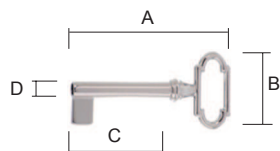

Chiavi per mobile
Archivio Alfredo Porro
Cabinet keys from
Alfredo Porro Archive

34 M

27

50

27

27

5

Oro Lucido
Polished Brass

Bronzo Antico
Antique Bronze

37

60

27

37

5

Oro Lucido
Polished Brass

Bronzo Antico
Antique Bronze

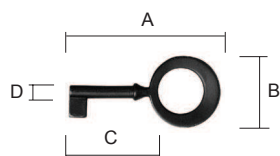

Chiavi per mobile
Archivio Alfredo Porro
Cabinet keys from
Alfredo Porro Archive

35

30

71

33

30

6

Oro Lucido
Polished Brass

Bronzo Antico
Antique Bronze

40

81

33

40

6

Oro Lucido
Polished Brass

Bronzo Antico
Antique Bronze

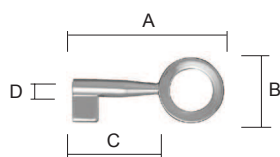

Chiavi per mobile
Archivio Alfredo Porro
Cabinet keys from
Alfredo Porro Archive

37

25

53

23

25

6

Oro Lucido
Polished Brass

Bronzo Antico
Antique Bronze

30

53

23

30

6

Oro Lucido
Polished Brass

Bronzo Antico
Antique Bronze

Articolo
Item

Misure
Sizes

Finitura
Finish

A B C D

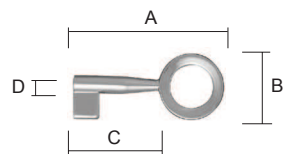

Chiavi per mobile
Archivio Alfredo Porro
Cabinet keys from
Alfredo Porro Archive

37

35 58 23 35 6

Oro Lucido
Polished Brass

Bronzo Antico
Antique Bronze

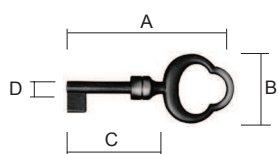

Chiavi per mobile
Archivio Alfredo Porro
Cabinet keys from
Alfredo Porro Archive

38

30 79 33 30 6

Oro Lucido
Polished Brass

Bronzo Antico
Antique Bronze

40 89 33 40 6

Oro Lucido
Polished Brass

Bronzo Antico
Antique Bronze

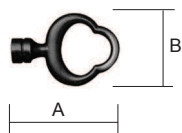

Chiavi per mobile
Archivio Alfredo Porro
Cabinet keys from
Alfredo Porro Archive

38T

49 33

Oro Lucido
Polished Brass

Bronzo Antico
Antique Bronze

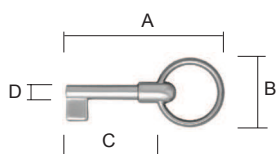

Chiavi per mobile
Archivio Alfredo Porro
Cabinet keys from
Alfredo Porro Archive

39

30 66 28 30 6

Oro Lucido
Polished Brass

Bronzo Antico
Antique Bronze

35 71 28 35 6

Oro Lucido
Polished Brass

Bronzo Antico
Antique Bronze

40 76 28 40 6

Oro Lucido
Polished Brass

Bronzo Antico
Antique Bronze

QUANTITATIVO MINIMO D'ORDINE:
1000 PEZZI, SUDDIVISI IN
TRE FINITURE DIFFERENTI

MINIMUM ORDER QUANTITY:
1000 PIECES EACH REFERENCE, SUBDIVIDED INTO
MAXIMUM THREE DIFFERENT FINISHES

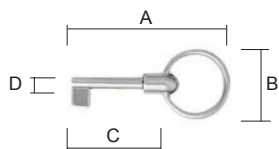

Chiavi per mobile
Archivio Alfredo Porro
Cabinet keys from
Alfredo Porro Archive

40 M

30 66 28 30 5

Oro Lucido
Polished Brass

Bronzo Antico
Antique Bronze

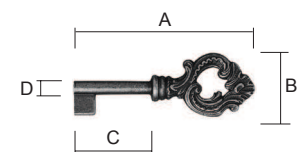

Chiavi per mobile
Archivio Alfredo Porro
Cabinet keys from
Alfredo Porro Archive

43

33 78 27 33 6

Oro Lucido
Polished Brass

Bronzo Antico Etrusco
Etruscan Antique Bronze

42 87 27 42 6

Oro Lucido
Polished Brass

Bronzo Antico Etrusco
Etruscan Antique Bronze



Chiavi per mobile
Archivio Alfredo Porro
Cabinet keys from
Alfredo Porro Archive

43 T

45 28

Oro Lucido
Polished Brass

Bronzo Antico Etrusco
Etruscan Antique Bronze



Chiavi per mobile
Archivio Alfredo Porro
Cabinet keys from
Alfredo Porro Archive

44 T

33 23

Oro Lucido
Polished Brass

Bronzo Antico
Antique Bronze

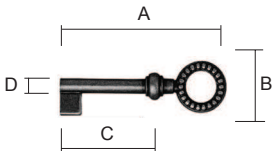
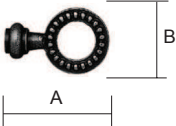
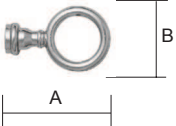
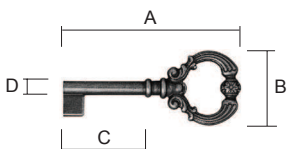
	Articolo Item	Misure Sizes				Finitura Finish		
		A	B	C	D			
	Chiavi per mobile Archivio Alfredo Porro Cabinet keys from Alfredo Porro Archive	25	58	21	25	6	Oro Lucido Polished Brass	
							Bronzo Antico Antique Bronze	
	47	35	68	21	35	6	Oro Lucido Polished Brass	
							Bronzo Antico Antique Bronze	
			42	75	21	42	6	Oro Lucido Polished Brass
								Bronzo Antico Antique Bronze
	Chiavi per mobile Archivio Alfredo Porro Cabinet keys from Alfredo Porro Archive			33	21		Oro Lucido Polished Brass	
							Bronzo Antico Antique Bronze	
47 T								
	Chiavi per mobile Archivio Alfredo Porro Cabinet keys from Alfredo Porro Archive			32	20		Oro Lucido Polished Brass	
							Bronzo Antico Antique Bronze	
48 T								
	Chiavi per mobile Archivio Alfredo Porro Cabinet keys from Alfredo Porro Archive	35	76	32	35	6	Oro Lucido Polished Brass	
							Bronzo Antico Etrusco Etruscan Antique Bronze	
	49	45	82	32	45	6	Oro Lucido Polished Brass	
							Bronzo Antico Etrusco Etruscan Antique Bronze	

QUANTITATIVO MINIMO D'ORDINE:
1000 PEZZI, SUDDIVISI IN
TRE FINITURE DIFFERENTI

MINIMUM ORDER QUANTITY:
1000 PIECES EACH REFERENCE, SUBDIVIDED INTO
MAXIMUM THREE DIFFERENT FINISHES

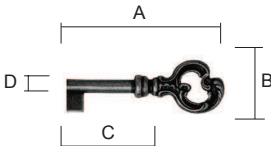
	Articolo Item	Misure Sizes				Finitura Finish	
		A	B	C	D		
	Chiavi per mobile Archivio Alfredo Porro Cabinet keys from Alfredo Porro Archive	23	63	28	23	6	Oro Lucido Polished Brass
							Bronzo Antico Antique Bronze
	52	33	74	28	33	6	Oro Lucido Polished Brass
							Bronzo Antico Antique Bronze
		42	83	28	42	6	Oro Lucido Polished Brass
							Bronzo Antico Antique Bronze

	Chiavi per mobile Archivio Alfredo Porro Cabinet keys from Alfredo Porro Archive			41	28		Oro Lucido Polished Brass
	52 T						Bronzo Antico Antique Bronze

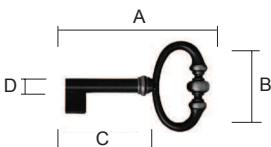
	Chiavi per mobile Archivio Alfredo Porro Cabinet keys from Alfredo Porro Archive	35	69	39	35	6	Oro Lucido Polished Brass
	53						Bronzo Antico Etrusco Etruscan Antique Bronze

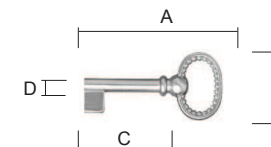
	Chiavi per mobile Archivio Alfredo Porro Cabinet keys from Alfredo Porro Archive	23	50	29	23	6	Oro Lucido Polished Brass
							Bronzo Antico Antique Bronze
	54	32	59	29	32	6	Oro Lucido Polished Brass
							Bronzo Antico Antique Bronze
		42	69	29	42	6	Oro Lucido Polished Brass
							Bronzo Antico Antique Bronze

Articolo
Item

Misure
Sizes

Finitura
Finish

A

B

C

D

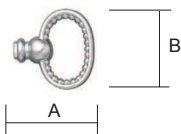

Chiavi per mobile
Archivio Alfredo Porro
Cabinet keys from
Alfredo Porro Archive

54 T

27

29

Oro Lucido
Polished Brass

Bronzo Antico
Antique Bronze

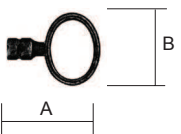

Chiavi per mobile
Archivio Alfredo Porro
Cabinet keys from
Alfredo Porro Archive

55 T

33

26

Oro Lucido
Polished Brass

Bronzo Antico
Antique Bronze

Chiavi per mobile
Archivio Alfredo Porro
Cabinet keys from
Alfredo Porro Archive

56

25

49

24

25

6

Oro Lucido
Polished Brass

Bronzo Antico
Antique Bronze

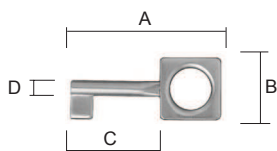

35

59

24

35

6

Oro Lucido
Polished Brass

Bronzo Antico
Antique Bronze

45

69

24

45

6

Oro Lucido
Polished Brass

Bronzo Antico
Antique Bronze

Chiavi per mobile
Archivio Alfredo Porro
Cabinet keys from
Alfredo Porro Archive

57

25

61

25

25

6

Oro Lucido
Polished Brass

Bronzo Antico
Antique Bronze

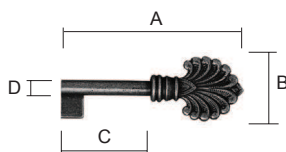

35

71

25

35

6

Oro Lucido
Polished Brass

Bronzo Antico
Antique Bronze

45

81

25

45

6

Oro Lucido
Polished Brass

Bronzo Antico
Antique Bronze

QUANTITATIVO MINIMO D'ORDINE:
1000 PEZZI, SUDDIVISI IN
TRE FINITURE DIFFERENTI

MINIMUM ORDER QUANTITY:
1000 PIECES EACH REFERENCE, SUBDIVIDED INTO
MAXIMUM THREE DIFFERENT FINISHES



Chiavi per mobile
Archivio Alfredo Porro
Cabinet keys from
Alfredo Porro Archive

57 T

36 25

Oro Lucido
Polished Brass

Bronzo Antico
Antique Bronze

Chiavi per mobile
Archivio Alfredo Porro
Cabinet keys from
Alfredo Porro Archive

25

54

36

25

6

Oro Lucido
Polished Brass

Bronzo Antico
Antique Bronze

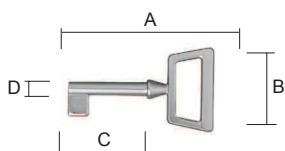

59

35

64

36

35

6

Oro Lucido
Polished Brass

Bronzo Antico
Antique Bronze

42

71

36

42

6

Oro Lucido
Polished Brass

Bronzo Antico
Antique Bronze

Chiavi per mobile
Archivio Alfredo Porro
Cabinet keys from
Alfredo Porro Archive

25

54

36

25

6

Oro Lucido
Polished Brass

Bronzo Antico
Antique Bronze

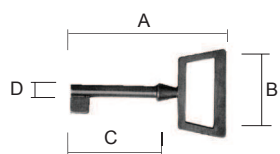

59 M

35

64

36

35

6

Oro Lucido
Polished Brass

Bronzo Antico
Antique Bronze

Chiavi per mobile
Archivio Alfredo Porro
Cabinet keys from
Alfredo Porro Archive

25

49

36

25

6

Oro Lucido
Polished Brass

Bronzo Antico
Antique Bronze

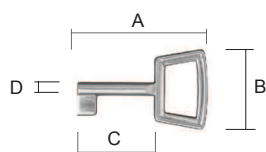

60

35

59

36

35

6

Oro Lucido
Polished Brass

Bronzo Antico
Antique Bronze

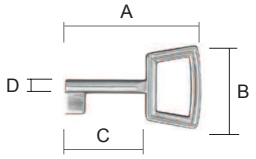
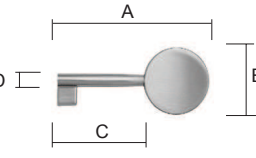
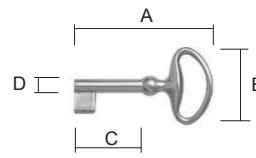
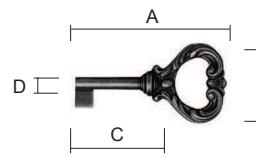
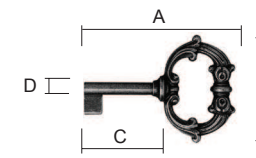
	Articolo Item	Misure Sizes				Finitura Finish		
		A	B	C	D			
	Chiavi per mobile Archivio Alfredo Porro Cabinet keys from Alfredo Porro Archive 60 M	25	46	36	25	5	Oro Lucido Polished Brass	
								Bronzo Antico Antique Bronze
		35	56	36	35	5	Oro Lucido Polished Brass	
								Bronzo Antico Antique Bronze
	Chiavi per mobile Archivio Alfredo Porro Cabinet keys from Alfredo Porro Archive 67	30	60	30	30	6	Oro Lucido Polished Brass	
								Bronzo Antico Antique Bronze
		40	70	30	40	6	Oro Lucido Polished Brass	
								Bronzo Antico Antique Bronze
	Chiavi per mobile Archivio Alfredo Porro Cabinet keys from Alfredo Porro Archive 68	40	70	34	40	6	Oro Lucido Polished Brass	
								Bronzo Antico Antique Bronze
	Chiavi per mobile Archivio Alfredo Porro Cabinet keys from Alfredo Porro Archive 69	32	73	38	32	6	Oro Lucido Polished Brass	
								Bronzo Antico Antique Bronze
		42	83	38	42	6	Oro Lucido Polished Brass	
								Bronzo Antico Antique Bronze
	Chiavi per mobile Archivio Alfredo Porro Cabinet keys from Alfredo Porro Archive 71	32	70	50	32	6	Oro Lucido Polished Brass	
								Bronzo Antico Antique Bronze
		42	80	50	42	6	Oro Lucido Polished Brass	
								Bronzo Antico Antique Bronze

QUANTITATIVO MINIMO D'ORDINE:
1000 PEZZI, SUDDIVISI IN
TRE FINITURE DIFFERENTI

MINIMUM ORDER QUANTITY:
1000 PIECES EACH REFERENCE, SUBDIVIDED INTO
MAXIMUM THREE DIFFERENT FINISHES

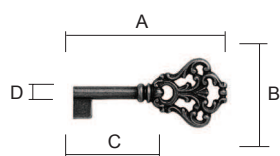

Chiavi per mobile
Archivio Alfredo Porro
Cabinet keys from
Alfredo Porro Archive

73

30 72 32 30 6

Oro Lucido
Polished Brass

Bronzo Antico
Antique Bronze

40 82 32 40 6

Oro Lucido
Polished Brass

Bronzo Antico
Antique Bronze

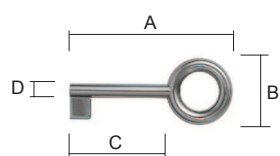

Chiavi per mobile
Archivio Alfredo Porro
Cabinet keys from
Alfredo Porro Archive

75

30 58 28 30 6

Oro Lucido
Polished Brass

Bronzo Antico
Antique Bronze

40 68 28 40 6

Oro Lucido
Polished Brass

Bronzo Antico
Antique Bronze

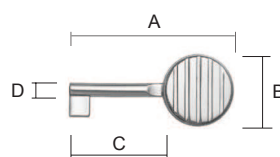

Chiavi per mobile
Archivio Alfredo Porro
Cabinet keys from
Alfredo Porro Archive

76

30 61 31 30 6

Oro Lucido
Polished Brass

Bronzo Antico
Antique Bronze

40 71 31 40 6

Oro Lucido
Polished Brass

Bronzo Antico
Antique Bronze

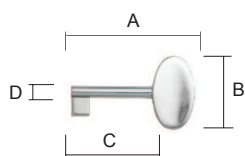

Chiavi per mobile
Archivio Alfredo Porro
Cabinet keys from
Alfredo Porro Archive

78

30 51 36 30 6

Oro Lucido
Polished Brass

Bronzo Antico
Antique Bronze

40 61 36 40 6

Oro Lucido
Polished Brass

Bronzo Antico
Antique Bronze

Articolo
Item

Misure
Sizes

A B C D

Finitura
Finish

Pomoli per mobile
Cabinet knobs

Oro Lucido
Polished Brass

Bronzo Antico
Antique Bronze

Nickel Lucido
Nickel Plated

20 20 18 11

Nickel Satinato
Satin Nickel

Cromo Lucido
Chrome Plated

Cromo Satinato
Satin Chrome

Oro Lucido
Polished Brass

Bronzo Antico
Antique Bronze

Nickel Lucido
Nickel Plated

25 25 22 14

Nickel Satinato
Satin Nickel

Cromo Lucido
Chrome Plated

Cromo Satinato
Satin Chrome

Oro Lucido
Polished Brass

Bronzo Antico
Antique Bronze

Nickel Lucido
Nickel Plated

31 31 28 18

Nickel Satinato
Satin Nickel

Cromo Lucido
Chrome Plated

Cromo Satinato
Satin Chrome

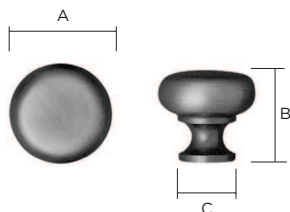

100

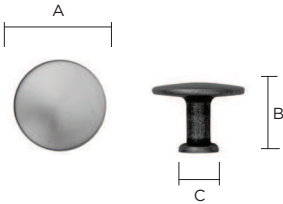
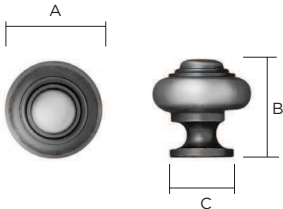
Articolo Item	Misure Sizes				Finitura Finish
	A	B	C	D	
<p>Pomoli per mobile Cabinet knobs</p>  <p>101</p>					Oro Lucido Polished Brass
	20	20	16	10	Ottone Antico Ancient Brass
					Nickel Satinato Satin Nickel
					Cromo Lucido Chrome Plated
					Oro Lucido Polished Brass
	25	25	20	11	Ottone Antico Ancient Brass
					Nickel Satinato Satin Nickel
					Cromo Lucido Chrome Plated
					Oro Lucido Polished Brass
	30	30	23	14	Ottone Antico Ancient Brass
					Nickel Satinato Satin Nickel
					Cromo Lucido Chrome Plated
<p>Pomoli per mobile Cabinet knobs</p>  <p>102</p>	25	25	24	16	Oro Lucido Polished Brass
					Bronzo Antico Antique Bronze
	30	30	28	19	Oro Lucido Polished Brass
					Bronzo Antico Antique Bronze
	40	40	37	25	Oro Lucido Polished Brass
					Bronzo Antico Antique Bronze

Articolo
Item

Misure
Sizes

Finitura
Finish

A

B

C

D

Pomoli per mobile
Cabinet knobs

Oro Lucido
Polished Brass

Bronzo Antico
Antique Bronze

25 25 27 13 15

Nickel Satinato
Satin Nickel

Cromo Lucido
Chrome Plated

Oro Lucido
Polished Brass

Bronzo Antico
Antique Bronze

30 30 32 13 20

Nickel Satinato
Satin Nickel

Cromo Lucido
Chrome Plated

Oro Lucido
Polished Brass

Bronzo Antico
Antique Bronze

35 34 37 15 23

Nickel Satinato
Satin Nickel

Cromo Lucido
Chrome Plated

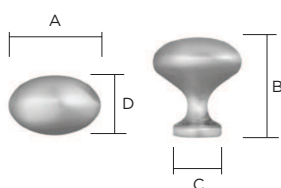

105

Pomoli per mobile
Cabinet knobs

Oro Lucido
Polished Brass

Bronzo Antico Etrusco
Etruscan Antique Bronze

25 25 21 14

Oro Lucido
Polished Brass

Bronzo Antico Etrusco
Etruscan Antique Bronze

30 31 23 16

Oro Lucido
Polished Brass

Bronzo Antico Etrusco
Etruscan Antique Bronze

35 35 29 19

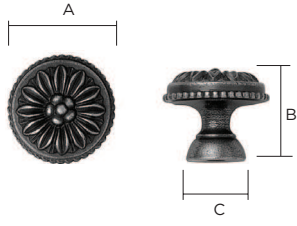

120

Articolo Item	Misure Sizes				Finitura Finish	
	A	B	C	D		
Pomoli per mobile Cabinet knobs					Oro Lucido Polished Brass	
	15	15	16	9	Bronzo Antico Etrusco Etruscan Antique Bronze	
					Oro Antico Old Gold	
					Oro Lucido Polished Brass	
	20	20	18	11	Bronzo Antico Etrusco Etruscan Antique Bronze	
					Oro Antico Old Gold	
	130				Oro Lucido Polished Brass	
		25	25	22	14	Bronzo Antico Etrusco Etruscan Antique Bronze
						Oro Antico Old Gold
					Oro Lucido Polished Brass	
	30	30	26	16	Bronzo Antico Etrusco Etruscan Antique Bronze	
					Oro Antico Old Gold	
					Oro Lucido Polished Brass	
	35	35	30	19	Bronzo Antico Etrusco Etruscan Antique Bronze	
					Oro Antico Old Gold	

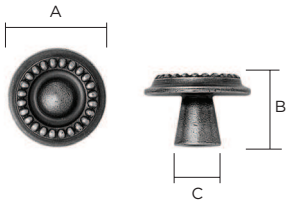
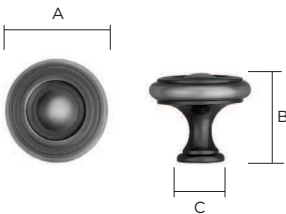
	Articolo Item	Misure Sizes				Finitura Finish	
		A	B	C	D		
	Pomoli per mobile Cabinet knobs	30	30	23	14	Oro Lucido Polished Brass	
	135					Bronzo Antico Antique Bronze	
	Oro Antico Old Gold						
			35	35	27	17	Oro Lucido Polished Brass
		Bronzo Antico Antique Bronze					
		Oro Antico Old Gold					
	Pomoli per mobile Cabinet knobs	25	25	17	11	Oro Lucido Polished Brass	
	140					Bronzo Antico Etrusco Etruscan Antique Bronze	
		30	30	18	12	Oro Lucido Polished Brass	
						Bronzo Antico Etrusco Etruscan Antique Bronze	
		35	34	19	14	Oro Lucido Polished Brass	
	Bronzo Antico Etrusco Etruscan Antique Bronze						
	Pomoli per mobile Cabinet knobs	30	30	26	14	Oro Lucido Polished Brass	
	141					Bronzo Antico Antique Bronze	
						Nickel Lucido Nickel Plated	
		Nickel Satinato Satin Nickel					
		35	35	31	16	Oro Lucido Polished Brass	
	Bronzo Antico Antique Bronze						
	Nickel Lucido Nickel Plated						
	Nickel Satinato Satin Nickel						

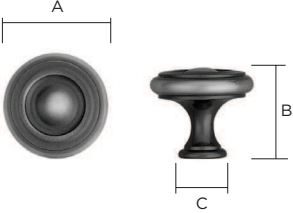
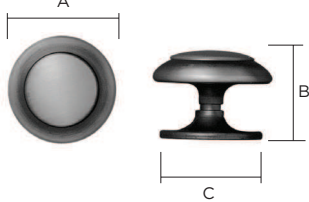
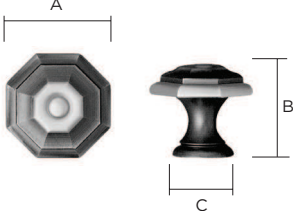

	Articolo Item	Misure Sizes				Finitura Finish
		A	B	C	D	
	Pomoli per mobile Cabinet knobs 141	40	40	35	19	Oro Lucido Polished Brass
						Bronzo Antico Antique Bronze
						Nickel Lucido Nickel Plated
						Nickel Satinato Satin Nickel
	Pomoli per mobile Cabinet knobs 142	25	25	19	21	Oro Lucido Polished Brass
						Bronzo Antico Antique Bronze
						Oro Lucido Polished Brass
						Bronzo Antico Antique Bronze
						Oro Lucido Polished Brass
						Bronzo Antico Antique Bronze
	Pomoli per mobile Cabinet knobs 145	25	25	22	15	Oro Lucido Polished Brass
						Bronzo Antico Antique Bronze
						Oro Lucido Polished Brass
						Bronzo Antico Antique Bronze
						Oro Lucido Polished Brass
						Bronzo Antico Antique Bronze

Articolo
Item

Misure
Sizes

Finitura
Finish

A

B

C

D

Pomoli per mobile
Cabinet knobs

Oro Lucido
Polished Brass

Bronzo Antico
Antique Bronze

Nickel Lucido
Nickel Plated

Nickel Satinato
Satin Nickel

25 25 19 15

Oro Lucido
Polished Brass

Bronzo Antico
Antique Bronze

Nickel Lucido
Nickel Plated

Nickel Satinato
Satin Nickel

30 30 22 17

Oro Lucido
Polished Brass

Bronzo Antico
Antique Bronze

Nickel Lucido
Nickel Plated

Nickel Satinato
Satin Nickel

40 39 27 20

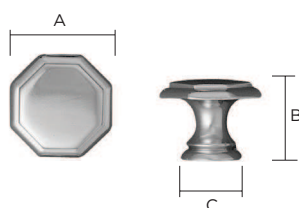

146

Pomoli per mobile
Cabinet knobs

Oro Lucido
Polished Brass

Nickel Satinato
Satin Nickel

Cromo Lucido
Chrome Plated

Cromo Satinato
Satin Chrome

25 25 23 23

Oro Lucido
Polished Brass

Nickel Satinato
Satin Nickel

Cromo Lucido
Chrome Plated

Cromo Satinato
Satin Chrome

30 30 27 27

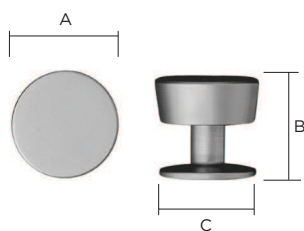

151

Pomoli per mobile
Cabinet knobs

Oro Lucido
Polished Brass

Nickel Satinato
Satin Nickel

12 12 19 12

Cromo Lucido
Chrome Plated

Cromo Satinato
Satin Chrome

Oro Lucido
Polished Brass

Nickel Satinato
Satin Nickel

15 15 22 15

Cromo Lucido
Chrome Plated

Cromo Satinato
Satin Chrome

Oro Lucido
Polished Brass

Nickel Satinato
Satin Nickel

18 18 24 18

Cromo Lucido
Chrome Plated

Cromo Satinato
Satin Chrome

Oro Lucido
Polished Brass

Nickel Satinato
Satin Nickel

21 21 27 21

Cromo Lucido
Chrome Plated

Cromo Satinato
Satin Chrome

Oro Lucido
Polished Brass

Nickel Satinato
Satin Nickel

25 25 32 25

Cromo Lucido
Chrome Plated

Cromo Satinato
Satin Chrome

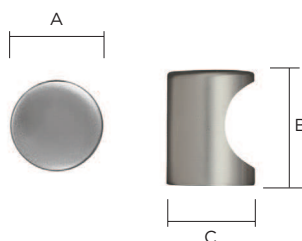

153

Articolo
Item

Misure
Sizes

Finitura
Finish

A

B

C

D

Pomoli per mobile
Cabinet knobs

Oro Lucido
Polished Brass

Bronzo Antico
Antique Bronze

Ottone Antico
Ancient Brass

20 20 20 20

Nickel Lucido
Nickel Plated

Nickel Satinato
Satin Nickel

Cromo Lucido
Chrome Plated

Cromo Satinato
Satin Chrome

Oro Lucido
Polished Brass

Bronzo Antico
Antique Bronze

Ottone Antico
Ancient Brass

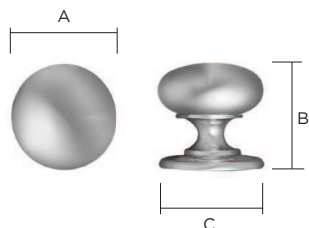

158

25 25 25 25

Nickel Lucido
Nickel Plated

Nickel Satinato
Satin Nickel

Cromo Lucido
Chrome Plated

Cromo Satinato
Satin Chrome

Oro Lucido
Polished Brass

Bronzo Antico
Antique Bronze

Ottone Antico
Ancient Brass

30 30 30 30

Nickel Lucido
Nickel Plated

Nickel Satinato
Satin Nickel

Cromo Lucido
Chrome Plated

Cromo Satinato
Satin Chrome

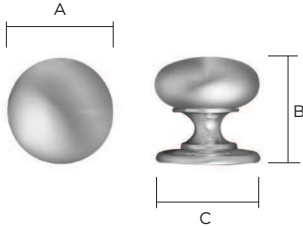
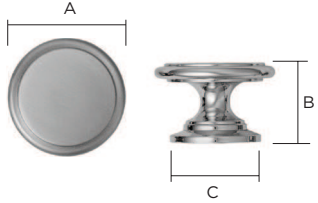

Articolo Item	Misure Sizes				Finitura Finish	
	A	B	C	D		
<p>Pomoli per mobile Cabinet knobs</p>  <p>158</p>	35	35	35	33	<p>Oro Lucido Polished Brass</p> <hr/> <p>Bronzo Antico Antique Bronze</p> <hr/> <p>Ottone Antico Ancient Brass</p> <hr/> <p>Nickel Lucido Nickel Plated</p> <hr/> <p>Nickel Satinato Satin Nickel</p> <hr/> <p>Cromo Lucido Chrome Plated</p> <hr/> <p>Cromo Satinato Satin Chrome</p>	
	40	40	40	33	<p>Oro Lucido Polished Brass</p> <hr/> <p>Bronzo Antico Antique Bronze</p> <hr/> <p>Ottone Antico Ancient Brass</p> <hr/> <p>Nickel Lucido Nickel Plated</p> <hr/> <p>Nickel Satinato Satin Nickel</p> <hr/> <p>Cromo Lucido Chrome Plated</p> <hr/> <p>Cromo Satinato Satin Chrome</p>	
	<p>Pomoli per mobile Cabinet knobs</p>  <p>160</p>	21	20	17	19	<p>Oro Lucido Polished Brass</p> <hr/> <p>Bronzo Antico Antique Bronze</p> <hr/> <p>Nickel Lucido Nickel Plated</p> <hr/> <p>Nickel Satinato Satin Nickel</p> <hr/> <p>Cromo Lucido Chrome Plated</p> <hr/> <p>Cromo Satinato Satin Chrome</p>

Articolo
Item

Misure
Sizes

Finitura
Finish

A B C D

Pomoli per mobile
Cabinet knobs

Oro Lucido
Polished Brass

Bronzo Antico
Antique Bronze

Nickel Lucido
Nickel Plated

26 25 20 21

Nickel Satinato
Satin Nickel

Cromo Lucido
Chrome Plated

Cromo Satinato
Satin Chrome

Oro Lucido
Polished Brass

Bronzo Antico
Antique Bronze

Nickel Lucido
Nickel Plated

32 32 26 23

Nickel Satinato
Satin Nickel

Cromo Lucido
Chrome Plated

Cromo Satinato
Satin Chrome

Oro Lucido
Polished Brass

Bronzo Antico
Antique Bronze

Nickel Lucido
Nickel Plated

40 40 30 26

Nickel Satinato
Satin Nickel

Cromo Lucido
Chrome Plated

Cromo Satinato
Satin Chrome

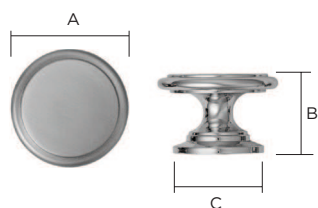

160

Pomoli per mobile
Cabinet knobs

Oro Lucido
Polished Brass

Bronzo Antico
Antique Bronze

Nickel Lucido
Nickel Plated

17 17 17 15

Nickel Satinato
Satin Nickel

Cromo Lucido
Chrome Plated

Cromo Satinato
Satin Chrome

Oro Lucido
Polished Brass

Bronzo Antico
Antique Bronze

Nickel Lucido
Nickel Plated

21 20 20 17

Nickel Satinato
Satin Nickel

Cromo Lucido
Chrome Plated

Cromo Satinato
Satin Chrome

Oro Lucido
Polished Brass

Bronzo Antico
Antique Bronze

Nickel Lucido
Nickel Plated

26 25 23 20

Nickel Satinato
Satin Nickel

Cromo Lucido
Chrome Plated

Cromo Satinato
Satin Chrome

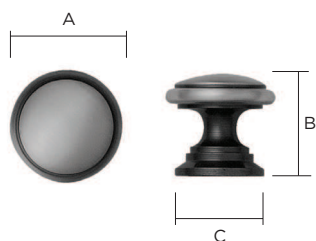

161

Articolo
Item

Misure
Sizes

Finitura
Finish

A B C D

Pomoli per mobile
Cabinet knobs

Oro Lucido
Polished Brass

Bronzo Antico
Antique Bronze

Nickel Lucido
Nickel Plated

Nickel Satinato
Satin Nickel

Cromo Lucido
Chrome Plated

Cromo Satinato
Satin Chrome

32 32 26 26

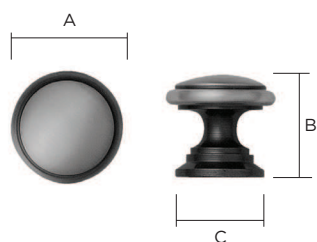

161

Oro Lucido
Polished Brass

Bronzo Antico
Antique Bronze

Nickel Lucido
Nickel Plated

Nickel Satinato
Satin Nickel

Cromo Lucido
Chrome Plated

Cromo Satinato
Satin Chrome

40 40 29 30

Pomoli per mobile
Cabinet knobs

Oro Lucido
Polished Brass

Nickel Lucido
Nickel Plated

Nickel Satinato
Satin Nickel

Cromo Lucido
Chrome Plated

Cromo Satinato
Satin Chrome

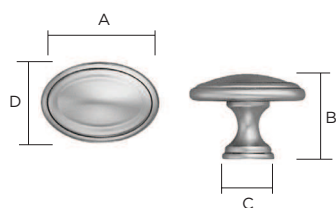

163

30 30 22 13 21



Articolo
Item

Misure
Sizes

Finitura
Finish

A B C D

Pomoli per mobile
Cabinet knobs

Oro Lucido
Polished Brass

Nickel Lucido
Nickel Plated

35 35 26 16 24

Nickel Satinato
Satin Nickel

Cromo Lucido
Chrome Plated

Cromo Satinato
Satin Chrome

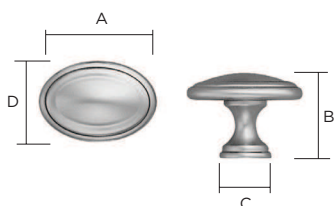

163

Oro Lucido
Polished Brass

Nickel Lucido
Nickel Plated

40 40 30 18 28

Nickel Satinato
Satin Nickel

Cromo Lucido
Chrome Plated

Cromo Satinato
Satin Chrome

Pomoli per mobile
Cabinet knobs

Oro Lucido
Polished Brass

25 25 18 15

Bronzo Antico
Antique Bronze

Oro Lucido
Polished Brass

30 30 22 18

Bronzo Antico
Antique Bronze

Oro Lucido
Polished Brass

35 35 25 21

Bronzo Antico
Antique Bronze

Oro Lucido
Polished Brass

40 40 28 24

Bronzo Antico
Antique Bronze

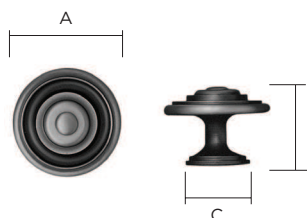

164

Pomoli per mobile
Cabinet knobs

15

15

20

14

Oro Lucido
Polished Brass

Bronzo Antico
Antique Bronze

Nickel Lucido
Nickel Plated

Nickel Satinato
Satin Nickel

Cromo Lucido
Chrome Plated

Cromo Satinato
Satin Chrome

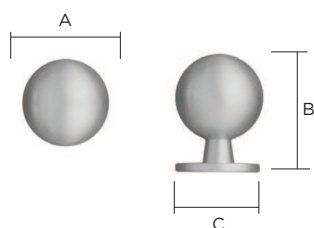

165

20

20

27

19

Oro Lucido
Polished Brass

Bronzo Antico
Antique Bronze

Nickel Lucido
Nickel Plated

Nickel Satinato
Satin Nickel

Cromo Lucido
Chrome Plated

Cromo Satinato
Satin Chrome

Oro Lucido
Polished Brass

Bronzo Antico
Antique Bronze

Nickel Lucido
Nickel Plated

Nickel Satinato
Satin Nickel

Cromo Lucido
Chrome Plated

Cromo Satinato
Satin Chrome

25

25

33

24

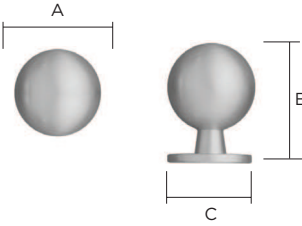
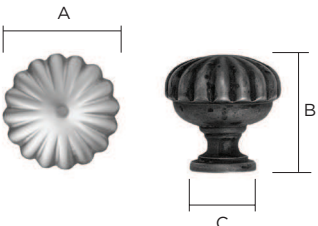

Articolo Item	Misure Sizes				Finitura Finish
	A	B	C	D	
<p>Pomoli per mobile Cabinet knobs</p>  <p>165</p>	30	30	39	29	Oro Lucido Polished Brass
					Bronzo Antico Antique Bronze
					Nickel Lucido Nickel Plated
					Nickel Satinato Satin Nickel
					Cromo Lucido Chrome Plated
	Cromo Satinato Satin Chrome				
	35	35	45	34	Oro Lucido Polished Brass
					Bronzo Antico Antique Bronze
					Nickel Lucido Nickel Plated
					Nickel Satinato Satin Nickel
Cromo Lucido Chrome Plated					
Cromo Satinato Satin Chrome					
<p>Pomoli per mobile Cabinet knobs</p>  <p>168</p>	25	26	26	16	Oro Lucido Polished Brass
					Bronzo Antico Antique Bronze
					Ottone Antico Ancient Brass
	30	30	30	17	Oro Lucido Polished Brass
					Bronzo Antico Antique Bronze
					Ottone Antico Ancient Brass
	35	35	35	19	Oro Lucido Polished Brass
					Bronzo Antico Antique Bronze
	Ottone Antico Ancient Brass				

Articolo
Item

Misure
Sizes

Finitura
Finish

A

B

C

D

Pomoli per mobile
Cabinet knobs

Oro Lucido
Polished Brass

Bronzo Antico
Antique Bronze

25 25 25 14

Cromo Lucido
Chrome Plated

Cromo Satinato
Satin Chrome

Oro Lucido
Polished Brass

Bronzo Antico
Antique Bronze

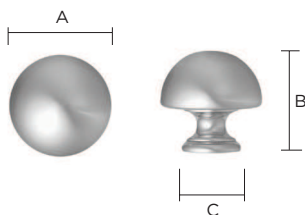

170

30 30 30 17

Cromo Lucido
Chrome Plated

Cromo Satinato
Satin Chrome





Oro Lucido
Polished Brass

Bronzo Antico
Antique Bronze

35 35 35 20



Cromo Lucido
Chrome Plated

Cromo Satinato
Satin Chrome

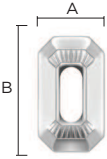
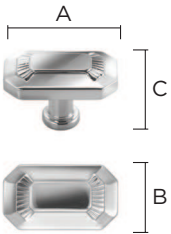
Articolo Item	Misure Sizes				Finitura Finish
	A	B	C	D	
<p>Pomoli per mobile Cabinet knobs</p>  <p>C02990 PO</p>					<p>Oro Lucido Polished Brass</p> <hr/> <p>Nickel Lucido Nickel Plated</p> <hr/> <p>Cromo Lucido Chrome Plated</p>
<p>Pomoli per mobile Cabinet knobs</p>  <p>C03090 PO</p>	30	30	24		<p>Oro Lucido Polished Brass</p> <hr/> <p>Bagno Oro Gold Plated</p> <hr/> <p>Cromo Lucido Chrome Plated</p>
<p>Pomoli per mobile Cabinet knobs</p>  <p>C03090 PO SW</p>	30	30	24		<p>Oro Lucido Polished Brass</p> <hr/> <p>Bagno Oro Gold Plated</p> <hr/> <p>Cromo Lucido Chrome Plated</p>
<p>Pomoli per mobile Cabinet knobs</p>  <p>C03090 PO SW</p>	40	40	32		<p>Oro Lucido Polished Brass</p> <hr/> <p>Bagno Oro Gold Plated</p> <hr/> <p>Cromo Lucido Chrome Plated</p>

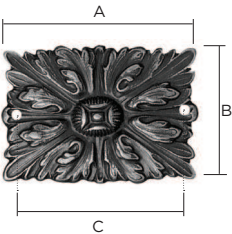
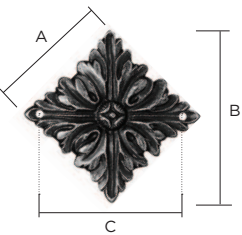
	Articolo Item	Misure Sizes				Finitura Finish
		A	B	C	D	
	Bocchetta per mobile Cabinet escutcheons					Oro Lucido Polished Brass
	C17890 BO	24	42			Nickel Lucido Nickel Plated
						Cromo Lucido Chrome Plated
	Pomoli per mobile Cabinet knobs					Oro Lucido Polished Brass
		30	33	19	25	Nickel Lucido Nickel Plated
						Cromo Lucido Chrome Plated
	C17890 PO					Oro Lucido Polished Brass
		42	42	24	27	Nickel Lucido Nickel Plated
						Cromo Lucido Chrome Plated

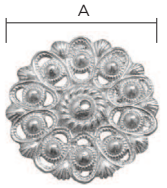
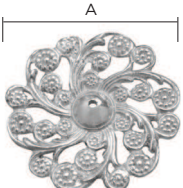
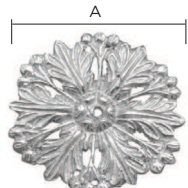
Articolo Item	Misure Sizes				Finitura Finish
	A	B	C	D	
<p>Fregi, cimase e fregi per pedino mobile Cabinet Decorations</p> <p>200</p> 	19	19	15		<p>Oro Lucido Polished Brass</p> <hr/> <p>Bronzo Antico Etrusco Etruscan Antique Bronze</p>
	24		19		<p>Oro Lucido Polished Brass</p> <hr/> <p>Bronzo Antico Etrusco Etruscan Antique Bronze</p>
	28	27	22		<p>Oro Lucido Polished Brass</p> <hr/> <p>Bronzo Antico Etrusco Etruscan Antique Bronze</p>
	33	33	27		<p>Oro Lucido Polished Brass</p> <hr/> <p>Bronzo Antico Etrusco Etruscan Antique Bronze</p>
	42	43	35		<p>Oro Lucido Polished Brass</p> <hr/> <p>Bronzo Antico Etrusco Etruscan Antique Bronze</p>
<p>Fregi, cimase e fregi per pedino mobile Cabinet Decorations</p> <p>207</p> 	48	48	33	42	<p>Oro Lucido Polished Brass</p> <hr/> <p>Bronzo Antico Etrusco Etruscan Antique Bronze</p>
	70	70	50	62	<p>Oro Lucido Polished Brass</p> <hr/> <p>Bronzo Antico Etrusco Etruscan Antique Bronze</p>
<p>Fregi, cimase e fregi per pedino mobile Cabinet Decorations</p> <p>208</p> 	30	30	42	32	<p>Oro Lucido Polished Brass</p> <hr/> <p>Bronzo Antico Etrusco Etruscan Antique Bronze</p>
	40	40	56	45	<p>Oro Lucido Polished Brass</p> <hr/> <p>Bronzo Antico Etrusco Etruscan Antique Bronze</p>

	Articolo Item	Misure Sizes				Finitura Finish
		A	B	C	D	
	Fregi, cimase e fregi per pedino mobile Cabinet Decorations 209	36	36			Oro Lucido Polished Brass Bronzo Antico Etrusco Etruscan Antique Bronze
	Fregi, cimase e fregi per pedino mobile Cabinet Decorations 210	35	35			Oro Lucido Polished Brass Bronzo Antico Etrusco Etruscan Antique Bronze
	Fregi, cimase e fregi per pedino mobile Cabinet Decorations 211	48	48			Oro Lucido Polished Brass Bronzo Antico Etrusco Etruscan Antique Bronze
	Fregi, cimase e fregi per pedino mobile Cabinet Decorations 212	43	43			Oro Lucido Polished Brass Bronzo Antico Etrusco Etruscan Antique Bronze
	Fregi, cimase e fregi per pedino mobile Cabinet Decorations 213	46	46			Oro Lucido Polished Brass Bronzo Antico Etrusco Etruscan Antique Bronze

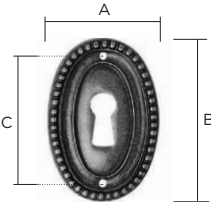
Articolo Item	Misure Sizes				Finitura Finish
	A	B	C	D	
<p>Bocchette per mobile Cabinet escutcheons</p>  <p>300</p>	29	20	29	22	Oro Lucido Polished Brass
	37	26	37	28	Bronzo Antico Etrusco Etruscan Antique Bronze
	47	32	47	36	Oro Lucido Polished Brass
					Bronzo Antico Etrusco Etruscan Antique Bronze

<p>Fregi, cimase e fregi per piedino mobile Cabinet Decorations</p>  <p>302</p>	240	47			Oro Lucido Polished Brass
					Bronzo Antico Etrusco Etruscan Antique Bronze

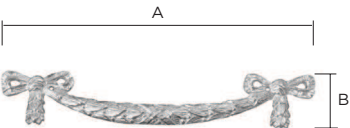
<p>Fregi, cimase e fregi per piedino mobile Cabinet Decorations</p>  <p>303</p>	158	29			Oro Lucido Polished Brass
					Bronzo Antico Etrusco Etruscan Antique Bronze

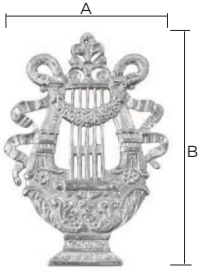
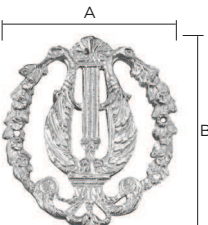
	Articolo Item	Misure Sizes				Finitura Finish
		A	B	C	D	
	Bocchette per mobile Cabinet escutcheons					Oro Lucido Polished Brass
	310 V	90	16	90		Bronzo Antico Etrusco Etruscan Antique Bronze
	Left/Right					Oro Lucido Polished Brass
		170	25	166		Bronzo Antico Etrusco Etruscan Antique Bronze
	Fregi, cimase e fregi per pedino mobile Cabinet Decorations					Oro Lucido Polished Brass
	329		87	131		Bronzo Antico Etrusco Etruscan Antique Bronze
	Fregi, cimase e fregi per pedino mobile Cabinet Decorations					Oro Lucido Polished Brass
	331		60	71		Bronzo Antico Etrusco Etruscan Antique Bronze

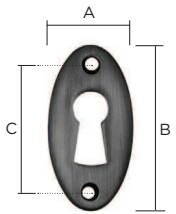
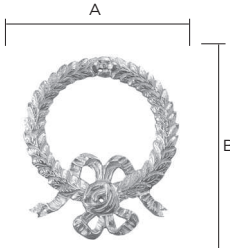
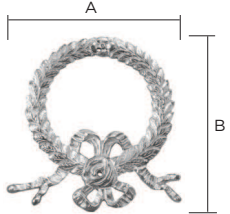
	Articolo Item	Misure Sizes				Finitura Finish
		A	B	C	D	
	<p>Bocchette per mobile Cabinet escutcheons</p> <p>332</p>	35	18	35	26	<p>Oro Lucido Polished Brass</p> <hr/> <p>Bronzo Antico Antique Bronze</p> <hr/> <p>Nickel Lucido Nickel Plated</p> <hr/> <p>Nickel Satinato Satin Nickel</p> <hr/> <p>Cromo Lucido Chrome Plated</p> <hr/> <p>Cromo Satinato Satin Chrome</p>
	<p>Fregi, cimase e fregi per piedino mobile Cabinet Decorations</p> <p>333</p>		48	58		<p>Oro Lucido Polished Brass</p> <hr/> <p>Bronzo Antico Etrusco Etruscan Antique Bronze</p>
	<p>Fregi, cimase e fregi per piedino mobile Cabinet Decorations</p> <p>334</p>		88	92		<p>Oro Lucido Polished Brass</p> <hr/> <p>Bronzo Antico Etrusco Etruscan Antique Bronze</p>

Articolo
Item

Misure
Sizes

Finitura
Finish

A

B

C

D



Fregi, cimase e fregi per
pedino mobile
Cabinet Decorations

335

30

158

Oro Lucido
Polished Brass

Bronzo Antico Etrusco
Etruscan Antique Bronze

Bocchette per mobile
Cabinet escutcheons

25

25

17

Oro Lucido
Polished Brass

Bronzo Antico
Antique Bronze

Nickel Lucido
Nickel Plated

Nickel Satinato
Satin Nickel



336

30

30

23

Oro Lucido
Polished Brass

Bronzo Antico
Antique Bronze

Nickel Lucido
Nickel Plated

Nickel Satinato
Satin Nickel

Oro Lucido
Polished Brass

Bronzo Antico
Antique Bronze



Nickel Lucido
Nickel Plated

Nickel Satinato
Satin Nickel

35

35

25

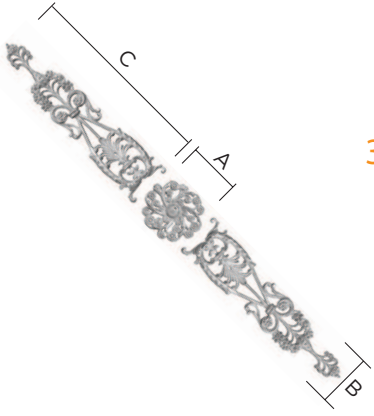
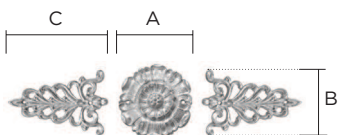
	Articolo Item	Misure Sizes				Finitura Finish
		A	B	C	D	
	<p>Fregi, cimase e fregi per piedino mobile Cabinet Decorations</p> <p>342</p>	71	147			<p>Oro Lucido Polished Brass</p> <hr/> <p>Bronzo Antico Etrusco Etruscan Antique Bronze</p>
	<p>Fregi, cimase e fregi per piedino mobile Cabinet Decorations</p> <p>343</p>	22	166			<p>Oro Lucido Polished Brass</p> <hr/> <p>Bronzo Antico Etrusco Etruscan Antique Bronze</p>
	<p>Fregi, cimase e fregi per piedino mobile Cabinet Decorations</p> <p>344</p>	48	35	167		<p>Oro Lucido Polished Brass</p> <hr/> <p>Bronzo Antico Etrusco Etruscan Antique Bronze</p>
	<p>Fregi, cimase e fregi per piedino mobile Cabinet Decorations</p> <p>345</p>	46	35	69		<p>Oro Lucido Polished Brass</p> <hr/> <p>Bronzo Antico Etrusco Etruscan Antique Bronze</p>

Articolo
Item

Misure
Sizes

Finitura
Finish

A

B

C

D

Fregi, cimase e fregi per
pedino mobile
Cabinet Decorations

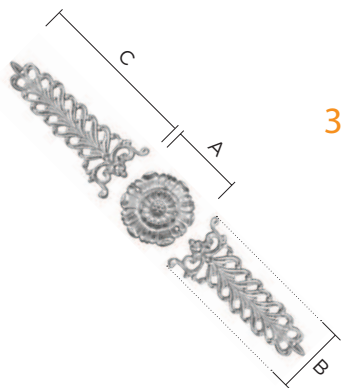

346

46 41 104

Oro Lucido
Polished Brass

Bronzo Antico Etrusco
Etruscan Antique Bronze

Fregi, cimase e fregi per
pedino mobile
Cabinet Decorations

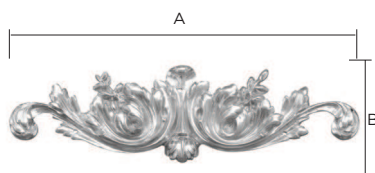

347

260 77

Oro Lucido
Polished Brass

Bronzo Antico Etrusco
Etruscan Antique Bronze

Fregi, cimase e fregi per
pedino mobile
Cabinet Decorations

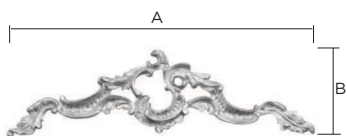

348

232 67

Oro Lucido
Polished Brass

Bronzo Antico Etrusco
Etruscan Antique Bronze

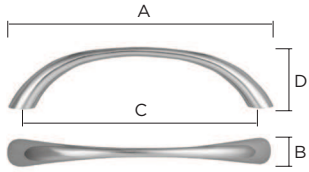
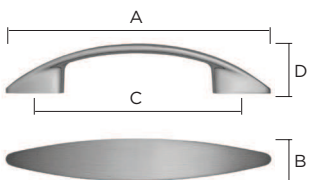
Articolo Item	Misure Sizes				Finitura Finish	
	A	B	C	D		
<p>Maniglie per mobile Cabinet handles</p>  <p>400</p>	32	42	9	32	16	Oro Lucido Polished Brass
						Nickel Satinato Satin Nickel
						Cromo Lucido Chrome Plated
						Cromo Satinato Satin Chrome
	64	78	11	64	24	Oro Lucido Polished Brass
						Nickel Satinato Satin Nickel
						Cromo Lucido Chrome Plated
						Cromo Satinato Satin Chrome
	96	110	11	96	24	Oro Lucido Polished Brass
						Nickel Satinato Satin Nickel
						Cromo Lucido Chrome Plated
						Cromo Satinato Satin Chrome
<p>Maniglie per mobile Cabinet handles</p>  <p>406</p>	96	125	20	96	24	Oro Lucido Polished Brass
						Nickel Satinato Satin Nickel
						Cromo Lucido Chrome Plated
						Cromo Satinato Satin Chrome
	160	200	22	160	26	Oro Lucido Polished Brass
						Nickel Satinato Satin Nickel
						Cromo Lucido Chrome Plated
						Cromo Satinato Satin Chrome

Articolo
Item

Misure
Sizes

Finitura
Finish

A

B

C

D

Maniglie per mobile
Cabinet handles

Oro Lucido
Polished Brass

65 83 33 65

Bronzo Antico Etrusco
Etruscan Antique Bronze

Oro Antico
Old Gold

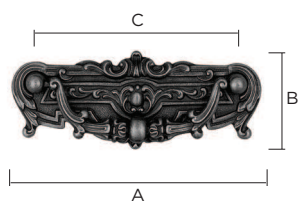

412

80 10 39 80

Oro Lucido
Polished Brass

Bronzo Antico Etrusco
Etruscan Antique Bronze

Oro Antico
Old Gold

90 113 45 90

Oro Lucido
Polished Brass

Bronzo Antico Etrusco
Etruscan Antique Bronze

Oro Antico
Old Gold

Maniglie per mobile
Cabinet handles

Oro Lucido
Polished Brass

65 82 30 65

Bronzo Antico Etrusco
Etruscan Antique Bronze

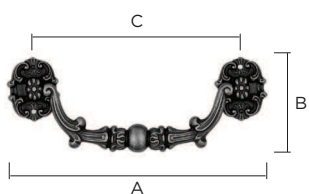

413

80 102 38 80



Oro Lucido
Polished Brass

Bronzo Antico Etrusco
Etruscan Antique Bronze

90 112 41 90

Oro Lucido
Polished Brass

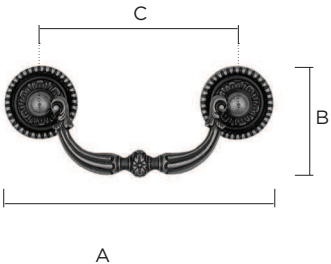
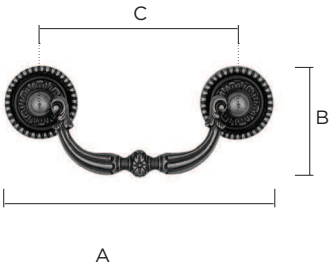
Bronzo Antico Etrusco
Etruscan Antique Bronze

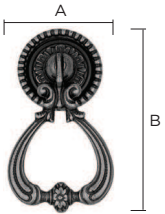
Articolo Item	Misure Sizes				Finitura Finish
	A	B	C	D	
Maniglie per mobile Cabinet handles 					Oro Lucido Polished Brass
	75	103	42	75	Bronzo Antico Etrusco Etruscan Antique Bronze
					Oro Antico Old Gold
420 	95	129	52	95	Oro Lucido Polished Brass
					Bronzo Antico Etrusco Etruscan Antique Bronze
					Oro Antico Old Gold
Bocchette per mobile Cabinet escutcheons 					Oro Lucido Polished Brass
	421	33		24	Bronzo Antico Etrusco Etruscan Antique Bronze
					Oro Antico Old Gold
Maniglie per mobile Cabinet handles 					Oro Lucido Polished Brass
	422	35		64	Bronzo Antico Etrusco Etruscan Antique Bronze
					Oro Antico Old Gold

Articolo
Item

Misure
Sizes

Finitura
Finish

A B C D

Maniglie per mobile
Cabinet handles

Oro Lucido
Polished Brass

90 91 28 63

Bronzo Antico Etrusco
Etruscan Antique Bronze

Oro Antico
Old Gold

Oro Lucido
Polished Brass

130 129 34 92

Bronzo Antico Etrusco
Etruscan Antique Bronze

Oro Antico
Old Gold

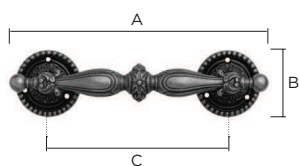

423

Oro Lucido
Polished Brass

190 194 51 139

Bronzo Antico Etrusco
Etruscan Antique Bronze



Oro Antico
Old Gold



Oro Lucido
Polished Brass

240 244 51 174

Bronzo Antico Etrusco
Etruscan Antique Bronze

Oro Antico
Old Gold

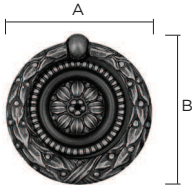
Articolo Item	Misure Sizes				Finitura Finish
	A	B	C	D	
<p>Maniglie per mobile Cabinet handles</p>  <p>424</p>	50	28	68		<p>Oro Lucido Polished Brass</p> <hr/> <p>Bronzo Antico Etrusco Etruscan Antique Bronze</p> <hr/> <p>Oro Antico Old Gold</p>
	70	40	92		<p>Oro Lucido Polished Brass</p> <hr/> <p>Bronzo Antico Etrusco Etruscan Antique Bronze</p> <hr/> <p>Oro Antico Old Gold</p>
<p>Maniglie per mobile Cabinet handles</p>  <p>425</p>	95	25	107		<p>Oro Lucido Polished Brass</p> <hr/> <p>Bronzo Antico Etrusco Etruscan Antique Bronze</p> <hr/> <p>Oro Antico Old Gold</p>
	120	30	136		<p>Oro Lucido Polished Brass</p> <hr/> <p>Bronzo Antico Etrusco Etruscan Antique Bronze</p> <hr/> <p>Oro Antico Old Gold</p>
<p>Maniglie per mobile Cabinet handles</p>  <p>432</p>	96	127	46	96	<p>Oro Lucido Polished Brass</p> <hr/> <p>Bronzo Antico Etrusco Etruscan Antique Bronze</p>

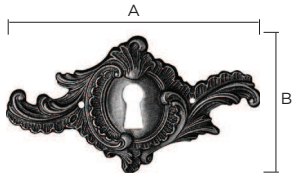
	Articolo Item	Misure Sizes				Finitura Finish
		A	B	C	D	
	Maniglie per mobile Cabinet handles	433	50	50	53	Oro Lucido Polished Brass
						Bronzo Antico Etrusco Etruscan Antique Bronze
	Maniglie per mobile Cabinet handles	435	100	100	37	Oro Lucido Polished Brass
						Bronzo Antico Etrusco Etruscan Antique Bronze
						Oro Lucido Polished Brass
						Bronzo Antico Etrusco Etruscan Antique Bronze
		125	120	42		Oro Lucido Polished Brass
						Bronzo Antico Etrusco Etruscan Antique Bronze
		160	160	52		Oro Lucido Polished Brass
						Bronzo Antico Etrusco Etruscan Antique Bronze
		210	210	68		Oro Lucido Polished Brass
						Bronzo Antico Etrusco Etruscan Antique Bronze
	Bocchette per mobile Cabinet escutcheons	437	85	85	45	Oro Lucido Polished Brass
						Bronzo Antico Etrusco Etruscan Antique Bronze

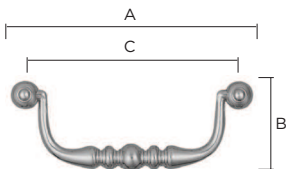
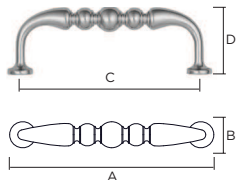
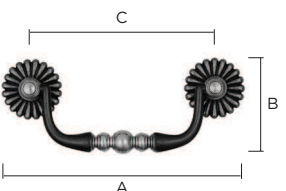
Articolo Item	Misure Sizes				Finitura Finish	
	A	B	C	D		
<p>Maniglie per mobile Cabinet handles</p>  <p>440</p>	64	68	26	58	Oro Lucido Polished Brass	
					Bronzo Antico Antique Bronze	
	72	85	37	75	Oro Lucido Polished Brass	
					Bronzo Antico Antique Bronze	
	100	113	42	100	Oro Lucido Polished Brass	
					Bronzo Antico Antique Bronze	
	115	128	47	115	Oro Lucido Polished Brass	
					Bronzo Antico Antique Bronze	
<p>Maniglie per mobile Cabinet handles</p>  <p>441</p>	110	110	14	96	36	Oro Lucido Polished Brass
						Bronzo Antico Antique Bronze
<p>Maniglie per mobile Cabinet handles</p>  <p>443</p>	72	72	39	96	Oro Lucido Polished Brass	
						Bronzo Antico Antique Bronze
	100	100	52	133	Oro Lucido Polished Brass	
					Bronzo Antico Antique Bronze	

Articolo
Item

Misure
Sizes

A B C D

Finitura
Finish

Maniglie per mobile
Cabinet handles

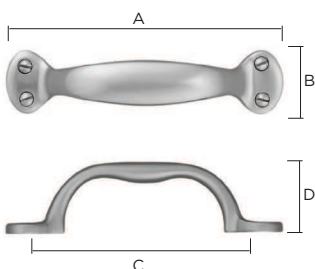

451

64 64 26 100

Oro Lucido
Polished Brass

Bronzo Antico
Antique Bronze

Ottone Antico
Ancient Brass

Nickel Satinato
Satin Nickel

Cromo Lucido
Chrome Plated

Cromo Satinato
Satin Chrome

Oro Lucido
Polished Brass

Bronzo Antico
Antique Bronze

Ottone Antico
Ancient Brass

Nickel Satinato
Satin Nickel

Cromo Lucido
Chrome Plated

Cromo Satinato
Satin Chrome

96 96 34 144

Maniglie per mobile
Cabinet handles

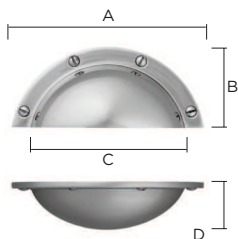

454

64 92 39 64 23

Oro Lucido
Polished Brass



Bronzo Antico
Antique Bronze

Ottone Antico
Ancient Brass

Nickel Satinato
Satin Nickel

Cromo Lucido
Chrome Plated

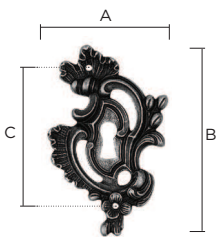
Cromo Satinato
Satin Chrome

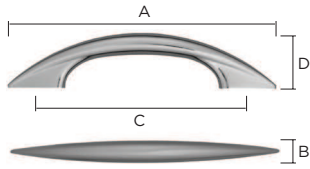
	Articolo Item	Misure Sizes				Finitura Finish
		A	B	C	D	
	Bocchette per mobile Cabinet escutcheons 455	55	37	56	45	Oro Lucido Polished Brass
						Bronzo Antico Etrusco Etruscan Antique Bronze
	Maniglie per mobile Cabinet handles 456	100	101	28		Oro Lucido Polished Brass
						Bronzo Antico Etrusco Etruscan Antique Bronze
						Oro Lucido Polished Brass
						Bronzo Antico Etrusco Etruscan Antique Bronze
	Maniglie per mobile Cabinet handles 461	96	147	12	96	30
						Oro Lucido Polished Brass
						Nickel Satinato Satin Nickel
						Cromo Lucido Chrome Plated
						Cromo Satinato Satin Chrome
						Oro Lucido Polished Brass
<td rowspan="4">160</td> <td rowspan="4">208</td> <td rowspan="4">14</td> <td rowspan="4">160</td> <td rowspan="4">32</td> <td>Nickel Satinato Satin Nickel</td>	160	208	14	160	32	Nickel Satinato Satin Nickel
						Cromo Lucido Chrome Plated
						Cromo Satinato Satin Chrome
						Cromo Satinato Satin Chrome

Articolo
Item

Misure
Sizes

Finitura
Finish

A

B

C

D

Pomoli per mobile
Cabinet knobs

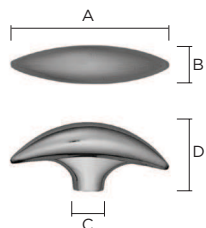

461 P

48

12

12

21

Oro Lucido
Polished Brass

Nickel Satinato
Satin Nickel

Cromo Lucido
Chrome Plated

Cromo Satinato
Satin Chrome

Maniglie per mobile
Cabinet handles

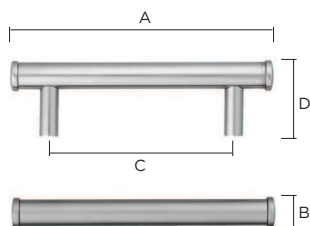

464

96

136

16

96

40

Oro Lucido
Polished Brass

Bronzo Antico
Antique Bronze

Nickel Satinato
Satin Nickel

Cromo Lucido
Chrome Plated

Cromo Satinato
Satin Chrome

Oro Lucido
Polished Brass

Bronzo Antico
Antique Bronze

Nickel Satinato
Satin Nickel

Cromo Lucido
Chrome Plated

Cromo Satinato
Satin Chrome

128

168

16

128

40

Oro Lucido
Polished Brass

Bronzo Antico
Antique Bronze

Nickel Satinato
Satin Nickel

Cromo Lucido
Chrome Plated

Cromo Satinato
Satin Chrome

160

200

16

160

40

Articolo
Item

Misure
Sizes

A B C D

Finitura
Finish

Maniglie per mobile
Cabinet handles

Oro Lucido
Polished Brass

Bronzo Antico
Antique Bronze

192 232 16 192 40

Nickel Satinato
Satin Nickel

Cromo Lucido
Chrome Plated

Cromo Satinato
Satin Chrome

Oro Lucido
Polished Brass

Bronzo Antico
Antique Bronze

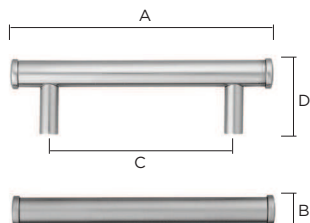

464

320 360 16 320 40

Nickel Satinato
Satin Nickel

Cromo Lucido
Chrome Plated

Cromo Satinato
Satin Chrome

Oro Lucido
Polished Brass



Bronzo Antico
Antique Bronze

480 520 16 480 40

Nickel Satinato
Satin Nickel

Cromo Lucido
Chrome Plated

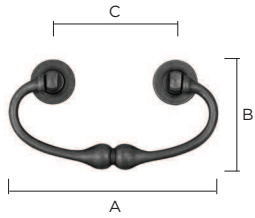
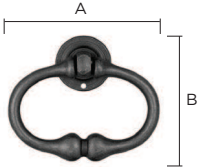
Cromo Satinato
Satin Chrome

	Articolo Item	Misure Sizes				Finitura Finish
		A	B	C	D	
	Maniglie per mobile Cabinet handles					Oro Lucido Polished Brass
	465	80	81	45	46	Bronzo Antico Etrusco Etruscan Antique Bronze
		100	101	52	60	Oro Lucido Polished Brass
						Bronzo Antico Etrusco Etruscan Antique Bronze
	Maniglie per mobile Cabinet handles					Oro Lucido Polished Brass
	466	60	58	48		Bronzo Antico Etrusco Etruscan Antique Bronze
	Maniglie per mobile Cabinet handles					Oro Lucido Polished Brass
	467	50	61	22		Bronzo Antico Etrusco Etruscan Antique Bronze

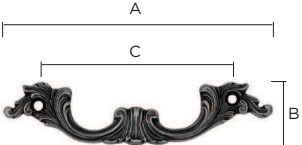
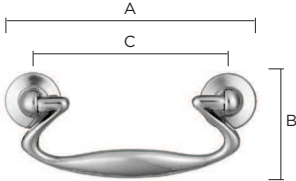
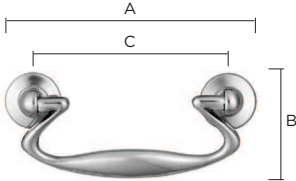
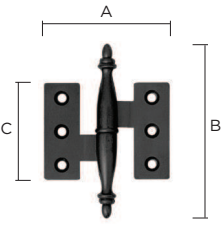
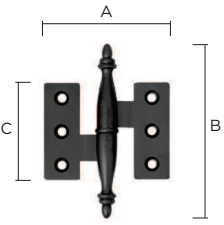
Articolo Item	Misure Sizes				Finitura Finish
	A	B	C	D	
<p>Maniglie per mobile Cabinet handles</p>  <p>470</p>	90	88	22	61	Oro Lucido Polished Brass
					Bronzo Antico Etrusco Etruscan Antique Bronze
<p>Maniglie per mobile Cabinet handles</p>  <p>472</p>	120	119	22	35	Oro Lucido Polished Brass
					Bronzo Antico Etrusco Etruscan Antique Bronze
<p>Maniglie per mobile Cabinet handles</p>  <p>472</p>	64	83	36	64	Oro Lucido Polished Brass
					Bronzo Antico Antique Bronze
<p>Cerniere mobile Cabinet hinges</p>  <p>473</p> <p>Left/Right</p>	96	115	50	96	Oro Lucido Polished Brass
					Bronzo Antico Antique Bronze
<p>Cerniere mobile Cabinet hinges</p>  <p>473</p> <p>Left/Right</p>	57	65	43		Oro Lucido Polished Brass
					Bronzo Antico Antique Bronze

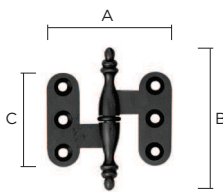
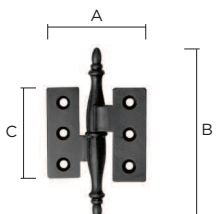
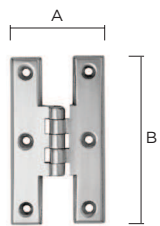
Articolo Item	Misure Sizes				Finitura Finish
	A	B	C	D	
<p>Cerniere mobile Cabinet hinges</p>  <p>473 BA</p> <p>Left/Right</p>	57	65	43	<p>Oro Lucido Polished Brass</p> <hr/> <p>Bronzo Antico Antique Bronze</p>	
<p>Cerniere mobile Cabinet hinges</p>  <p>473 BIS</p> <p>Left/Right</p>	48	66	43	<p>Oro Lucido Polished Brass</p> <hr/> <p>Bronzo Antico Antique Bronze</p>	
<p>Cerniere mobile Cabinet hinges</p>  <p>474</p>	63	35	63	<p>Oro Lucido Polished Brass</p> <hr/> <p>Bronzo Antico Antique Bronze</p>	
	75	35	76	<p>Oro Lucido Polished Brass</p> <hr/> <p>Bronzo Antico Antique Bronze</p>	

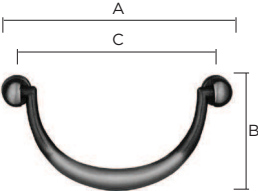
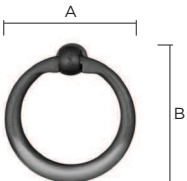
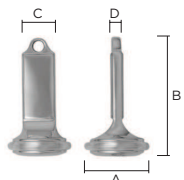
Articolo Item	Misure Sizes				Finitura Finish	
	A	B	C	D		
<p>Maniglie per mobile Cabinet handles</p>  <p>489</p>	75	82	40	72	Oro Lucido Polished Brass	
					Bronzo Antico Antique Bronze	
	100	97	50	87	Oro Lucido Polished Brass	
					Bronzo Antico Antique Bronze	
	<p>Maniglie per mobile Cabinet handles</p>  <p>499</p>	34	34	37	Oro Lucido Polished Brass	
						Bronzo Antico Antique Bronze
					Nickel Lucido Bright Nickel	
40		40	43		Oro Lucido Polished Brass	
					Bronzo Antico Antique Bronze	
					Nickel Lucido Bright Nickel	
<p>Portachiavi Hotel key-rings</p>  <p>510</p>	85	45	85	24	9	Oro Lucido Polished Brass
						Cromo Lucido Chrome Plated

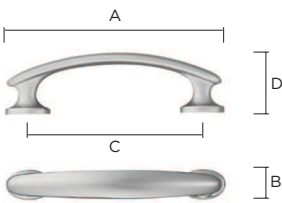
	Articolo Item	Misure Sizes				Finitura Finish
		A	B	C	D	
	Portachiavi Hotel key-rings					Oro Lucido Polished Brass
	511	36		80		Cromo Lucido Chrome Plated
	Maniglie per mobile Cabinet handles					Oro Lucido Polished Brass
						Bronzo Antico Antique Bronze
	64	81	11	64	22	Nickel Satinato Satin Nickel
						Cromo Lucido Chrome Plated
						Cromo Satinato Satin Chrome
						Oro Lucido Polished Brass
						Bronzo Antico Antique Bronze
	96	121	15	96	27	Nickel Satinato Satin Nickel
						Cromo Lucido Chrome Plated
						Cromo Satinato Satin Chrome
						Oro Lucido Polished Brass
						Bronzo Antico Antique Bronze
192	215	15	192	27	Nickel Satinato Satin Nickel	
					Cromo Lucido Chrome Plated	
					Cromo Satinato Satin Chrome	

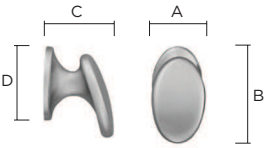
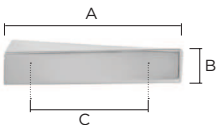
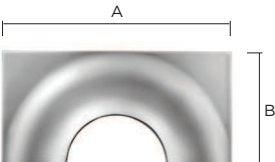
Articolo Item	Misure Sizes				Finitura Finish
	A	B	C	D	
<p>Pomoli per mobile Cabinet knobs</p>  <p>523</p>	18	30	23	25	<p>Oro Lucido Polished Brass</p> <hr/> <p>Bronzo Antico Antique Bronze</p> <hr/> <p>Nickel Satinato Satin Nickel</p> <hr/> <p>Cromo Lucido Chrome Plated</p> <hr/> <p>Cromo Satinato Satin Chrome</p>
<p>Maniglie per mobile Cabinet handles</p>  <p>526</p>	32	46	18	32	<p>Oro Lucido Polished Brass</p> <hr/> <p>Cromo Lucido Chrome Plated</p> <hr/> <p>Cromo Satinato Satin Chrome</p>
<p>Maniglie per mobile Cabinet handles</p>  <p>529</p>	64	130	64		<p>Oro Lucido Polished Brass</p> <hr/> <p>Nickel Satinato Satin Nickel</p> <hr/> <p>Cromo Lucido Chrome Plated</p> <hr/> <p>Cromo Satinato Satin Chrome</p>

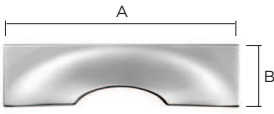
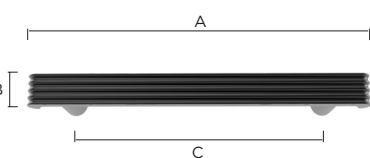
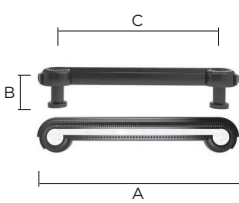
	Articolo Item	Misure Sizes				Finitura Finish
		A	B	C	D	
	Maniglie per mobile Cabinet handles 530	64	120	32	Oro Lucido Polished Brass	
					Nickel Satinato Satin Nickel	
					Cromo Lucido Chrome Plated	
					Cromo Satinato Satin Chrome	
	Maniglia per mobile Cabinet handles C02990				Oro Lucido Polished Brass	
					Nickel Lucido Nickel Plated	
					Cromo Lucido Chrome Plated	
					Oro Lucido Polished Brass	
					Nickel Lucido Nickel Plated	
					Cromo Lucido Chrome Plated	
					Oro Lucido Polished Brass	
					Nickel Lucido Nickel Plated	
					Cromo Lucido Chrome Plated	
					Oro Lucido Polished Brass	
					Nickel Lucido Nickel Plated	
					Cromo Lucido Chrome Plated	
	Maniglia per mobile Cabinet handles C03090				Oro Lucido Polished Brass	
					Bagno Oro Gold Plated	
					Cromo Lucido Chrome Plated	
					Oro Lucido Polished Brass	
					Bagno Oro Gold Plated	
					Cromo Lucido Chrome Plated	

Maniglia per mobile
Cabinet handles

Oro Lucido
Polished Brass

Bagno Oro
Gold Plated

Cromo Lucido
Chrome Plated

C03090 SW

Oro Lucido
Polished Brass

Bagno Oro
Gold Plated

Cromo Lucido
Chrome Plated

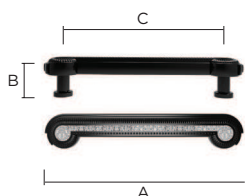

128 160 30 128

160 192 30 160

Maniglia per mobile
Cabinet handles

Oro Lucido
Polished Brass

Nickel Lucido
Nickel Plated

Cromo Lucido
Chrome Plated

C09590

Oro Lucido
Polished Brass

Nickel Lucido
Nickel Plated

Cromo Lucido
Chrome Plated

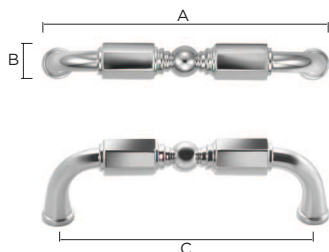

96 108 14 96

128 140 14 128

sporgenza
width = 36

Articolo
Item

Misure
Sizes

Finitura
Finish

A

B

C

D

Maniglia per mobile
Cabinet handles

Oro Lucido
Polished Brass

128 143 16 128

Nickel Lucido
Nickel Plated

Cromo Lucido
Chrome Plated

Oro Lucido
Polished Brass

C10190

192 207 16 192

Nickel Lucido
Nickel Plated

Cromo Lucido
Chrome Plated

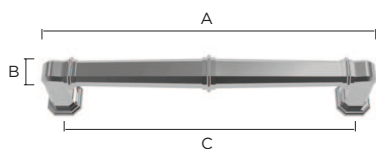

Oro Lucido
Polished Brass

320 335 16 320

Nickel Lucido
Nickel Plated

Cromo Lucido
Chrome Plated

Maniglia per mobile
Cabinet handles

Oro Lucido
Polished Brass

96 18 134 96

Nickel Lucido
Nickel Plated

Cromo Lucido
Chrome Plated

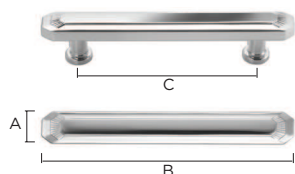

C17890

Oro Lucido
Polished Brass

128 18 166 128

Nickel Lucido
Nickel Plated

Cromo Lucido
Chrome Plated

sporgenza
width = 26

Maniglie per mobile
Cabinet handles

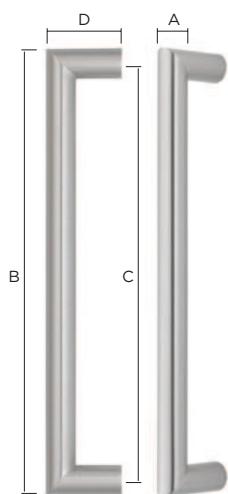

538 V

160 14 174 160 35

Cromo Lucido
Chrome Plated

Cromo Satinato
Satin Chrome

192 14 206 192 35

Cromo Lucido
Chrome Plated

Cromo Satinato
Satin Chrome

256 14 270 256 35

Cromo Lucido
Chrome Plated

Cromo Satinato
Satin Chrome

Maniglie incasso
per mobile
Cabinet flush handles

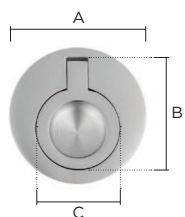

580

50 51

Oro Lucido
Polished Brass

Oro Satinato
Satin Brass

Bronzo Antico
Antique Bronze

Nickel Lucido
Nickel Platted

Nickel Satinato
Satin Nickel

Cromo Lucido
Chrome Plated

Cromo Satinato
Satin Chrome

Articolo
Item

Misure
Sizes

Finitura
Finish

A

B

C

D

Maniglie incasso
per mobile
Cabinet flush handles

Oro Lucido
Polished Brass

Oro Satinato
Satin Brass

40

30

40

24

32

Bronzo Antico
Antique Bronze

Nickel Lucido
Nickel Plated

Nickel Satinato
Satin Nickel

Oro Lucido
Polished Brass

Oro Satinato
Satin Brass

587

50

38

51

31

41

Bronzo Antico
Antique Bronze

Nickel Lucido
Nickel Plated

Nickel Satinato
Satin Nickel

Oro Lucido
Polished Brass

Oro Satinato
Satin Brass

60

47

60

36

47

Bronzo Antico
Antique Bronze

Nickel Lucido
Nickel Plated

Nickel Satinato
Satin Nickel

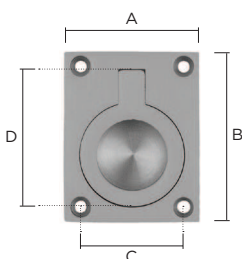

Articolo
Item

Misure
Sizes

A B C D

Finitura
Finish

Maniglie incasso
per mobile
Cabinet flush handles

Oro Lucido
Polished Brass

Oro Satinato
Satin Brass

40 30 40 24 32

Bronzo Antico
Antique Bronze

Nickel Lucido
Nickel Plated

Nickel Satinato
Satin Nickel

Oro Lucido
Polished Brass

Oro Satinato
Satin Brass

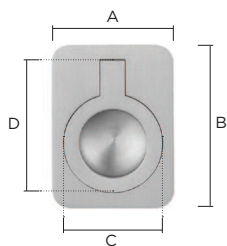

587 BA

50 38 51 31 41

Bronzo Antico
Antique Bronze

Nickel Lucido
Nickel Plated

Nickel Satinato
Satin Nickel

Oro Lucido
Polished Brass

Oro Satinato
Satin Brass

60 47 60 36 47

Bronzo Antico
Antique Bronze

Nickel Lucido
Nickel Plated

Nickel Satinato
Satin Nickel

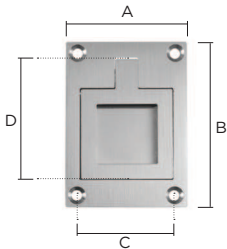
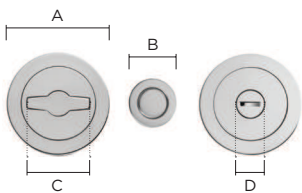
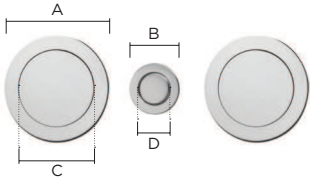
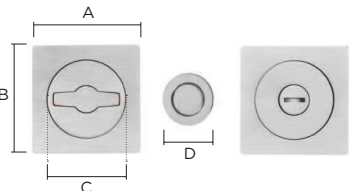
	Articolo Item	Misure Sizes				Finitura Finish	
		A	B	C	D		
	Maniglie incasso per mobile Cabinet flush handles 588	60	47	66	36	48	Oro Lucido Polished Brass Oro Satinato Satin Brass Nickel Lucido Nickel Plated Nickel Satinato Satin Nickel
	Maniglie incasso magnetiche Magnetic flush handles 589 AC kit pull	60	57	30	34	16	Oro Lucido Polished Brass Nickel Lucido Nickel Plated Nickel Satinato Satin Nickel Cromo Lucido Chrome Plated Cromo Satinato Satin Chrome
	Maniglie incasso magnetiche Magnetic flush handles 589 kit pull	60	57	30	41	19	Oro Lucido Polished Brass Nickel Lucido Nickel Plated Nickel Satinato Satin Nickel Cromo Lucido Chrome Plated Cromo Satinato Satin Chrome
	Maniglie incasso magnetiche Magnetic flush handles 590 AC kit pull	60	57	57	41	30	Oro Lucido Polished Brass Nickel Lucido Nickel Plated Nickel Satinato Satin Nickel Cromo Lucido Chrome Plated Cromo Satinato Satin Chrome

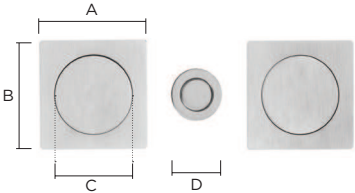
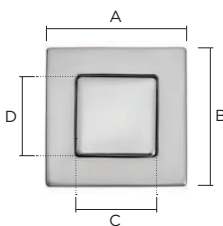
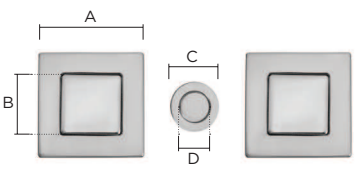
Articolo Item	Misure Sizes				Finitura Finish	
	A	B	C	D		
<p>Maniglie incasso magnetiche Magnetic flush handles</p>  <p>590 kit pull</p>	60	57	57	41	30	<p>Oro Lucido Polished Brass</p> <hr/> <p>Nickel Lucido Nickel Plated</p> <hr/> <p>Nickel Satinato Satin Nickel</p> <hr/> <p>Cromo Lucido Chrome Plated</p> <hr/> <p>Cromo Satinato Satin Chrome</p>
<p>Maniglie incasso magnetiche Magnetic flush handles</p>  <p>592</p>	50	52	52	30	30	<p>Oro Lucido Polished Brass</p> <hr/> <p>Nickel Lucido Nickel Plated</p> <hr/> <p>Nickel Satinato Satin Nickel</p> <hr/> <p>Cromo Lucido Chrome Plated</p> <hr/> <p>Cromo Satinato Satin Chrome</p>
<p>Maniglie incasso magnetiche Magnetic flush handles</p>  <p>592 kit pull</p>	50	52	30	30	19	<p>Oro Lucido Polished Brass</p> <hr/> <p>Nickel Lucido Nickel Plated</p> <hr/> <p>Nickel Satinato Satin Nickel</p> <hr/> <p>Cromo Lucido Chrome Plated</p> <hr/> <p>Cromo Satinato Satin Chrome</p>

Articolo
Item

Misure
Sizes

A B C D

Finitura
Finish

Maniglie incasso
magnetiche
Magnetic flush handles

Oro Lucido
Polished Brass

Nickel Lucido
Nickel Plated

140 45 140 25 80

Nickel Satinato
Satin Nickel

Cromo Lucido
Chrome Plated

Cromo Satinato
Satin Chrome

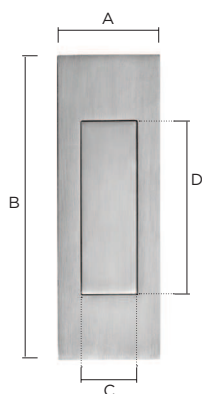

593

Oro Lucido
Polished Brass

Nickel Lucido
Nickel Plated

160 45 160 25 100

Nickel Satinato
Satin Nickel

Cromo Lucido
Chrome Plated

Cromo Satinato
Satin Chrome

Oro Lucido
Polished Brass

Nickel Lucido
Nickel Plated

200 45 200 25 140

Nickel Satinato
Satin Nickel

Cromo Lucido
Chrome Plated

Cromo Satinato
Satin Chrome

Maniglie incasso
magnetiche
Magnetic flush handles

Oro Lucido
Polished Brass

Nickel Lucido
Nickel Plated

140 45 140 25 80

Nickel Satinato
Satin Nickel

Cromo Lucido
Chrome Plated

Cromo Satinato
Satin Chrome

Oro Lucido
Polished Brass

Nickel Lucido
Nickel Plated

160 45 160 25 100

Nickel Satinato
Satin Nickel

Cromo Lucido
Chrome Plated

Cromo Satinato
Satin Chrome

Oro Lucido
Polished Brass

Nickel Lucido
Nickel Plated

200 45 200 25 140

Nickel Satinato
Satin Nickel

Cromo Lucido
Chrome Plated

Cromo Satinato
Satin Chrome

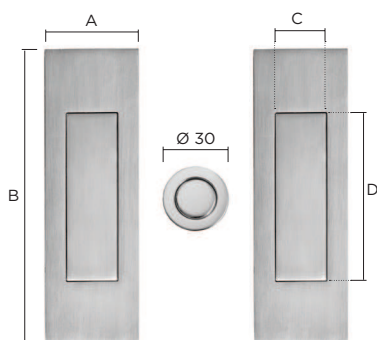

593 kit pull

Articolo
Item

Misure
Sizes

Finitura
Finish

A B C D

Maniglie incasso
Flush handles

Oro Lucido
Polished Brass

Nickel Lucido
Nickel Plated

140 45 140 25 80

Nickel Satinato
Satin Nickel

Cromo Lucido
Chrome Plated

Cromo Satinato
Satin Chrome

Oro Lucido
Polished Brass

Nickel Lucido
Nickel Plated

593 A

160 45 160 25 100

Nickel Satinato
Satin Nickel

Cromo Lucido
Chrome Plated

Cromo Satinato
Satin Chrome

Oro Lucido
Polished Brass

Nickel Lucido
Nickel Plated

200 45 200 25 140

Nickel Satinato
Satin Nickel

Cromo Lucido
Chrome Plated

Cromo Satinato
Satin Chrome

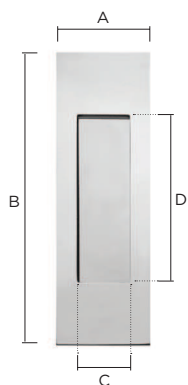

Articolo Item	Misure Sizes				Finitura Finish	
	A	B	C	D		
Maniglie incasso Flush handles	140	45	140	25	80	Oro Lucido Polished Brass
						Nickel Lucido Nickel Plated
						Nickel Satinato Satin Nickel
						Cromo Lucido Chrome Plated
						Cromo Satinato Satin Chrome
593 A FC	160	45	160	25	100	Oro Lucido Polished Brass
						Nickel Lucido Nickel Plated
						Nickel Satinato Satin Nickel
						Cromo Lucido Chrome Plated
						Cromo Satinato Satin Chrome
593 AC kit pull	160	45	162	24	80	Oro Lucido Polished Brass
						Nickel Lucido Nickel Plated
						Nickel Satinato Satin Nickel
						Cromo Lucido Chrome Plated
						Cromo Satinato Satin Chrome

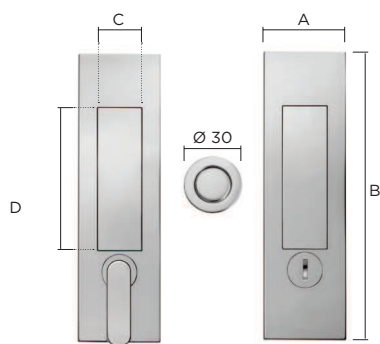
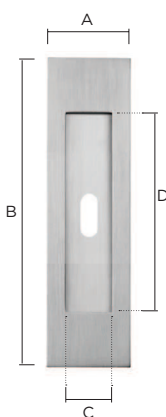

	Articolo Item	Misure Sizes				Finitura Finish
		A	B	C	D	
	Maniglie incasso magnetiche Magnetic flush handles 594 Ditale	30	30	19		Oro Lucido Polished Brass Nickel Lucido Nickel Plated Nickel Satinato Satin Nickel Cromo Lucido Chrome Plated Cromo Satinato Satin Chrome
	Maniglie incasso magnetiche Magnetic flush handles 594 A	60	60	34		Oro Lucido Polished Brass Nickel Lucido Nickel Plated Nickel Satinato Satin Nickel Cromo Lucido Chrome Plated Cromo Satinato Satin Chrome
	Maniglie incasso magnetiche Magnetic flush handles 594 A kit pull	60	60	30	34	Oro Lucido Polished Brass Nickel Lucido Nickel Plated Nickel Satinato Satin Nickel Cromo Lucido Chrome Plated Cromo Satinato Satin Chrome
	Maniglie incasso magnetiche Magnetic flush handles 594 B	60	60	34	60	Oro Lucido Polished Brass Nickel Lucido Nickel Plated Nickel Satinato Satin Nickel Cromo Lucido Chrome Plated Cromo Satinato Satin Chrome

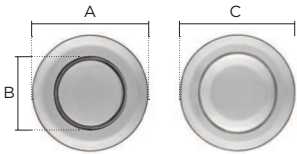
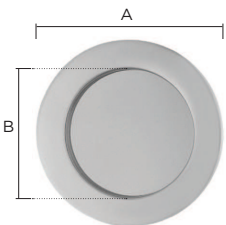
Articolo Item	Misure Sizes				Finitura Finish	
	A	B	C	D		
<p>Maniglie incasso magnetiche Magnetic flush handles</p>  <p>594 C</p>	60	60	34	40	Oro Lucido Polished Brass	
					Nickel Lucido Nickel Plated	
					Nickel Satinato Satin Nickel	
					Cromo Lucido Chrome Plated	
					Cromo Satinato Satin Chrome	
<p>Maniglie incasso Flush handles</p>  <p>595</p>	30	30	19		Oro Lucido Polished Brass	
					Bronzo Antico Antique Bronze	
					Nickel Lucido Nickel Plated	
					Nickel Satinato Satin Nickel	
	40	40	27			Cromo Lucido Chrome Plated
						Cromo Satinato Satin Chrome
						Oro Lucido Polished Brass
						Bronzo Antico Antique Bronze
	50	48	32			Nickel Lucido Nickel Plated
						Nickel Satinato Satin Nickel
						Cromo Lucido Chrome Plated
						Cromo Satinato Satin Chrome

Articolo
Item

Misure
Sizes

Finitura
Finish

A

B

C

D

Maniglie incasso
Flush handles

Oro Lucido
Polished Brass

Bronzo Antico
Antique Bronze

Nickel Lucido
Nickel Plated

Nickel Satinato
Satin Nickel

Cromo Lucido
Chrome Plated

Cromo Satinato
Satin Chrome

55 54 35

Oro Lucido
Polished Brass

Bronzo Antico
Antique Bronze

Nickel Lucido
Nickel Plated

Nickel Satinato
Satin Nickel

Cromo Lucido
Chrome Plated

Cromo Satinato
Satin Chrome

60 59 39

Oro Lucido
Polished Brass

Bronzo Antico
Antique Bronze

Nickel Lucido
Nickel Plated

Nickel Satinato
Satin Nickel

Cromo Lucido
Chrome Plated

Cromo Satinato
Satin Chrome

80 79 54

Oro Lucido
Polished Brass

Bronzo Antico
Antique Bronze

Nickel Lucido
Nickel Plated

Nickel Satinato
Satin Nickel

Cromo Lucido
Chrome Plated

Cromo Satinato
Satin Chrome

120 119 94

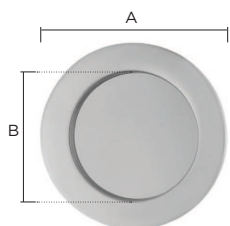

595

Maniglie incasso
Flush handles

30

29

29

15

15

Oro Lucido
Polished Brass

Bronzo Antico
Antique Bronze

Nickel Lucido
Nickel Plated

Nickel Satinato
Satin Nickel

Cromo Lucido
Chrome Plated

Cromo Satinato
Satin Chrome

40

40

40

21

21

Oro Lucido
Polished Brass

Bronzo Antico
Antique Bronze

Nickel Lucido
Nickel Plated

Nickel Satinato
Satin Nickel

Cromo Lucido
Chrome Plated

Cromo Satinato
Satin Chrome

596

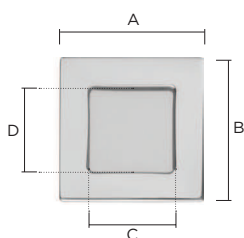

50

52

52

30

30

Oro Lucido
Polished Brass

Bronzo Antico
Antique Bronze

Nickel Lucido
Nickel Plated

Nickel Satinato
Satin Nickel

Cromo Lucido
Chrome Plated

Cromo Satinato
Satin Chrome

60

60

60

35

35

Oro Lucido
Polished Brass

Bronzo Antico
Antique Bronze

Nickel Lucido
Nickel Plated

Nickel Satinato
Satin Nickel

Cromo Lucido
Chrome Plated

Cromo Satinato
Satin Chrome

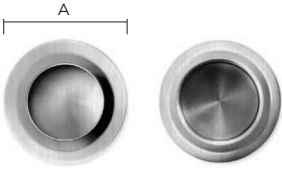
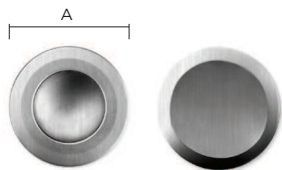
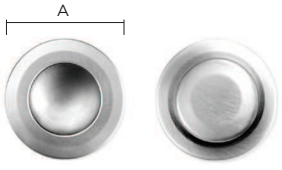
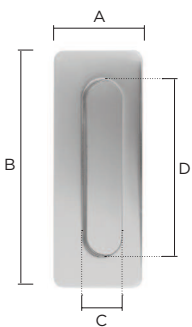
	Articolo Item	Misure Sizes				Finitura Finish	
		A	B	C	D		
	<p>Maniglie incasso Flush handles</p> <p>597 A</p>	60	60			<p>Oro Lucido Polished Brass</p> <hr/> <p>Nickel Satinato Satin Nickel</p> <hr/> <p>Cromo Lucido Chrome Plated</p> <hr/> <p>Cromo Satinato Satin Chrome</p>	
	<p>Maniglie incasso Flush handles</p> <p>597 B</p>	60	60			<p>Oro Lucido Polished Brass</p> <hr/> <p>Nickel Satinato Satin Nickel</p> <hr/> <p>Cromo Lucido Chrome Plated</p> <hr/> <p>Cromo Satinato Satin Chrome</p>	
	<p>Maniglie incasso Flush handles</p> <p>597 C</p>	60	60			<p>Oro Lucido Polished Brass</p> <hr/> <p>Nickel Satinato Satin Nickel</p> <hr/> <p>Cromo Lucido Chrome Plated</p> <hr/> <p>Cromo Satinato Satin Chrome</p>	
	<p>Maniglie incasso Flush handles</p> <p>598</p>	64	42	78	18	48	<p>Oro Lucido Polished Brass</p> <hr/> <p>Bronzo Antico Antique Bronze</p> <hr/> <p>Nickel Lucido Nickel Plated</p> <hr/> <p>Nickel Satinato Satin Nickel</p> <hr/> <p>Cromo Lucido Chrome Plated</p> <hr/> <p>Cromo Satinato Satin Chrome</p>

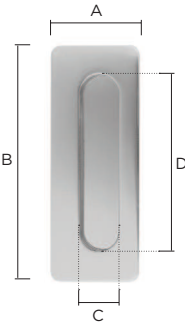
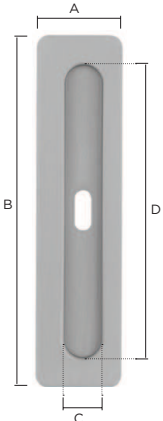

Articolo Item	Misure Sizes				Finitura Finish	
	A	B	C	D		
 <p>598</p>	96	42	110	18	48	Oro Lucido Polished Brass
						Bronzo Antico Antique Bronze
						Nickel Lucido Nickel Plated
						Nickel Satinato Satin Nickel
						Cromo Lucido Chrome Plated
						Cromo Satinato Satin Chrome
	128	42	142	18	112	Oro Lucido Polished Brass
						Bronzo Antico Antique Bronze
						Nickel Lucido Nickel Plated
						Nickel Satinato Satin Nickel
						Cromo Lucido Chrome Plated
						Cromo Satinato Satin Chrome
160	42	174	18	144	Oro Lucido Polished Brass	
					Bronzo Antico Antique Bronze	
					Nickel Lucido Nickel Plated	
					Nickel Satinato Satin Nickel	
					Cromo Lucido Chrome Plated	
					Cromo Satinato Satin Chrome	
 <p>598 FC</p>	128	42	142	18	112	Oro Lucido Polished Brass
						Bronzo Antico Antique Bronze
						Nickel Lucido Nickel Plated
						Nickel Satinato Satin Nickel
						Cromo Lucido Chrome Plated
						Cromo Satinato Satin Chrome

Articolo
Item

Misure
Sizes

Finitura
Finish

A B C D

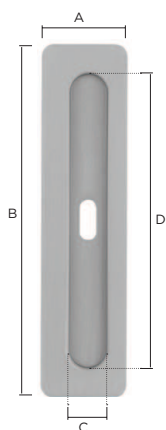

Maniglie incasso
Flush handles

598 FC

160 42 174 18 144

Oro Lucido
Polished Brass

Bronzo Antico
Antique Bronze

Nickel Lucido
Nickel Plated

Nickel Satinato
Satin Nickel

Cromo Lucido
Chrome Plated

Cromo Satinato
Satin Chrome

Maniglie incasso
Flush handles

64 37 76 18 48

Oro Lucido
Polished Brass

Bronzo Antico
Antique Bronze

Nickel Lucido
Nickel Plated

Nickel Satinato
Satin Nickel

Cromo Lucido
Chrome Plated

Cromo Satinato
Satin Chrome

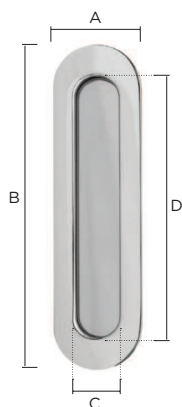

598 OV

96 37 109 18 80

Oro Lucido
Polished Brass

Bronzo Antico
Antique Bronze

Nickel Lucido
Nickel Plated

Nickel Satinato
Satin Nickel

Cromo Lucido
Chrome Plated

Cromo Satinato
Satin Chrome

128 37 141 18 112

Oro Lucido
Polished Brass

Bronzo Antico
Antique Bronze

Nickel Lucido
Nickel Plated

Nickel Satinato
Satin Nickel

Cromo Lucido
Chrome Plated

Cromo Satinato
Satin Chrome

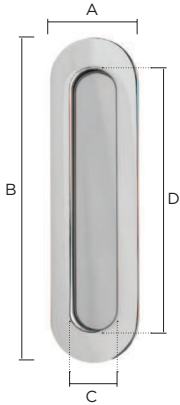

Articolo Item	Misure Sizes				Finitura Finish
	A	B	C	D	
 <p>Maniglie incasso Flush handles</p> <p>598 OV</p>	160	37	173	18	144
					Oro Lucido Polished Brass
					Bronzo Antico Antique Bronze
					Nickel Lucido Nickel Plated
					Nickel Satinato Satin Nickel
					Cromo Lucido Chrome Plated
Cromo Satinato Satin Chrome					

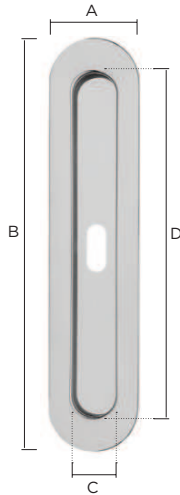
 <p>Maniglie incasso Flush handles</p> <p>598 OV FC</p>	128	37	141	18	112
					Oro Lucido Polished Brass
					Bronzo Antico Antique Bronze
					Nickel Lucido Nickel Plated
					Nickel Satinato Satin Nickel
					Cromo Lucido Chrome Plated
Cromo Satinato Satin Chrome					
	160	37	173	18	144
					Oro Lucido Polished Brass
					Bronzo Antico Antique Bronze
					Nickel Lucido Nickel Plated
					Nickel Satinato Satin Nickel
					Cromo Lucido Chrome Plated
Cromo Satinato Satin Chrome					

Articolo
Item

Misure
Sizes

Finitura
Finish

A

B

C

D

Maniglie per mobile
Cabinet handles

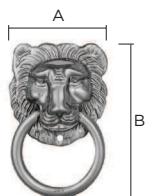

645

32 31 47

Oro Lucido
Polished Brass

Bronzo Antico Etrusco
Etruscan Antique Bronze

43 43 66

Oro Lucido
Polished Brass

Bronzo Antico Etrusco
Etruscan Antique Bronze

Maniglie per mobile
Cabinet handles

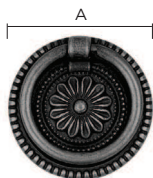

650

32 32

Oro Lucido
Polished Brass

Bronzo Antico Etrusco
Etruscan Antique Bronze

39 39

Oro Lucido
Polished Brass

Bronzo Antico Etrusco
Etruscan Antique Bronze

46 46

Oro Lucido
Polished Brass

Bronzo Antico Etrusco
Etruscan Antique Bronze

Catenelle mobile
Cabinet chains

Oro Lucido
Polished Brass

150 150 35 11

Bronzo Antico Etrusco
Etruscan Antique Bronze

Nickel Lucido
Nickel Plated

Oro Lucido
Polished Brass

200 200 35 11

Bronzo Antico Etrusco
Etruscan Antique Bronze

Nickel Lucido
Nickel Plated

Oro Lucido
Polished Brass

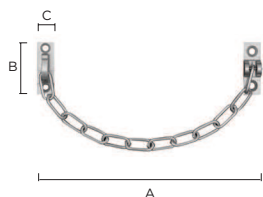

760 CG

250 250 35 11

Bronzo Antico Etrusco
Etruscan Antique Bronze

Nickel Lucido
Nickel Plated

Oro Lucido
Polished Brass

300 300 35 11

Bronzo Antico Etrusco
Etruscan Antique Bronze

Nickel Lucido
Nickel Plated

Oro Lucido
Polished Brass

350 350 35 11

Bronzo Antico Etrusco
Etruscan Antique Bronze

Nickel Lucido
Nickel Plated

Articolo
Item

Misure
Sizes

Finitura
Finish

A

B

C

D

Catenelle mobile
Cabinet chains

Oro Lucido
Polished Brass

400 400 35 11

Bronzo Antico Etrusco
Etruscan Antique Bronze

Nickel Lucido
Nickel Plated

760 CG

Oro Lucido
Polished Brass

500 500 35 11

Bronzo Antico Etrusco
Etruscan Antique Bronze

Nickel Lucido
Nickel Plated

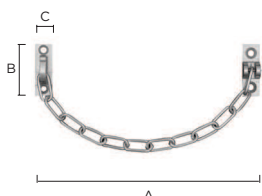

Catenelle mobile
Cabinet chains

Oro Lucido
Polished Brass

150 150 35 11

Bronzo Antico Etrusco
Etruscan Antique Bronze

Nickel Lucido
Nickel Plated

760 FS

Oro Lucido
Polished Brass

200 200 35 11

Bronzo Antico Etrusco
Etruscan Antique Bronze

Nickel Lucido
Nickel Plated

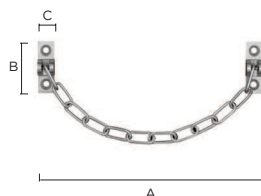

Catenelle mobile
Cabinet chains

250

250

35

11

Oro Lucido
Polished Brass

Bronzo Antico Etrusco
Etruscan Antique Bronze

Nickel Lucido
Nickel Plated

300

300

35

11

Oro Lucido
Polished Brass

Bronzo Antico Etrusco
Etruscan Antique Bronze

Nickel Lucido
Nickel Plated

350

350

35

11

Oro Lucido
Polished Brass

Bronzo Antico Etrusco
Etruscan Antique Bronze

Nickel Lucido
Nickel Plated

400

400

35

11

Oro Lucido
Polished Brass

Bronzo Antico Etrusco
Etruscan Antique Bronze

Nickel Lucido
Nickel Plated

500

500

35

11

Oro Lucido
Polished Brass

Bronzo Antico Etrusco
Etruscan Antique Bronze

Nickel Lucido
Nickel Plated

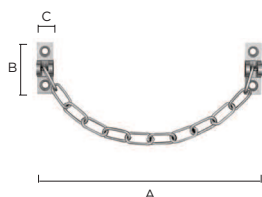

760 FS

Catene mobile
Cabinet chains

Oro Lucido
Polished Brass

150

150

25

8

Bronzo Antico Etrusco
Etruscan Antique Bronze

Nickel Lucido
Nickel Plated

Oro Lucido
Polished Brass

200

200

25

8

Bronzo Antico Etrusco
Etruscan Antique Bronze

Nickel Lucido
Nickel Plated

Oro Lucido
Polished Brass

761

250

250

25

8

Bronzo Antico Etrusco
Etruscan Antique Bronze

Nickel Lucido
Nickel Plated

Oro Lucido
Polished Brass

300

300

25

8

Bronzo Antico Etrusco
Etruscan Antique Bronze

Nickel Lucido
Nickel Plated

Oro Lucido
Polished Brass

350

350

25

8

Bronzo Antico Etrusco
Etruscan Antique Bronze

Nickel Lucido
Nickel Plated

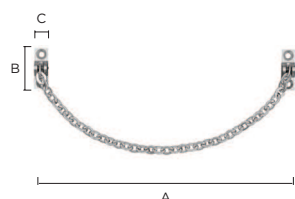

Catenelle mobile
Cabinet chains

Oro Lucido
Polished Brass

Bronzo Antico Etrusco
Etruscan Antique Bronze

Nickel Lucido
Nickel Plated

Oro Lucido
Polished Brass

Bronzo Antico Etrusco
Etruscan Antique Bronze

Nickel Lucido
Nickel Plated

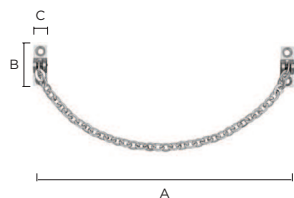

761

400 400 25 8

500 500 25 8

Supporti tenda
Curtains brackets

Oro Lucido
Polished Brass

25 Bronzo Antico
Antique Bronze

Cromo Lucido
Chrome Plated

Oro Lucido
Polished Brass

25 Bronzo Antico
Antique Bronze

Cromo Lucido
Chrome Plated

Oro Lucido
Polished Brass

30 Bronzo Antico
Antique Bronze

Cromo Lucido
Chrome Plated

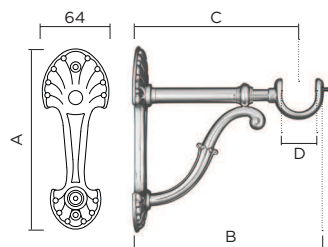

800

25x140 173

25x200 173

30x140 173

Articolo
Item

Misure
Sizes

Finitura
Finish

A

B

C

D

Supporti tenda
Curtains brackets

30x200

173

30

Oro Lucido
Polished Brass

Bronzo Antico
Antique Bronze

Cromo Lucido
Chrome Plated

35x140

173

35

Oro Lucido
Polished Brass

Bronzo Antico
Antique Bronze

Cromo Lucido
Chrome Plated

35x200

173

35

Oro Lucido
Polished Brass

Bronzo Antico
Antique Bronze

Cromo Lucido
Chrome Plated

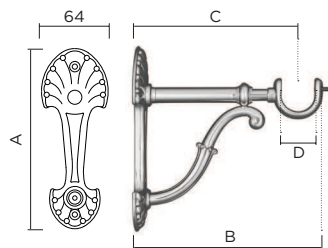

800

Supporti tenda
Curtains brackets

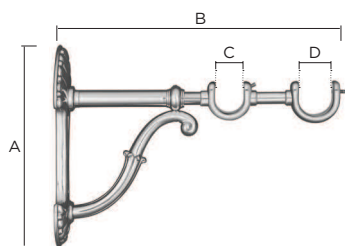

800 D

173

25

30

Oro Lucido
Polished Brass

Bronzo Antico
Antique Bronze

Cromo Lucido
Chrome Plated

Supporti tenda
Curtains brackets

Oro Lucido
Polished Brass

25x120 58 84 151 25 Bronzo Antico
Antique Bronze

Cromo Lucido
Chrome Plated

Oro Lucido
Polished Brass

25x180 58 84 211 25 Bronzo Antico
Antique Bronze

Cromo Lucido
Chrome Plated

Oro Lucido
Polished Brass

25x240 58 84 267 25 Bronzo Antico
Antique Bronze

Cromo Lucido
Chrome Plated

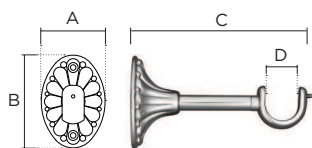

801

Oro Lucido
Polished Brass

30x120 58 84 157 30 Bronzo Antico
Antique Bronze

Cromo Lucido
Chrome Plated

Oro Lucido
Polished Brass

30x180 58 84 217 30 Bronzo Antico
Antique Bronze

Cromo Lucido
Chrome Plated

Oro Lucido
Polished Brass

30x240 58 84 273 30 Bronzo Antico
Antique Bronze

Cromo Lucido
Chrome Plated

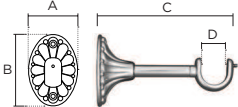
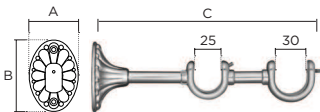
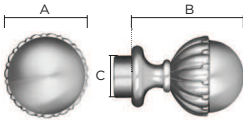
	Articolo Item	Misure Sizes				Finitura Finish	
		A	B	C	D		
	Supporti tenda Curtains brackets	35x120	58	84	163	35	Oro Lucido Polished Brass
							Bronzo Antico Antique Bronze
							Cromo Lucido Chrome Plated
	801	35x180	58	84	223	35	Oro Lucido Polished Brass
							Bronzo Antico Antique Bronze
							Cromo Lucido Chrome Plated
	35x240	58	84	279	35	Oro Lucido Polished Brass	
						Bronzo Antico Antique Bronze	
						Cromo Lucido Chrome Plated	
	Supporti tenda Curtains brackets	58	84	348	35	Oro Lucido Polished Brass	
						Bronzo Antico Antique Bronze	
						Cromo Lucido Chrome Plated	
	Finali End-knobs	25	44	63	25	Oro Lucido Polished Brass	
						Bronzo Antico Antique Bronze	
						Cromo Lucido Chrome Plated	
	802	30	53	75	30	Oro Lucido Polished Brass	
						Bronzo Antico Antique Bronze	
						Cromo Lucido Chrome Plated	

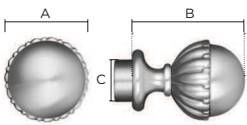
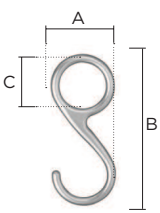
	Articolo Item	Misure Sizes				Finitura Finish	
		A	B	C	D		
	Finali End-knobs					Oro Lucido Polished Brass	
	802	35	62	86	35	Bronzo Antico Antique Bronze	
						Cromo Lucido Chrome Plated	
	Sistema Reling Reling System					Oro Lucido Polished Brass	
						Bronzo Antico Antique Bronze	
		13	19	45	13	Nickel Satinato Satin Nickel	
						Cromo Lucido Chrome Plated	
						Cromo Satinato Satin Chrome	
						Oro Lucido Polished Brass	
						Bronzo Antico Antique Bronze	
		803	18	26	62	18	Nickel Satinato Satin Nickel
						Cromo Lucido Chrome Plated	
						Cromo Satinato Satin Chrome	
						Oro Lucido Polished Brass	
						Bronzo Antico Antique Bronze	
		20	28	69	20	Nickel Satinato Satin Nickel	
					Cromo Lucido Chrome Plated		
					Cromo Satinato Satin Chrome		

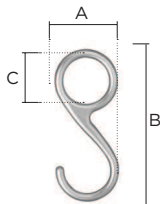
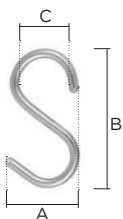
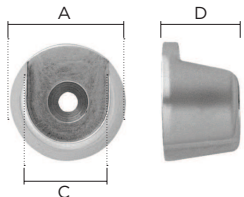
	Articolo Item	Misure Sizes				Finitura Finish	
		A	B	C	D		
	Sistema Reling Reling System	803	25	35	85	25	Oro Lucido Polished Brass
	Bronzo Antico Antique Bronze						
	Nickel Satinato Satin Nickel						
	Cromo Lucido Chrome Plated						
	Cromo Satinato Satin Chrome						
	Sistema Reling Reling System	803 E		31	41	18	Oro Lucido Polished Brass
	Bronzo Antico Antique Bronze						
	Nickel Satinato Satin Nickel						
	Cromo Lucido Chrome Plated						
	Cromo Satinato Satin Chrome						
	Reggitubo Bracket	11	20	12	13	Oro Lucido Polished Brass	
	Cromo Lucido Chrome Plated						
	Cromo Satinato Satin Chrome						
	13	23	14	15	Oro Lucido Polished Brass		
					Cromo Lucido Chrome Plated		
	Cromo Satinato Satin Chrome						
	16	25	17	16	Oro Lucido Polished Brass		
					Cromo Lucido Chrome Plated		
	Cromo Satinato Satin Chrome						

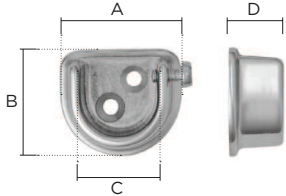
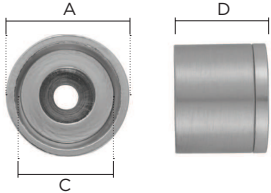
Articolo Item	Misure Sizes				Finitura Finish	
	A	B	C	D		
 <p>841</p> <p>Left/Right</p>	20	37	32	21	17	Oro Lucido Polished Brass
						Cromo Lucido Chrome Plated
						Cromo Satinato Satin Chrome
	25	42	37	26	18	Oro Lucido Polished Brass
						Cromo Lucido Chrome Plated
						Cromo Satinato Satin Chrome
 <p>842</p>	11	15		11	20	Oro Lucido Polished Brass
						Nickel Satinato Satin Nickel
						Cromo Lucido Chrome Plated
						Cromo Satinato Satin Chrome
	13	17		13	20	Oro Lucido Polished Brass
						Nickel Satinato Satin Nickel
						Cromo Lucido Chrome Plated
						Cromo Satinato Satin Chrome
	16	20		16	20	Oro Lucido Polished Brass
						Nickel Satinato Satin Nickel
						Cromo Lucido Chrome Plated
						Cromo Satinato Satin Chrome
20	24		20	20	Oro Lucido Polished Brass	
					Nickel Satinato Satin Nickel	
					Cromo Lucido Chrome Plated	
					Cromo Satinato Satin Chrome	

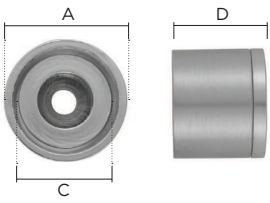
Articolo Item	Misure Sizes				Finitura Finish
	A	B	C	D	
842 	25	29	25	20	Oro Lucido Polished Brass
					Nickel Satinato Satin Nickel
					Cromo Lucido Chrome Plated
					Cromo Satinato Satin Chrome
	30	35	30	20	Oro Lucido Polished Brass
					Nickel Satinato Satin Nickel
					Cromo Lucido Chrome Plated
					Cromo Satinato Satin Chrome

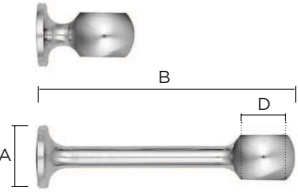
844 	11x20	20	30	11	Oro Lucido Polished Brass
					Bronzo Antico Antique Bronze
					Nickel Satinato Satin Nickel
					Cromo Lucido Chrome Plated
	11x40	20	50	11	Cromo Satinato Satin Chrome
					Oro Lucido Polished Brass
					Bronzo Antico Antique Bronze
					Nickel Satinato Satin Nickel
11x40	20	50	11	Cromo Lucido Chrome Plated	
				Cromo Satinato Satin Chrome	

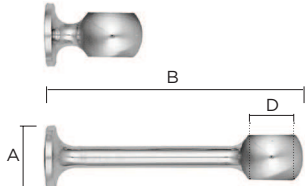
Articolo Item	Misure Sizes				Finitura Finish	
	A	B	C	D		
 <p>844</p>					Oro Lucido Polished Brass	
						Bronzo Antico Antique Bronze
	11x70	20	80	11	Nickel Satinato Satin Nickel	
					Cromo Lucido Chrome Plated	
					Cromo Satinato Satin Chrome	
					Oro Lucido Polished Brass	
					Bronzo Antico Antique Bronze	
	13x20	20	30	13	Nickel Satinato Satin Nickel	
					Cromo Lucido Chrome Plated	
					Cromo Satinato Satin Chrome	
					Oro Lucido Polished Brass	
					Bronzo Antico Antique Bronze	
	13x40	20	50	13	Nickel Satinato Satin Nickel	
					Cromo Lucido Chrome Plated	
					Cromo Satinato Satin Chrome	
					Oro Lucido Polished Brass	
				Bronzo Antico Antique Bronze		
13x70	20	80	13	Nickel Satinato Satin Nickel		
				Cromo Lucido Chrome Plated		
				Cromo Satinato Satin Chrome		

Reggitubo
Bracket

20x70

60

94

20

Oro Lucido
Polished Brass

Bronzo Antico
Antique Bronze

Nickel Satinato
Satin Nickel

Cromo Lucido
Chrome Plated

20x120

60

144

20

Oro Lucido
Polished Brass

Bronzo Antico
Antique Bronze

Nickel Satinato
Satin Nickel

Cromo Lucido
Chrome Plated

20x180

60

204

20

Oro Lucido
Polished Brass

Bronzo Antico
Antique Bronze

Nickel Satinato
Satin Nickel

Cromo Lucido
Chrome Plated

25x70

60

99

25

Oro Lucido
Polished Brass

Bronzo Antico
Antique Bronze

Nickel Satinato
Satin Nickel

Cromo Lucido
Chrome Plated

25x120

60

149

25

Oro Lucido
Polished Brass

Bronzo Antico
Antique Bronze

Nickel Satinato
Satin Nickel

Cromo Lucido
Chrome Plated

25x180

60

209

25

Oro Lucido
Polished Brass

Bronzo Antico
Antique Bronze

Nickel Satinato
Satin Nickel

Cromo Lucido
Chrome Plated

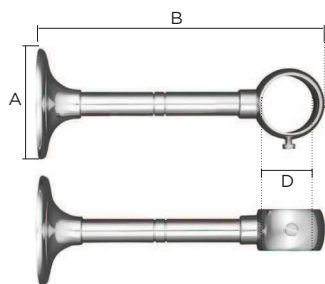

845

Articolo
Item

Misure
Sizes

A B C D

Finitura
Finish

Reggitubo
Bracket

30x70

60

104

30

Oro Lucido
Polished Brass

Bronzo Antico
Antique Bronze

Nickel Satinato
Satin Nickel

Cromo Lucido
Chrome Plated

30x120

60

154

30

Oro Lucido
Polished Brass

Bronzo Antico
Antique Bronze

Nickel Satinato
Satin Nickel

Cromo Lucido
Chrome Plated

30x180

60

214

30

Oro Lucido
Polished Brass

Bronzo Antico
Antique Bronze

Nickel Satinato
Satin Nickel

Cromo Lucido
Chrome Plated

35x70

60

109

35

Oro Lucido
Polished Brass

Bronzo Antico
Antique Bronze

Nickel Satinato
Satin Nickel

Cromo Lucido
Chrome Plated

35x120

60

159

35

Oro Lucido
Polished Brass

Bronzo Antico
Antique Bronze

Nickel Satinato
Satin Nickel

Cromo Lucido
Chrome Plated

35x180

60

219

35

Oro Lucido
Polished Brass

Bronzo Antico
Antique Bronze

Nickel Satinato
Satin Nickel

Cromo Lucido
Chrome Plated

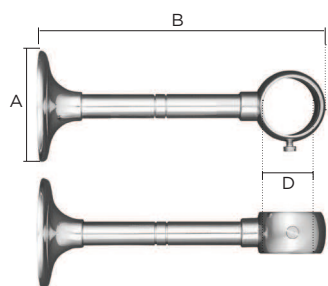

845

Reggitubo
Bracket

25x70

60

104

25

Oro Lucido
Polished Brass

Bronzo Antico
Antique Bronze

Nickel Satinato
Satin Nickel

Cromo Lucido
Chrome Plated

25x120

60

154

25

Oro Lucido
Polished Brass

Bronzo Antico
Antique Bronze

Nickel Satinato
Satin Nickel

Cromo Lucido
Chrome Plated

25x180

60

214

25

Oro Lucido
Polished Brass

Bronzo Antico
Antique Bronze

Nickel Satinato
Satin Nickel

Cromo Lucido
Chrome Plated

845 A

30x70

60

110

30

Oro Lucido
Polished Brass

Bronzo Antico
Antique Bronze

Nickel Satinato
Satin Nickel

Cromo Lucido
Chrome Plated

30x120

60

160

30

Oro Lucido
Polished Brass

Bronzo Antico
Antique Bronze

Nickel Satinato
Satin Nickel

Cromo Lucido
Chrome Plated

30x180

60

220

30

Oro Lucido
Polished Brass

Bronzo Antico
Antique Bronze

Nickel Satinato
Satin Nickel

Cromo Lucido
Chrome Plated

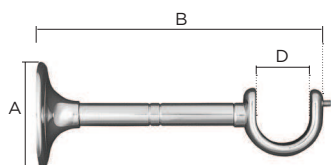

Articolo
Item

Misure
Sizes

A B C D

Finitura
Finish

Reggitubo
Bracket

Oro Lucido
Polished Brass

Bronzo Antico
Antique Bronze

35x70 60 115

35

Nickel Satinato
Satin Nickel

Cromo Lucido
Chrome Plated

Oro Lucido
Polished Brass

Bronzo Antico
Antique Bronze

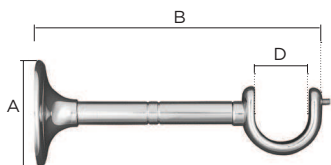

845 A

35x120 60 165

35

Nickel Satinato
Satin Nickel

Cromo Lucido
Chrome Plated

Oro Lucido
Polished Brass

Bronzo Antico
Antique Bronze

35x180 60 225

35

Nickel Satinato
Satin Nickel

Cromo Lucido
Chrome Plated

Articolo
Item

Misure
Sizes

Finitura
Finish

A B C D

Accessori scala
Stairs accessories

62 620 30

Oro Lucido
Polished Brass

Cromo Lucido
Chrome Plated

82 820 30

Oro Lucido
Polished Brass

Cromo Lucido
Chrome Plated

102 1020 30

Oro Lucido
Polished Brass

Cromo Lucido
Chrome Plated

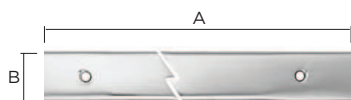

849

Accessori scala
Stairs accessories

9 9 9

Oro Lucido
Polished Brass

Cromo Lucido
Chrome Plated

11 11 12

Oro Lucido
Polished Brass

Cromo Lucido
Chrome Plated

13 13 13

Oro Lucido
Polished Brass

Cromo Lucido
Chrome Plated

16 16 15

Oro Lucido
Polished Brass

Cromo Lucido
Chrome Plated

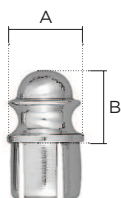

850

Accessori scala
Stairs accessories

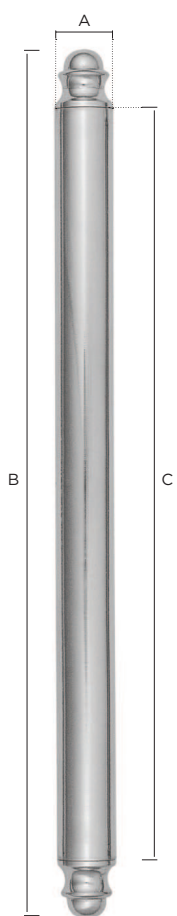

851

Articolo Item	Misure Sizes				Finitura Finish
	A	B	C	D	
9	9	700	681	Oro Lucido Polished Brass	
				Cromo Lucido Chrome Plated	
9	9	800	781	Oro Lucido Polished Brass	
				Cromo Lucido Chrome Plated	
9	9	900	881	Oro Lucido Polished Brass	
				Cromo Lucido Chrome Plated	
9	9	1000	981	Oro Lucido Polished Brass	
				Cromo Lucido Chrome Plated	
11	11	700	676	Oro Lucido Polished Brass	
				Cromo Lucido Chrome Plated	
11	11	800	776	Oro Lucido Polished Brass	
				Cromo Lucido Chrome Plated	
11	11	900	876	Oro Lucido Polished Brass	
				Cromo Lucido Chrome Plated	
11	11	1000	976	Oro Lucido Polished Brass	
				Cromo Lucido Chrome Plated	
13	13	700	673	Oro Lucido Polished Brass	
				Cromo Lucido Chrome Plated	
13	13	800	773	Oro Lucido Polished Brass	
				Cromo Lucido Chrome Plated	

Accessori scala
Stairs accessories

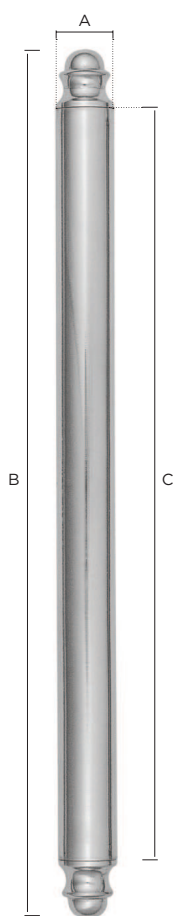

851

Articolo Item	Misure Sizes				Finitura Finish
	A	B	C	D	
13	13	900	873	Oro Lucido Polished Brass	
				Cromo Lucido Chrome Plated	
13	13	1000	973	Oro Lucido Polished Brass	
				Cromo Lucido Chrome Plated	
13	13	1100	1073	Oro Lucido Polished Brass	
				Cromo Lucido Chrome Plated	
13	13	1000	973	Oro Lucido Polished Brass	
				Cromo Lucido Chrome Plated	
13	13	1100	1073	Oro Lucido Polished Brass	
				Cromo Lucido Chrome Plated	
16	16	900	870	Oro Lucido Polished Brass	
				Cromo Lucido Chrome Plated	
16	16	1000	970	Oro Lucido Polished Brass	
				Cromo Lucido Chrome Plated	
16	16	1100	1070	Oro Lucido Polished Brass	
				Cromo Lucido Chrome Plated	
16	16	1200	1170	Oro Lucido Polished Brass	
				Cromo Lucido Chrome Plated	

Accessori scala
Stairs accessories

9

9 1500

Oro Lucido
Polished Brass

Cromo Lucido
Chrome Plated

9

9 2000

Oro Lucido
Polished Brass

Cromo Lucido
Chrome Plated

9

9 2500

Oro Lucido
Polished Brass

Cromo Lucido
Chrome Plated

9

9 3000

Oro Lucido
Polished Brass

Cromo Lucido
Chrome Plated

852

9

9 5000

Oro Lucido
Polished Brass

Oro Lucido
Polished Brass

Bronzo Antico
Antique Bronze

11

11 1500

Nickel Satinato
Satin Nickel

Cromo Lucido
Chrome Plated

Cromo Satinato
Satin Chrome

11

11 2000

Oro Lucido
Polished Brass

Bronzo Antico
Antique Bronze

Nickel Satinato
Satin Nickel

Cromo Lucido
Chrome Plated

Cromo Satinato
Satin Chrome

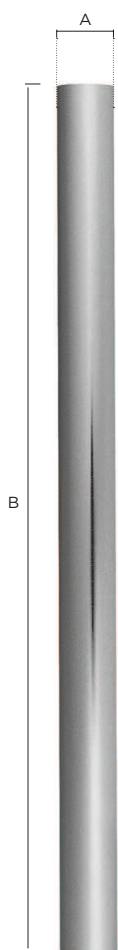

Articolo
Item

Misure
Sizes

Finitura
Finish

A

B

C

D

Accessori scala
Stairs accessories

Oro Lucido
Polished Brass

Nickel Satinato
Satin Nickel

11 11 2500

Cromo Lucido
Chrome Plated

Cromo Satinato
Satin Chrome

Oro Lucido
Polished Brass

Nickel Satinato
Satin Nickel

11 11 3000

Cromo Lucido
Chrome Plated

Cromo Satinato
Satin Chrome

852

11 11 5000

Oro Lucido
Polished Brass

Oro Lucido
Polished Brass

Bronzo Antico
Antique Bronze

13 13 1500

Nickel Satinato
Satin Nickel

Cromo Lucido
Chrome Plated

Cromo Satinato
Satin Chrome

Oro Lucido
Polished Brass

Bronzo Antico
Antique Bronze

13 13 2000

Nickel Satinato
Satin Nickel

Cromo Lucido
Chrome Plated

Cromo Satinato
Satin Chrome

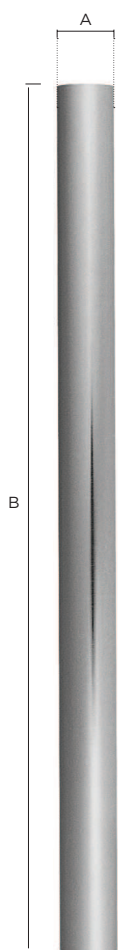

Accessori scala
Stairs accessories

Oro Lucido
Polished Brass

Nickel Satinato
Satin Nickel

13 13 2500

Cromo Lucido
Chrome Plated

Cromo Satinato
Satin Chrome

Oro Lucido
Polished Brass

Nickel Satinato
Satin Nickel

13 13 3000

Cromo Lucido
Chrome Plated

Cromo Satinato
Satin Chrome

13 13 5000

Oro Lucido
Polished Brass

852

16 16 1500

Oro Lucido
Polished Brass

16 16 2000

Oro Lucido
Polished Brass

Cromo Satinato
Satin Chrome

16 16 2500

Oro Lucido
Polished Brass

16 16 3000

Oro Lucido
Polished Brass

Cromo Satinato
Satin Chrome

16 16 5000

Oro Lucido
Polished Brass

20 20 1500

Oro Lucido
Polished Brass

Nickel Satinato
Satin Nickel

20 20 1500

Oro Lucido
Polished Brass

Nickel Satinato
Satin Nickel

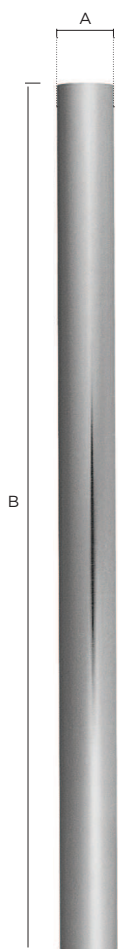

Articolo
Item

Misure
Sizes

Finitura
Finish

A

B

C

D

Accessori scala
Stairs accessories

Oro Lucido
Polished Brass

20 20 2000

Cromo Lucido
Chrome Plated

Cromo Satinato
Satin Chrome

Oro Lucido
Polished Brass

20 20 2500

Nickel Satinato
Satin Nickel

Cromo Lucido
Chrome Plated

Cromo Satinato
Satin Chrome

Oro Lucido
Polished Brass

852

Bronzo Antico
Antique Bronze

20 20 3000

Nickel Satinato
Satin Nickel

Cromo Lucido
Chrome Plated

Cromo Satinato
Satin Chrome

20 20 5000

Oro Lucido
Polished Brass

25 25 1500

Oro Lucido
Polished Brass

Oro Lucido
Polished Brass

Bronzo Antico
Antique Bronze

25 25 2000

Nickel Satinato
Satin Nickel

Cromo Lucido
Chrome Plated

Cromo Satinato
Satin Chrome

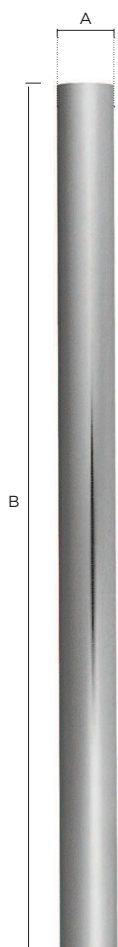

Accessori scala
Stairs accessories

Oro Lucido
Polished Brass

Bronzo Antico
Antique Bronze

25 25 2500

Nickel Satinato
Satin Nickel

Cromo Lucido
Chrome Plated

Cromo Satinato
Satin Chrome

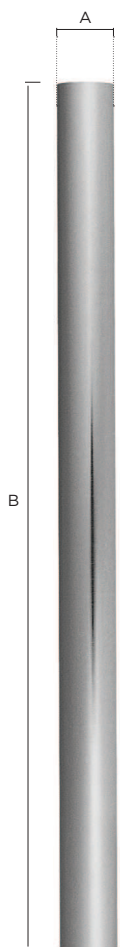

852

25 25 3000

Oro Lucido
Polished Brass

Bronzo Antico
Antique Bronze

Nickel Satinato
Satin Nickel

Cromo Lucido
Chrome Plated

Cromo Satinato
Satin Chrome

25 25 5000

Oro Lucido
Polished Brass

30 30 1500

Oro Lucido
Polished Brass

Oro Lucido
Polished Brass

Bronzo Antico
Antique Bronze

30 30 2000

Nickel Satinato
Satin Nickel

Cromo Lucido
Chrome Plated

Cromo Satinato
Satin Chrome

Accessori scala
Stairs accessories

Oro Lucido
Polished Brass

Bronzo Antico
Antique Bronze

30 30 2500

Nickel Satinato
Satin Nickel

Cromo Lucido
Chrome Plated

Cromo Satinato
Satin Chrome

Oro Lucido
Polished Brass

Bronzo Antico
Antique Bronze

30 30 3000

Nickel Satinato
Satin Nickel

Cromo Lucido
Chrome Plated

Cromo Satinato
Satin Chrome

30 30 5000

Oro Lucido
Polished Brass

35 35 1500

Oro Lucido
Polished Brass

Oro Lucido
Polished Brass

Nickel Satinato
Satin Nickel

35 35 2000

Cromo Lucido
Chrome Plated

Cromo Satinato
Satin Chrome

Oro Lucido
Polished Brass

35 35 2500

Cromo Lucido
Chrome Plated

Cromo Satinato
Satin Chrome

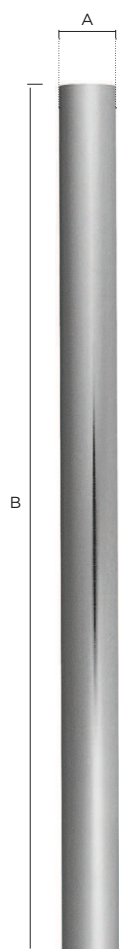

852

Accessori scala
Stairs accessories

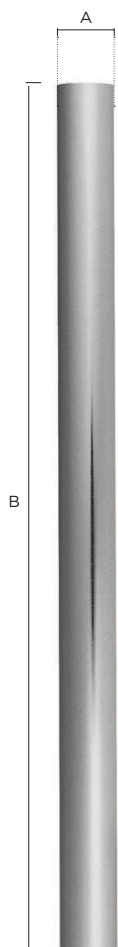

852

35

35

3000

Oro Lucido
Polished Brass

Bronzo Antico
Antique Bronze

Nickel Satinato
Satin Nickel

Cromo Lucido
Chrome Plated

Cromo Satinato
Satin Chrome

35

35

5000

Oro Lucido
Polished Brass

40

40

1500

Oro Lucido
Polished Brass

40

40

2000

Oro Lucido
Polished Brass

40

40

2500

Oro Lucido
Polished Brass

40

40

3000

Oro Lucido
Polished Brass

Bronzo Antico
Antique Bronze

40

40

5000

Oro Lucido
Polished Brass

Accessori scala
Stairs accessories

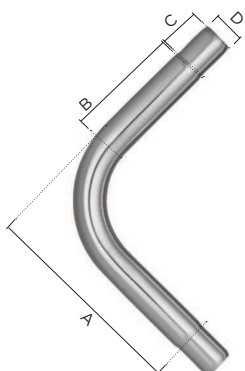

852 C 90°

11

105

55

20

9

Oro Lucido
Polished Brass

Bronzo Antico
Antique Bronze

Nickel Satinato
Satin Nickel

Cromo Lucido
Chrome Plated

Cromo Satinato
Satin Chrome

Accessori scala
Stairs accessories

Oro Lucido
Polished Brass

Bronzo Antico
Antique Bronze

13 116 65 20 11

Nickel Satinato
Satin Nickel

Cromo Lucido
Chrome Plated

Cromo Satinato
Satin Chrome

Oro Lucido
Polished Brass

Bronzo Antico
Antique Bronze

20 159 94 30 18

Nickel Satinato
Satin Nickel

Cromo Lucido
Chrome Plated

Cromo Satinato
Satin Chrome

852 C 90°

Oro Lucido
Polished Brass

Bronzo Antico
Antique Bronze

25 168 93 30 23

Nickel Satinato
Satin Nickel

Cromo Lucido
Chrome Plated

Cromo Satinato
Satin Chrome

Oro Lucido
Polished Brass

Bronzo Antico
Antique Bronze

30 179 89 35 28

Nickel Satinato
Satin Nickel

Cromo Lucido
Chrome Plated

Cromo Satinato
Satin Chrome

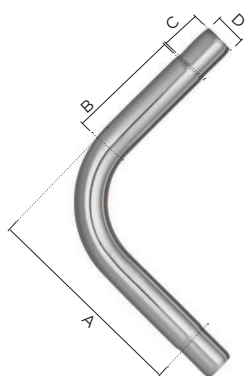

Accessori scala
Stairs accessories

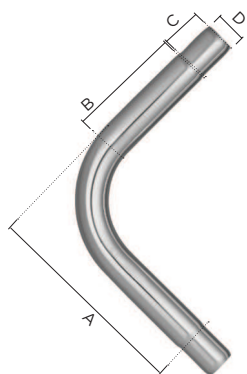

852 C 90°

35 190 91 35 33

Oro Lucido
Polished Brass

Bronzo Antico
Antique Bronze

Nickel Satinato
Satin Nickel

Cromo Lucido
Chrome Plated

Cromo Satinato
Satin Chrome

40 253 146 35 38

Oro Lucido
Polished Brass

Bronzo Antico
Antique Bronze

Nickel Satinato
Satin Nickel

Cromo Lucido
Chrome Plated

Cromo Satinato
Satin Chrome

Raccordo a Scomparsa
Hidden Joint

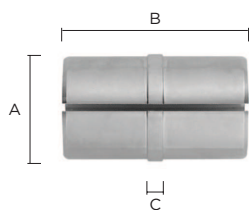

852 GI

25 25 60 5

30 30 60 5

35 35 60 5

40 40 60 5

Nickel Satinato
Satin Nickel

Accessori scala
Stairs accessories

25

25 2000

Oro Lucido
Polished Brass

Bronzo Antico
Antique Bronze

25

25 3000

Oro Lucido
Polished Brass

Bronzo Antico
Antique Bronze

25

25 5000

Oro Lucido
Polished Brass



30

30 2000

Oro Lucido
Polished Brass

Bronzo Antico
Antique Bronze

852 R

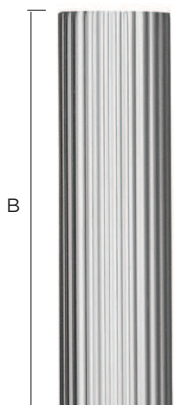

30

30 3000

Oro Lucido
Polished Brass

Bronzo Antico
Antique Bronze

30

30 5000

Oro Lucido
Polished Brass

35

35 2000

Oro Lucido
Polished Brass

Bronzo Antico
Antique Bronze

35

35 3000

Oro Lucido
Polished Brass

Bronzo Antico
Antique Bronze

35

35 5000

Oro Lucido
Polished Brass

Accessori scala
Stairs accessories



853

20 29 62 20 24

Oro Lucido
Polished Brass

Cromo Lucido
Chrome Plated

Cromo Satinato
Satin Chrome

25 40 90 25 29

Oro Lucido
Polished Brass

Cromo Lucido
Chrome Plated

Cromo Satinato
Satin Chrome

30 40 89 30 34

Oro Lucido
Polished Brass

Cromo Lucido
Chrome Plated

Cromo Satinato
Satin Chrome

Finali
End-knobs

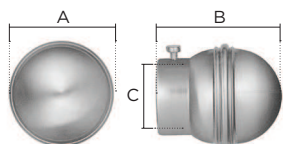

854

20 32 43 20

Oro Lucido
Polished Brass

Bronzo Antico
Antique Bronze

Nickel Satinato
Satin Nickel

Cromo Lucido
Chrome Plated

Cromo Satinato
Satin Chrome

25 42 49 25

Oro Lucido
Polished Brass

Bronzo Antico
Antique Bronze

Nickel Satinato
Satin Nickel

Cromo Lucido
Chrome Plated

Cromo Satinato
Satin Chrome

Articolo
Item

Misure
Sizes

Finitura
Finish

A B C D

Finili
End-knobs

Oro Lucido
Polished Brass

Bronzo Antico
Antique Bronze

30 49 58 30

Nickel Satinato
Satin Nickel

Cromo Lucido
Chrome Plated

Cromo Satinato
Satin Chrome

Oro Lucido
Polished Brass

Bronzo Antico
Antique Bronze

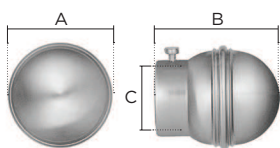

854

35 54 60 35

Nickel Satinato
Satin Nickel

Cromo Lucido
Chrome Plated

Cromo Satinato
Satin Chrome

Oro Lucido
Polished Brass

Bronzo Antico
Antique Bronze

40 56 65 40

Nickel Satinato
Satin Nickel

Cromo Lucido
Chrome Plated

Cromo Satinato
Satin Chrome

Supporti per tende
e scale
Curtains and stairs
brackets

20 44 71 50 21

Oro Lucido
Polished Brass

Bronzo Antico
Antique Bronze

Cromo Lucido
Chrome Plated

Cromo Satinato
Satin Chrome

25 54 86 60 26

Oro Lucido
Polished Brass

Bronzo Antico
Antique Bronze

Cromo Lucido
Chrome Plated

Cromo Satinato
Satin Chrome

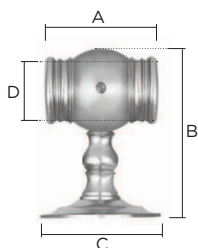

855

30 63 94 69 31

Oro Lucido
Polished Brass

Bronzo Antico
Antique Bronze

Cromo Lucido
Chrome Plated

Cromo Satinato
Satin Chrome

35 63 110 69 36

Oro Lucido
Polished Brass

Bronzo Antico
Antique Bronze

Cromo Lucido
Chrome Plated

Cromo Satinato
Satin Chrome

Articolo
Item

Misure
Sizes

Finitura
Finish

A B C D

Supporti per tende
e scale
Curtains and stairs
brackets

Oro Lucido
Polished Brass

Bronzo Antico
Antique Bronze

25 38 86 60 26

Nickel Satinato
Satin Nickel

Cromo Lucido
Chrome Plated

Cromo Satinato
Satin Chrome

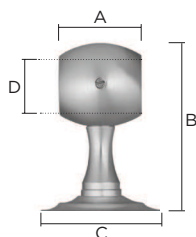

856

30 46 94 69 31

Oro Lucido
Polished Brass

Bronzo Antico
Antique Bronze

Nickel Satinato
Satin Nickel

Cromo Lucido
Chrome Plated

Cromo Satinato
Satin Chrome

Oro Lucido
Polished Brass

Bronzo Antico
Antique Bronze

35 46 109 69 36

Nickel Satinato
Satin Nickel

Cromo Lucido
Chrome Plated

Cromo Satinato
Satin Chrome

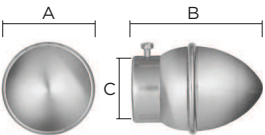
Articolo Item	Misure Sizes				Finitura Finish
	A	B	C	D	
Finali End-knobs	20	32	49	20	Oro Lucido Polished Brass
					Bronzo Antico Antique Bronze
					Nickel Satinato Satin Nickel
					Cromo Lucido Chrome Plated
					Cromo Satinato Satin Chrome
25	42	59	25	Oro Lucido Polished Brass	
				Bronzo Antico Antique Bronze	
				Nickel Satinato Satin Nickel	
				Cromo Lucido Chrome Plated	
				Cromo Satinato Satin Chrome	
 857	30	49	70	30	Oro Lucido Polished Brass
					Bronzo Antico Antique Bronze
					Nickel Satinato Satin Nickel
					Cromo Lucido Chrome Plated
					Cromo Satinato Satin Chrome
35	54	72	35	Oro Lucido Polished Brass	
				Bronzo Antico Antique Bronze	
				Nickel Satinato Satin Nickel	
				Cromo Lucido Chrome Plated	
				Cromo Satinato Satin Chrome	
40	59	75	40	Oro Lucido Polished Brass	
				Bronzo Antico Antique Bronze	
				Nickel Satinato Satin Nickel	
				Cromo Lucido Chrome Plated	
				Cromo Satinato Satin Chrome	

Articolo
Item

Misure
Sizes

Finitura
Finish

A

B

C

D

Supporti per tende
e scale
Curtains and stairs
brackets

Oro Lucido
Polished Brass

Bronzo Antico
Antique Bronze

30

69

119

100

31

Nickel Satinato
Satin Nickel

Cromo Lucido
Chrome Plated

Cromo Satinato
Satin Chrome

Oro Lucido
Polished Brass

Bronzo Antico
Antique Bronze

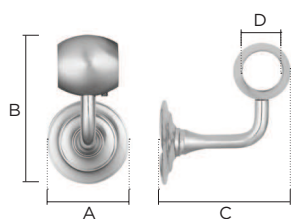

858

35

69

124

103

36

Nickel Satinato
Satin Nickel

Cromo Lucido
Chrome Plated

Cromo Satinato
Satin Chrome

Oro Lucido
Polished Brass

Bronzo Antico
Antique Bronze

40

69

129

105

41

Nickel Satinato
Satin Nickel

Cromo Lucido
Chrome Plated

Cromo Satinato
Satin Chrome

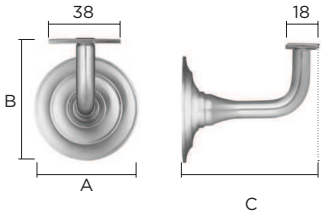
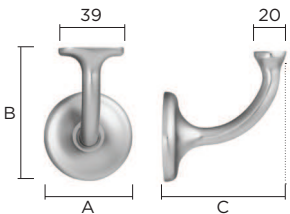
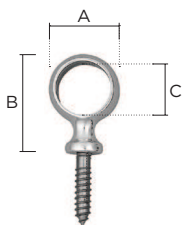
	Articolo Item	Misure Sizes				Finitura Finish
		A	B	C	D	
	Supporti per tende e scale Curtains and stairs brackets 859	75	69	76	84	Oro Lucido Polished Brass
						Bronzo Antico Antique Bronze
						Nickel Satinato Satin Nickel
						Cromo Lucido Chrome Plated
						Cromo Satinato Satin Chrome
	Supporti per tende e scale Curtains and stairs brackets 859 E	65	55	75	75	Oro Lucido Polished Brass
						Bronzo Antico Antique Bronze
						Nickel Satinato Satin Nickel
						Cromo Lucido Chrome Plated
						Cromo Satinato Satin Chrome
	Accessori scala Stairs accessories 860	10	16	23	10	Oro Lucido Polished Brass
						Cromo Lucido Chrome Plated
		12	18	25	12	Oro Lucido Polished Brass
						Cromo Lucido Chrome Plated
		14	20	27	14	Oro Lucido Polished Brass
						Cromo Lucido Chrome Plated
		17	22	31	17	Oro Lucido Polished Brass
						Cromo Lucido Chrome Plated

Supporti per tende
e scale
Curtains and stairs
brackets

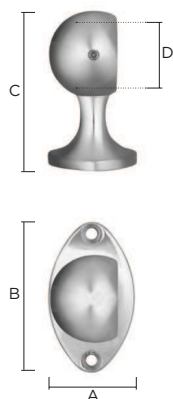

861

Articolo Item	Misure Sizes				Finitura Finish
	A	B	C	D	
11	18	35	30	11	Oro Lucido Polished Brass
					Bronzo Antico Antique Bronze
					Nickel Satinato Satin Nickel
					Cromo Lucido Chrome Plated
13	18	35	30	13	Cromo Satinato Satin Chrome
					Oro Lucido Polished Brass
					Bronzo Antico Antique Bronze
					Nickel Satinato Satin Nickel
25x50 Left/ Right	34	60	88	25	Cromo Lucido Chrome Plated
					Cromo Satinato Satin Chrome
					Oro Lucido Polished Brass
					Bronzo Antico Antique Bronze
30x50 Left/ Right	34	60	90	30	Nickel Satinato Satin Nickel
					Cromo Lucido Chrome Plated
					Cromo Satinato Satin Chrome
					Oro Lucido Polished Brass
30x50 Left/ Right	34	60	90	30	Bronzo Antico Antique Bronze
					Nickel Satinato Satin Nickel
					Cromo Lucido Chrome Plated
					Cromo Satinato Satin Chrome

Supporti per tende
e scale
Curtains and stairs
brackets

11 35 18 30 11

Oro Lucido
Polished Brass

Bronzo Antico
Antique Bronze

Nickel Satinato
Satin Nickel

Cromo Lucido
Chrome Plated

Cromo Satinato
Satin Chrome

13 35 18 30 13

Oro Lucido
Polished Brass

Bronzo Antico
Antique Bronze

Nickel Satinato
Satin Nickel

Cromo Lucido
Chrome Plated

Cromo Satinato
Satin Chrome

861 A

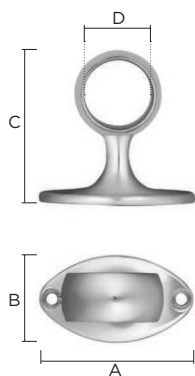

25x30 60 34 58 25

Oro Lucido
Polished Brass

Bronzo Antico
Antique Bronze

Nickel Satinato
Satin Nickel

Cromo Lucido
Chrome Plated

Cromo Satinato
Satin Chrome

25x50 60 34 58 25

Oro Lucido
Polished Brass

Bronzo Antico
Antique Bronze

Nickel Satinato
Satin Nickel

Cromo Lucido
Chrome Plated

Cromo Satinato
Satin Chrome

Supporti per tende
e scale
Curtains and stairs
brackets

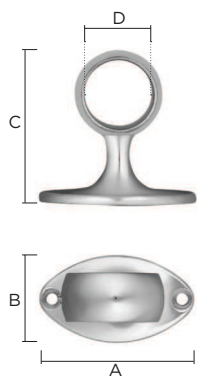

861 A

30x30

60

34

60

30

Oro Lucido
Polished Brass

Bronzo Antico
Antique Bronze

Nickel Satinato
Satin Nickel

Cromo Lucido
Chrome Plated

Cromo Satinato
Satin Chrome

30x50

60

34

90

30

Oro Lucido
Polished Brass

Bronzo Antico
Antique Bronze

Nickel Satinato
Satin Nickel

Cromo Lucido
Chrome Plated

Cromo Satinato
Satin Chrome

Supporti per tende
e scale
Curtains and stairs
brackets

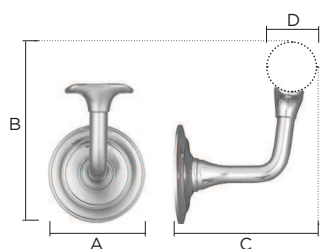

863

30/35

69

116

92

30/35

Oro Lucido
Polished Brass

Bronzo Antico
Antique Bronze

Nickel Satinato
Satin Nickel

Cromo Lucido
Chrome Plated

Cromo Satinato
Satin Chrome

40

69

127

98

40

Oro Lucido
Polished Brass

Bronzo Antico
Antique Bronze

Nickel Satinato
Satin Nickel

Cromo Lucido
Chrome Plated

Cromo Satinato
Satin Chrome

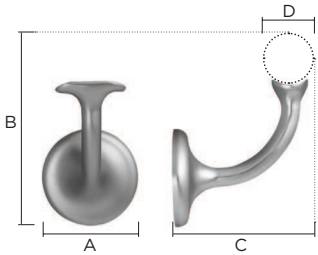
Articolo Item	Misure Sizes				Finitura Finish	
	A	B	C	D		
 <p>863 E</p>	30/35	55	103	80	30/35	Oro Lucido Polished Brass
						Bronzo Antico Antique Bronze
						Nickel Satinato Satin Nickel
						Cromo Lucido Chrome Plated
						Cromo Satinato Satin Chrome
	40	55	113	85	40	Oro Lucido Polished Brass
						Bronzo Antico Antique Bronze
						Nickel Satinato Satin Nickel
						Cromo Lucido Chrome Plated
						Cromo Satinato Satin Chrome

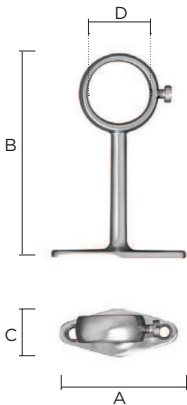
 <p>865</p>	16	44	54	20	16	Oro Lucido Polished Brass
						Cromo Lucido Chrome Plated
	20	48	64	20	20	Oro Lucido Polished Brass
						Cromo Lucido Chrome Plated
	25	53	81	20	25	Oro Lucido Polished Brass
						Cromo Lucido Chrome Plated

Articolo
Item

Misure
Sizes

Finitura
Finish

A

B

C

D

Supporti per tende
e scale
Curtains and stairs
brackets

30x140

140

$\frac{163}{240}$

$\frac{140}{220}$

30

Oro Lucido
Polished Brass

Bronzo Antico
Antique Bronze

30x200

140

$\frac{223}{293}$

$\frac{200}{270}$

30

Oro Lucido
Polished Brass

Bronzo Antico
Antique Bronze

35x140

140

$\frac{165}{240}$

$\frac{140}{220}$

35

Oro Lucido
Polished Brass

Bronzo Antico
Antique Bronze

35x200

140

$\frac{225}{295}$

$\frac{200}{270}$

35

Oro Lucido
Polished Brass

Bronzo Antico
Antique Bronze

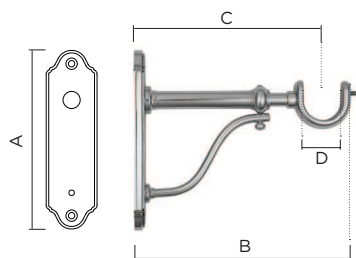

867

Supporti per tende
e scale
Curtains and stairs
brackets

140

140

$\frac{242}{322}$

25

30

Oro Lucido
Polished Brass

Bronzo Antico
Antique Bronze

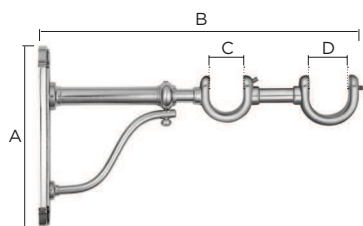

867 D

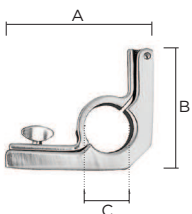
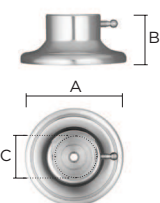
Articolo Item	Misure Sizes				Finitura Finish	
	A	B	C	D		
<p>Accessori scala Stairs accessories</p>  <p>868</p>	12	44	37	12	<p>Oro Lucido Polished Brass</p> <hr/> <p>Cromo Lucido Chrome Plated</p>	
	14	44	37	14	<p>Oro Lucido Polished Brass</p> <hr/> <p>Cromo Lucido Chrome Plated</p>	
	16	44	37	16	<p>Oro Lucido Polished Brass</p> <hr/> <p>Cromo Lucido Chrome Plated</p>	
	<hr/>					
	<p>Supporti per tende e scale Curtains and stairs brackets</p>  <p>869</p>	20	64	34	20	<p>Oro Lucido Polished Brass</p> <hr/> <p>Bronzo Antico Antique Bronze</p> <hr/> <p>Cromo Lucido Chrome Plated</p> <hr/> <p>Cromo Satinato Satin Chrome</p>
		25	69	35	25	<p>Oro Lucido Polished Brass</p> <hr/> <p>Bronzo Antico Antique Bronze</p> <hr/> <p>Cromo Lucido Chrome Plated</p> <hr/> <p>Cromo Satinato Satin Chrome</p>
30		76	35	30	<p>Oro Lucido Polished Brass</p> <hr/> <p>Bronzo Antico Antique Bronze</p> <hr/> <p>Cromo Lucido Chrome Plated</p> <hr/> <p>Cromo Satinato Satin Chrome</p>	
<hr/>						

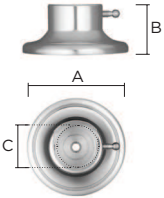
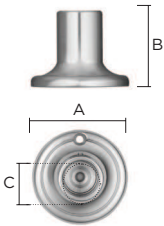
Articolo Item	Misure Sizes				Finitura Finish
	A	B	C	D	
<p>Supporti per tende e scale Curtains and stairs brackets</p> <p>869</p> 	35	76	35	35	Oro Lucido Polished Brass
					Bronzo Antico Antique Bronze
					Cromo Lucido Chrome Plated
					Cromo Satinato Satin Chrome
	40	76	35	35	Oro Lucido Polished Brass
					Bronzo Antico Antique Bronze
					Cromo Lucido Chrome Plated
					Cromo Satinato Satin Chrome
<p>Supporti per tende e scale Curtains and stairs brackets</p> <p>869 C</p> 	20	64	53	20	Oro Lucido Polished Brass
					Bronzo Antico Antique Bronze
					Cromo Lucido Chrome Plated
					Cromo Satinato Satin Chrome
	25	69	53	25	Oro Lucido Polished Brass
					Bronzo Antico Antique Bronze
					Cromo Lucido Chrome Plated
					Cromo Satinato Satin Chrome
30	76	53	30	Oro Lucido Polished Brass	
				Bronzo Antico Antique Bronze	
				Cromo Lucido Chrome Plated	
				Cromo Satinato Satin Chrome	

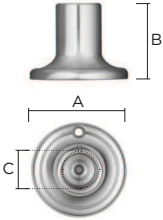
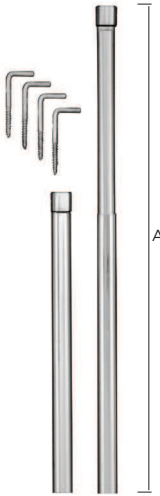
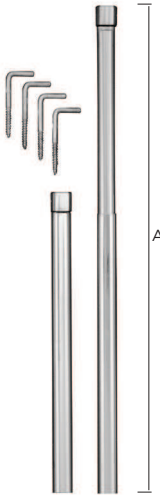
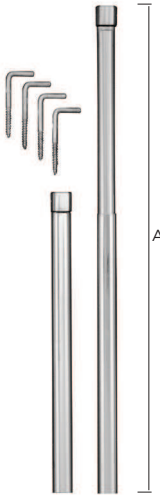
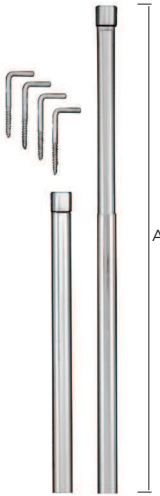
Articolo Item	Misure Sizes				Finitura Finish
	A	B	C	D	
<p>Supporti per tende e scale Curtains and stairs brackets</p>  <p>869 C</p>	35	76	53	35	Oro Lucido Polished Brass
					Bronzo Antico Antique Bronze
					Cromo Lucido Chrome Plated
					Cromo Satinato Satin Chrome
<p>Accessori tende Curtains accessories</p>  <p>870</p>	30	300 - 500	500	500	Oro Lucido Polished Brass
					Oro Lucido Polished Brass
					Oro Lucido Polished Brass
					Oro Lucido Polished Brass
<p>Accessori tende Curtains accessories</p>  <p>870</p>	40	400 - 600	600	600	Oro Lucido Polished Brass
					Oro Lucido Polished Brass
					Oro Lucido Polished Brass
					Oro Lucido Polished Brass
<p>Accessori tende Curtains accessories</p>  <p>870</p>	50	500 - 800	800	800	Oro Lucido Polished Brass
					Oro Lucido Polished Brass
					Oro Lucido Polished Brass
					Oro Lucido Polished Brass
<p>Accessori tende Curtains accessories</p>  <p>870</p>	60	600 - 1000	1000	1000	Oro Lucido Polished Brass
					Oro Lucido Polished Brass
					Oro Lucido Polished Brass
					Oro Lucido Polished Brass

Articolo
Item

Misure
Sizes

Finitura
Finish

A

B

C

D

Accessori scala
Curtains accessories

Oro Lucido
Polished Brass

Bronzo Antico
Antique Bronze

120 70 127 60

Nickel Satinato
Satin Nickel

Cromo Lucido
Chrome Plated

Cromo Satinato
Satin Chrome

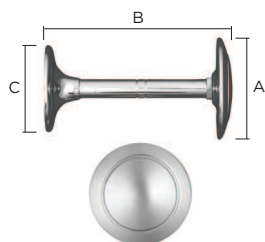

872

Oro Lucido
Polished Brass

Bronzo Antico
Antique Bronze

180 70 187 60

Nickel Satinato
Satin Nickel

Cromo Lucido
Chrome Plated

Cromo Satinato
Satin Chrome

Supporti tenda
Curtains brackets

Oro Lucido
Polished Brass

16 48 59 20 16

Cromo Satinato
Satin Chrome

Oro Lucido
Polished Brass

20 48 61 20 20

Cromo Satinato
Satin Chrome

Oro Lucido
Polished Brass

25 48 62 20 25

Cromo Satinato
Satin Chrome

Oro Lucido
Polished Brass

30 48 65 20 30

Cromo Satinato
Satin Chrome

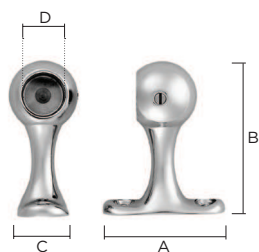

874

Left/Right

Articolo
Item

Misure
Sizes

Finitura
Finish

A

B

C

D

Supporti tenda
Curtains brackets

Oro Lucido
Polished Brass

16 48 59 20 16

Cromo Satinato
Satin Chrome

Oro Lucido
Polished Brass

20 48 61 20 20

Cromo Satinato
Satin Chrome

Oro Lucido
Polished Brass

25 48 62 20 25

Cromo Satinato
Satin Chrome

Oro Lucido
Polished Brass

30 48 65 20 30

Cromo Satinato
Satin Chrome

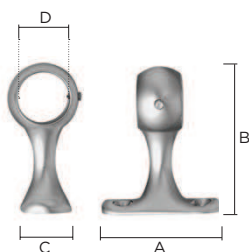

874 A

Accessori tende
Curtains accessories

Oro Lucido
Polished Brass

1500 17 1500

Cromo Satinato
Satin Chrome

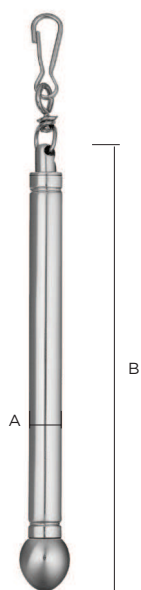

879

Articolo
Item

Misure
Sizes

Finitura
Finish

A

B

C

D

Supporti tenda
Curtains brackets

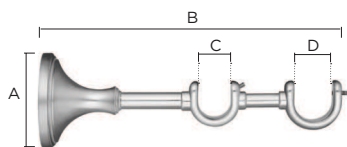

880

25/30

74

233

25

30

Oro Lucido
Polished Brass

Bronzo Antico
Antique Bronze

Finali
End-knobs

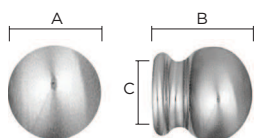

883

11

20

21

11

Oro Lucido
Polished Brass

Bronzo Antico
Antique Bronze

Nickel Satinato
Satin Nickel

Cromo Lucido
Chrome Plated

Cromo Satinato
Satin Chrome

Oro Lucido
Polished Brass

Bronzo Antico
Antique Bronze

13

22

23

13

Nickel Satinato
Satin Nickel

Cromo Lucido
Chrome Plated

Cromo Satinato
Satin Chrome

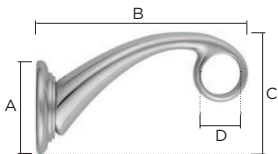
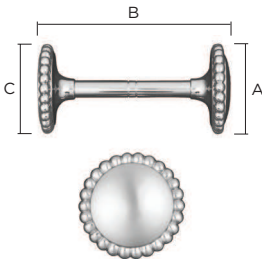
Articolo Item	Misure Sizes				Finitura Finish	
	A	B	C	D		
<p>Supporti tenda Curtains brackets</p>  <p>888</p>					Oro Lucido Polished Brass	
	25	69	152	85	25	Cromo Lucido Chrome Plated
						Cromo Satinato Satin Chrome
						Oro Lucido Polished Brass
	30	69	157	90	30	Cromo Lucido Chrome Plated
						Cromo Satinato Satin Chrome
					Oro Lucido Polished Brass	
	35	69	163	90	35	Cromo Lucido Chrome Plated
					Cromo Satinato Satin Chrome	
<p>Accessori tende Curtains accessories</p>  <p>899</p>					Oro Lucido Polished Brass	
	120	69	144	69		Bronzo Antico Antique Bronze
						Cromo Lucido Chrome Plated
						Oro Lucido Polished Brass
	180	69	204	69		Bronzo Antico Antique Bronze
						Cromo Lucido Chrome Plated

Articolo
Item

Misure
Sizes

A B C D

Finitura
Finish

Finali
End-knobs

Oro Lucido
Polished Brass

Bronzo Antico
Antique Bronze

20 24 8 20

Nickel Satinato
Satin Nickel

Cromo Lucido
Chrome Plated

Cromo Satinato
Satin Chrome

Oro Lucido
Polished Brass

Bronzo Antico
Antique Bronze

Nickel Satinato
Satin Nickel

Cromo Lucido
Chrome Plated

Cromo Satinato
Satin Chrome

Oro Lucido
Polished Brass

Bronzo Antico
Antique Bronze

30 34 13 30

Nickel Satinato
Satin Nickel

Cromo Lucido
Chrome Plated

Cromo Satinato
Satin Chrome

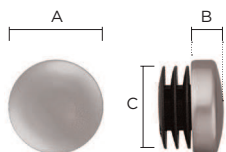

900



Articolo
Item

Misure
Sizes

A B C D

Finitura
Finish

Finali
End-knobs

Oro Lucido
Polished Brass

Bronzo Antico
Antique Bronze

35 40 14 35

Nickel Satinato
Satin Nickel

Cromo Lucido
Chrome Plated

Cromo Satinato
Satin Chrome

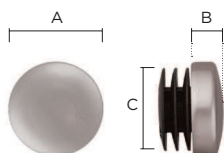

900

Oro Lucido
Polished Brass

Bronzo Antico
Antique Bronze

40 44 15 40

Nickel Satinato
Satin Nickel

Cromo Lucido
Chrome Plated

Cromo Satinato
Satin Chrome

Accessori tende
Curtains accessories

Oro Lucido
Polished Brass

Bronzo Antico
Antique Bronze

13 25 32 19

Nickel Satinato
Satin Nickel

Cromo Lucido
Chrome Plated

Cromo Satinato
Satin Chrome

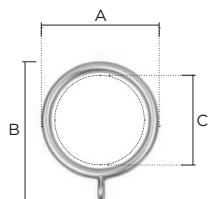

901

Articolo
Item

Misure
Sizes

Finitura
Finish

A

B

C

D

Accessori tende
Curtains accessories

Oro Lucido
Polished Brass

Bronzo Antico
Antique Bronze

20 33 43 26

Nickel Satinato
Satin Nickel

Cromo Lucido
Chrome Plated

Cromo Satinato
Satin Chrome

Oro Lucido
Polished Brass

Bronzo Antico
Antique Bronze

25 40 51 31

Nickel Satinato
Satin Nickel

Cromo Lucido
Chrome Plated

Cromo Satinato
Satin Chrome

901

Oro Lucido
Polished Brass

Bronzo Antico
Antique Bronze

30 46 57 36

Nickel Satinato
Satin Nickel

Cromo Lucido
Chrome Plated

Cromo Satinato
Satin Chrome

Oro Lucido
Polished Brass

Bronzo Antico
Antique Bronze

35 52 63 41

Nickel Satinato
Satin Nickel

Cromo Lucido
Chrome Plated

Cromo Satinato
Satin Chrome

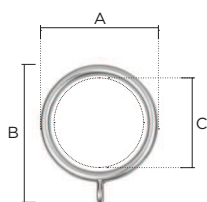

Accessori tende
Curtains accessories

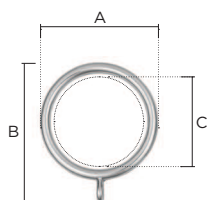

901

40

60

71

49

Oro Lucido
Polished Brass

Bronzo Antico
Antique Bronze

Nickel Satinato
Satin Nickel

Cromo Lucido
Chrome Plated

Cromo Satinato
Satin Chrome

Accessori tende
Curtains accessories

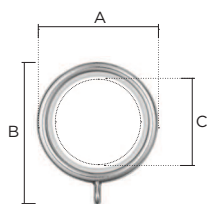

901 N

25

40

51

29

Oro Lucido
Polished Brass

Bronzo Antico
Antique Bronze

Nickel Satinato
Satin Nickel

Cromo Lucido
Chrome Plated

Cromo Satinato
Satin Chrome

Oro Lucido
Polished Brass

Bronzo Antico
Antique Bronze

Nickel Satinato
Satin Nickel

Cromo Lucido
Chrome Plated

Cromo Satinato
Satin Chrome

Articolo
Item

Misure
Sizes

Finitura
Finish

A B C D

Accessori tende
Curtains accessories

Oro Lucido
Polished Brass

Bronzo Antico
Antique Bronze

35 52 63 38

Nickel Satinato
Satin Nickel

Cromo Lucido
Chrome Plated

Cromo Satinato
Satin Chrome

901 N

Oro Lucido
Polished Brass

Bronzo Antico
Antique Bronze

40 60 71 46

Nickel Satinato
Satin Nickel

Cromo Lucido
Chrome Plated

Cromo Satinato
Satin Chrome

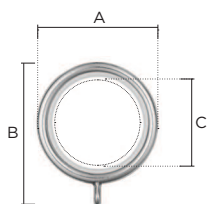

Accessori tende
Curtains accessories

Oro Lucido
Polished Brass

Bronzo Antico
Antique Bronze

11 14 14 10 4

Nickel Satinato
Satin Nickel

Cromo Lucido
Chrome Plated

Cromo Satinato
Satin Chrome

903

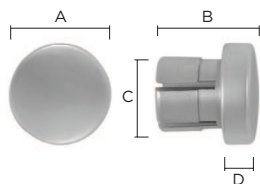

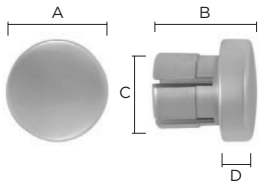
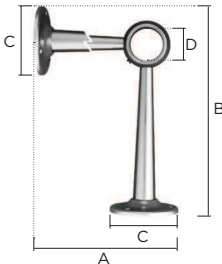
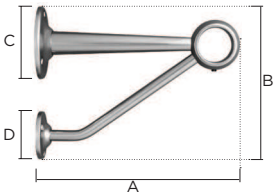
Articolo Item	Misure Sizes				Finitura Finish	
	A	B	C	D		
<p>Accessori tende Curtains accessories</p>  <p>903</p>	13	16	15	12	5	<p>Oro Lucido Polished Brass</p> <hr/> <p>Bronzo Antico Antique Bronze</p> <hr/> <p>Nickel Satinato Satin Nickel</p> <hr/> <p>Cromo Lucido Chrome Plated</p> <hr/> <p>Cromo Satinato Satin Chrome</p>
<p>Poggiapiedi Brackets for footrest</p>  <p>1000</p>	35	211	211	76	35	<p>Oro Lucido Polished Brass</p> <hr/> <p>Nickel Satinato Satin Nickel</p> <hr/> <p>Cromo Lucido Chrome Plated</p>
<p>Poggiapiedi Brackets for footrest</p>  <p>1001</p>	35	211	160	76	51	<p>Oro Lucido Polished Brass</p> <hr/> <p>Nickel Satinato Satin Nickel</p> <hr/> <p>Cromo Lucido Chrome Plated</p>

Articolo
Item

Misure
Sizes

Finitura
Finish

A

B

C

D

Puntali
Cabin feet

Oro Lucido
Polished Brass

21 28 24 19

Bronzo Antico Etrusco
Etruscan Antique Bronze

Oro Lucido
Polished Brass

23 31 26 21

Bronzo Antico Etrusco
Etruscan Antique Bronze

Oro Lucido
Polished Brass

25 34 28 23

Bronzo Antico Etrusco
Etruscan Antique Bronze

Oro Lucido
Polished Brass

30 41 32 27

Bronzo Antico Etrusco
Etruscan Antique Bronze



Oro Lucido
Polished Brass

35 46 35 31

Bronzo Antico Etrusco
Etruscan Antique Bronze

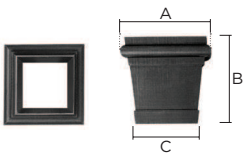

1010

Articolo Item	Misure Sizes				Finitura Finish	
	A	B	C	D		
<p>Puntali Cabin feet</p>  <p>1015</p>	25	33	32	22	<p>Oro Lucido Polished Brass</p> <hr/> <p>Bronzo Antico Etrusco Etruscan Antique Bronze</p>	
	30	39	37	27	<p>Oro Lucido Polished Brass</p> <hr/> <p>Bronzo Antico Etrusco Etruscan Antique Bronze</p>	
	35	44	40	31	<p>Oro Lucido Polished Brass</p> <hr/> <p>Bronzo Antico Etrusco Etruscan Antique Bronze</p>	
	<hr/>					
	<p>Piedini Cabin feet</p>  <p>1025</p>	100	32	100	25	<p>Oro Lucido Polished Brass</p> <hr/> <p>Nickel Satinato Satin Nickel</p>
						<p>Cromo Lucido Chrome Plated</p>
150		32	150	25	<p>Oro Lucido Polished Brass</p> <hr/> <p>Nickel Satinato Satin Nickel</p> <hr/> <p>Cromo Lucido Chrome Plated</p>	

Articolo
Item

Misure
Sizes

Finitura
Finish

A

B

C

D

Piedini
Cabin feet

Oro Lucido
Polished Brass

100 40 100 25

Nickel Satinato
Satin Nickel

Cromo Lucido
Chrome Plated

1026

Oro Lucido
Polished Brass

150 40 150 25

Nickel Satinato
Satin Nickel

Cromo Lucido
Chrome Plated



Piedini
Cabin feet

Oro Lucido
Polished Brass

100 32 100 25

Nickel Satinato
Satin Nickel

Cromo Lucido
Chrome Plated

1029

Oro Lucido
Polished Brass

150 32 150 25

Nickel Satinato
Satin Nickel

Cromo Lucido
Chrome Plated

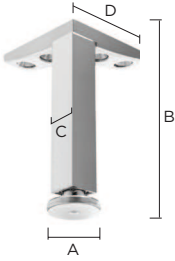
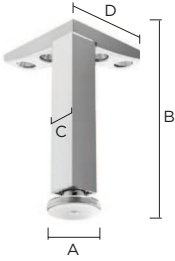
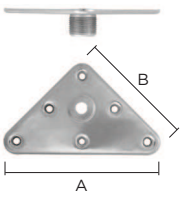
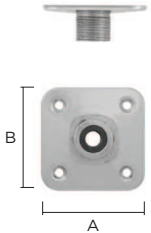

Articolo Item	Misure Sizes				Finitura Finish		
	A	B	C	D			
Piedini Cabin feet 	1040	120	32	120	20	72	Oro Lucido Polished Brass
							Nickel Satinato Satin Nickel
							Cromo Lucido Chrome Plated
Piedini Cabin feet 	150	32	150	20	72	Oro Lucido Polished Brass	
						Nickel Satinato Satin Nickel	
						Cromo Lucido Chrome Plated	
Piedini Cabin feet 	AP01	95	126	95			Cromo Lucido Chrome Plated
Piedini Cabin feet 	AP02	60	60	60			Cromo Lucido Chrome Plated

Articolo
Item

Misure
Sizes

Finitura
Finish

A

B

C

D

Piedini
Cabin feet

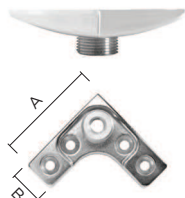

AP04

72

72

25

Oro Lucido
Polished Brass

Nickel Satinato
Satin Nickel

Cromo Lucido
Chrome Plated

Fregi per piedino mobile
Decorations for cabinet
feet



1060

35

98

Oro Lucido
Polished Brass

Bronzo Antico Etrusco
Etruscan Antique Bronze

Fregi per piedino mobile
Decorations for cabinet
feet





1061

31

81

Oro Lucido
Polished Brass

Bronzo Antico Etrusco
Etruscan Antique Bronze

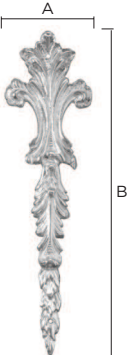
Articolo Item	Misure Sizes				Finitura Finish
	A	B	C	D	
<p>Cimase Decorations</p>  <p>1062 CM</p>	37	206			<p>Oro Lucido Polished Brass</p> <hr/> <p>Bronzo Antico Etrusco Etruscan Antique Bronze</p>
<p>Fregi per piedino mobile Decorations for cabinet feet</p>  <p>1062 PI</p>	46	117			<p>Oro Lucido Polished Brass</p> <hr/> <p>Bronzo Antico Etrusco Etruscan Antique Bronze</p>
<p>Cimase Decorations</p>  <p>1063 CM</p>	48	182			<p>Oro Lucido Polished Brass</p> <hr/> <p>Bronzo Antico Etrusco Etruscan Antique Bronze</p>

Articolo
Item

Misure
Sizes

Finitura
Finish

A

B

C

D

Fregi per piedino mobile
Decorations for cabinet
feet



1063 PI

28 87

Oro Lucido
Polished Brass

Bronzo Antico Etrusco
Etruscan Antique Bronze

Cimase
Decorations

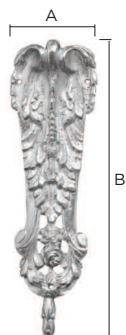

1064 CM

43 154

Oro Lucido
Polished Brass

Bronzo Antico Etrusco
Etruscan Antique Bronze

Fregi per piedino mobile
Decorations for cabinet
feet

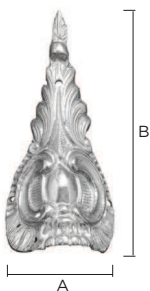

1064 PI

36 91

Oro Lucido
Polished Brass

Bronzo Antico Etrusco
Etruscan Antique Bronze

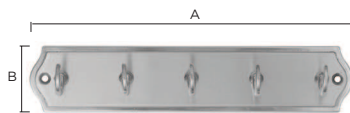
	Articolo Item	Misure Sizes				Finitura Finish
		A	B	C	D	
	Cimase Decorations	13	31	131	Oro Lucido Polished Brass	
					Bronzo Antico Etrusco Etruscan Antique Bronze	
					1070	14
Bronzo Antico Etrusco Etruscan Antique Bronze						
		23	54	226	Oro Lucido Polished Brass	
					Bronzo Antico Etrusco Etruscan Antique Bronze	
					Fregi Decorations	16
Bronzo Antico Etrusco Etruscan Antique Bronze						
1071	21	37	216	Oro Lucido Polished Brass		
Bronzo Antico Etrusco Etruscan Antique Bronze						
	Appendiabiti Coat hangers	1504	200	41	Oro Lucido Polished Brass	
					Cromo Lucido Chrome Plated	

Articolo
Item

Misure
Sizes

Finitura
Finish

A

B

C

D

Ganci
Hooks

Oro Lucido
Polished Brass

Bronzo Antico Etrusco
Etruscan Antique Bronze

20 22 18

Nickel Lucido
Nickel Plated

Nickel Satinato
Satin Nickel

Cromo Lucido
Chrome Plated

Oro Lucido
Polished Brass

Bronzo Antico Etrusco
Etruscan Antique Bronze

28 29 22

Nickel Lucido
Nickel Plated

Nickel Satinato
Satin Nickel

Cromo Lucido
Chrome Plated

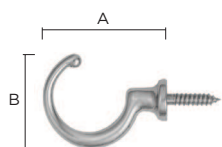

1505

Oro Lucido
Polished Brass

Bronzo Antico Etrusco
Etruscan Antique Bronze

35 35 27

Nickel Lucido
Nickel Plated

Nickel Satinato
Satin Nickel

Cromo Lucido
Chrome Plated

Oro Lucido
Polished Brass

Bronzo Antico Etrusco
Etruscan Antique Bronze

42 42 32

Nickel Lucido
Nickel Plated

Nickel Satinato
Satin Nickel

Cromo Lucido
Chrome Plated

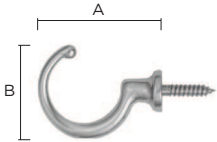
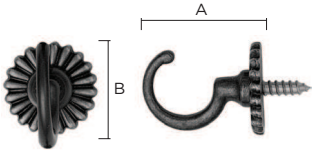

Articolo Item	Misure Sizes				Finitura Finish
	A	B	C	D	
<p>Ganci Hooks</p>  <p>1505</p>	50	51	38	Oro Lucido Polished Brass	
				Bronzo Antico Etrusco Etruscan Antique Bronze	
				Nickel Lucido Nickel Plated	
				Nickel Satinato Satin Nickel	
				Cromo Lucido Chrome Plated	
<p>Ganci Hooks</p>  <p>1506</p>	20	25	34	Oro Lucido Polished Brass	
				Bronzo Antico Etrusco Etruscan Antique Bronze	
	28	32	24	Oro Lucido Polished Brass	
				Bronzo Antico Etrusco Etruscan Antique Bronze	
	35	38	27	Oro Lucido Polished Brass	
				Bronzo Antico Etrusco Etruscan Antique Bronze	
	42	45	33	Oro Lucido Polished Brass	
				Bronzo Antico Etrusco Etruscan Antique Bronze	
	50	54	33	Oro Lucido Polished Brass	
				Bronzo Antico Etrusco Etruscan Antique Bronze	

Articolo
Item

Misure
Sizes

Finitura
Finish

A

B

C

D

Ganci
Hooks

Oro Lucido
Polished Brass

25 25 25

Bronzo Antico Etrusco
Etruscan Antique Bronze



1509

Oro Lucido
Polished Brass

35 35 35

Bronzo Antico Etrusco
Etruscan Antique Bronze

Oro Lucido
Polished Brass

45 45 45

Bronzo Antico Etrusco
Etruscan Antique Bronze

Ganci
Hooks

Oro Lucido
Polished Brass

30 15 30

Bronzo Antico Etrusco
Etruscan Antique Bronze



1510

Oro Lucido
Polished Brass

50 23 45

Bronzo Antico Etrusco
Etruscan Antique Bronze

Oro Lucido
Polished Brass



75 35 75

Bronzo Antico Etrusco
Etruscan Antique Bronze

Oro Lucido
Polished Brass

100 46 100

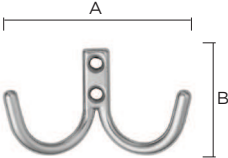
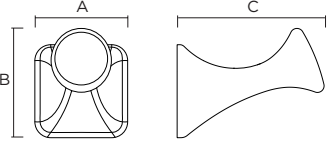
Bronzo Antico Etrusco
Etruscan Antique Bronze

Articolo Item	Misure Sizes				Finitura Finish
	A	B	C	D	
 <p>Appendiabiti Coat hangers</p> <p>1516</p>		82	28		<p>Oro Lucido Polished Brass</p> <hr/> <p>Cromo Lucido Chrome Plated</p>
 <p>Appendiabiti Coat hangers</p> <p>1517</p>	35	35	41	55	<p>Oro Lucido Polished Brass</p> <hr/> <p>Cromo Lucido Chrome Plated</p> <hr/> <p>Cromo Satinato Satin Chrome</p>
 <p>Ganci Hooks</p> <p>1520</p>	30	18	30		<p>Oro Lucido Polished Brass</p> <hr/> <p>Bronzo Antico Etrusco Etruscan Antique Bronze</p> <hr/> <p>Oro Lucido Polished Brass</p> <hr/> <p>Bronzo Antico Etrusco Etruscan Antique Bronze</p> <hr/> <p>Oro Lucido Polished Brass</p> <hr/> <p>Bronzo Antico Etrusco Etruscan Antique Bronze</p> <hr/> <p>Oro Lucido Polished Brass</p> <hr/> <p>Bronzo Antico Etrusco Etruscan Antique Bronze</p>
	50	30	53		
	75	45	86		
	100	60	111		

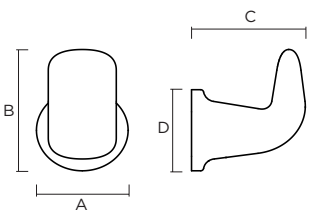
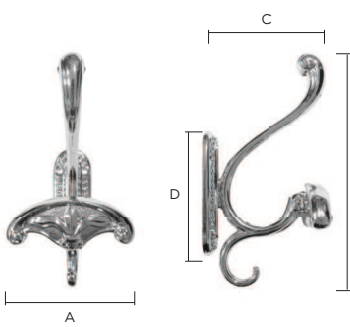
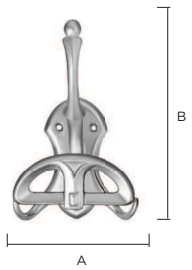
	Articolo Item	Misure Sizes				Finitura Finish	
		A	B	C	D		
	<p>Appendiabiti Coat hangers</p> <p>1522</p>	31	41	38	27	<p>Oro Lucido Polished Brass</p> <hr/> <p>Cromo Lucido Chrome Plated</p> <hr/> <p>Cromo Satinato Satin Chrome</p>	
		<p>Appendiabiti Coat hangers</p> <p>1535</p>	73	148	73	79	<p>Oro Lucido Polished Brass</p> <hr/> <p>Bronzo Antico Antique Bronze</p> <hr/> <p>Oro Antico Antique Gold</p>
		<p>Appendiabiti Coat hangers</p> <p>1540</p>	100	151			<p>Oro Lucido Polished Brass</p> <hr/> <p>Bronzo Antico Antique Bronze</p>

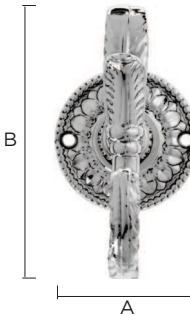
	Articolo Item	Misure Sizes				Finitura Finish
		A	B	C	D	
	<p>Appendiabiti Coat hangers</p> <p>C58000</p>	44	44	70	<p>Oro Lucido Polished Brass</p> <hr/> <p>Bronzo Antico Antique Bronze</p>	
	<p>Appendiabiti Coat hangers</p> <p>C58100</p>	46	46	87	<p>Oro Lucido Polished Brass</p> <hr/> <p>Bronzo Antico Antique Bronze</p>	
	<p>Appendiabiti Coat hangers</p> <p>C58200</p>	34	34	74	<p>Oro Lucido Polished Brass</p> <hr/> <p>Bronzo Antico Antique Bronze</p>	

Articolo
Item

Misure
Sizes

Finitura
Finish

A B C D

Sistema reling
Reling system

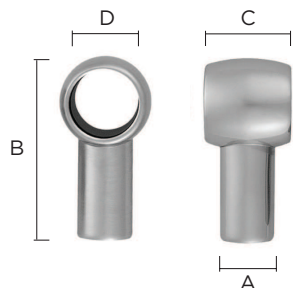

2000

16 14 46 22 16

Oro Lucido
Polished Brass

Nickel Satinato
Satin Nickel

Cromo Lucido
Chrome Plated

Cromo Satinato
Satin Chrome

Reggimensole
Shelf-brackets

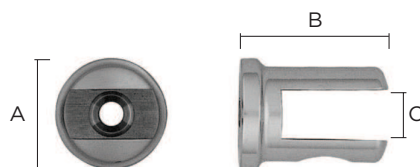

2000 M

8 20 26 8

Oro Lucido
Polished Brass

Nickel Satinato
Satin Nickel

Cromo Lucido
Chrome Plated

Cromo Satinato
Satin Chrome

Oro Lucido
Polished Brass

Nickel Satinato
Satin Nickel

Cromo Lucido
Chrome Plated

Cromo Satinato
Satin Chrome

10 24 28 10

Sistema reling
Reling system

Oro Lucido
Polished Brass

Nickel Satinato
Satin Nickel

11x40 14 40 11

Cromo Lucido
Chrome Plated

Cromo Satinato
Satin Chrome

Oro Lucido
Polished Brass

Nickel Satinato
Satin Nickel

2001

11x70 14 70 11

Cromo Lucido
Chrome Plated

Cromo Satinato
Satin Chrome

Oro Lucido
Polished Brass

Nickel Satinato
Satin Nickel

13x40 18 41 13

Cromo Lucido
Chrome Plated

Cromo Satinato
Satin Chrome

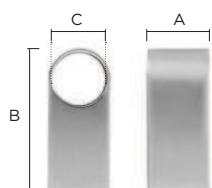

Articolo
Item

Misure
Sizes

Finitura
Finish

A B C D

Sistema reling
Reling system

Oro Lucido
Polished Brass

Nickel Satinato
Satin Nickel

13x70 18 70 13

Cromo Lucido
Chrome Plated

Cromo Satinato
Satin Chrome

Oro Lucido
Polished Brass

Nickel Satinato
Satin Nickel

2001

16x40 20 45 16

Cromo Lucido
Chrome Plated

Cromo Satinato
Satin Chrome

Oro Lucido
Polished Brass

Nickel Satinato
Satin Nickel

16x70 20 70 16

Cromo Lucido
Chrome Plated

Cromo Satinato
Satin Chrome

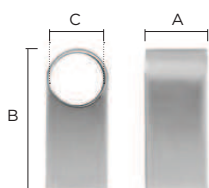

Articolo
Item

Misure
Sizes

Finitura
Finish

A B C D

Reggimensole
Shelf-brackets

Oro Lucido
Polished Brass

Nickel Satinato
Satin Nickel

6 20 20 26 6

Cromo Lucido
Chrome Plated

Cromo Satinato
Satin Chrome

Oro Lucido
Polished Brass

Nickel Satinato
Satin Nickel

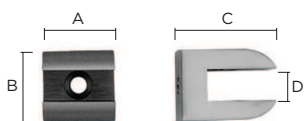

2001 M

8 20 20 26 8

Cromo Lucido
Chrome Plated

Cromo Satinato
Satin Chrome

Oro Lucido
Polished Brass

Nickel Satinato
Satin Nickel

10 24 24 28 10

Cromo Lucido
Chrome Plated

Cromo Satinato
Satin Chrome

Articolo
Item

Misure
Sizes

Finitura
Finish

A B C D

Sistema reling
Reling system

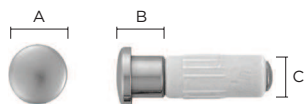

2010

16 18 11 16

Oro Lucido
Polished Brass

Nickel Satinato
Satin Nickel

Cromo Lucido
Chrome Plated

Cromo Satinato
Satin Chrome

Sistema reling
Reling system

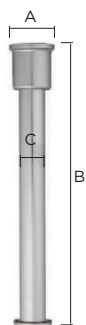

2025

1000 35 900 20

Oro Lucido
Polished Brass

Cromo Lucido
Chrome Plated

Oro Lucido
Polished Brass

1200 35 1115 20

Cromo Lucido
Chrome Plated

Appendiabiti
Coat hangers

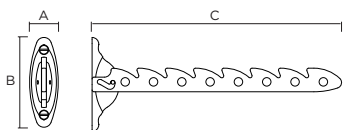

2070

265 30 95 265

Oro Lucido
Polished Brass

Cromo Lucido
Chrome Plated

Sistema reling
Reling system

Oro Lucido
Polished Brass

Nickel Satinato
Satin Nickel

100 16 1000

Cromo Lucido
Chrome Plated

Cromo Satinato
Satin Chrome

Oro Lucido
Polished Brass

Nickel Satinato
Satin Nickel

150 16 1500

Cromo Lucido
Chrome Plated

Cromo Satinato
Satin Chrome

3075

Oro Lucido
Polished Brass

Nickel Satinato
Satin Nickel

200 16 2000

Cromo Lucido
Chrome Plated

Cromo Satinato
Satin Chrome

Oro Lucido
Polished Brass

Nickel Satinato
Satin Nickel

250 16 2500

Cromo Lucido
Chrome Plated

Cromo Satinato
Satin Chrome



Articolo
Item

Misure
Sizes

Finitura
Finish

A B C D

Sistema reling
Reling system

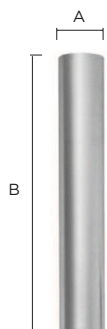

3075

300 16 3000

Oro Lucido
Polished Brass

Nickel Satinato
Satin Nickel

Cromo Lucido
Chrome Plated

Cromo Satinato
Satin Chrome

Sistema reling
Reling system

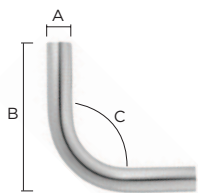

3075 C

16x90 16 94 90

Oro Lucido
Polished Brass

Nickel Satinato
Satin Nickel

Cromo Lucido
Chrome Plated

Cromo Satinato
Satin Chrome

Reggimensole
Shelf Brackets

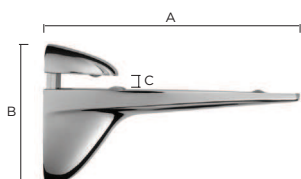

PF2000

170 99 5/10

Oro Lucido
Polished Brass

Cromo Lucido
Chrome Plated

Cromo Satinato
Satin Chrome

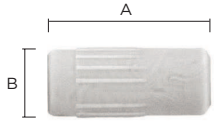
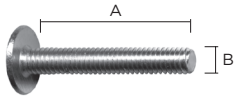
	Articolo Item	Misure Sizes				Finitura Finish
		A	B	C	D	
	Accessori Accessories					
	*CV001	31	13			Zincata Zincated Steel
	Accessori Accessories					
	SV	075	25	M4		Zincata Zincated Steel
		080	50	M4		Zincata Zincated Steel
		081	55	M4		Zincata Zincated Steel

Articolo
Item

Misure
Sizes

Finitura
Finish

A

B

C

D

Accessori
Accessories

Oro Lucido
Polished Brass

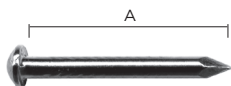

SV114

17

17

Bronzo Antico
Antique Bronze

Nickel Lucido
Nickel Plated

Accessori
Accessories

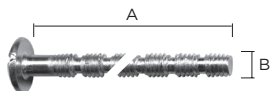

SV128

45

M4

Zincata
Zincated Steel

.....
ACCIAIO INOX
STAINLESS STEEL

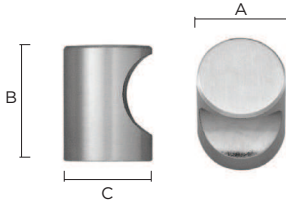
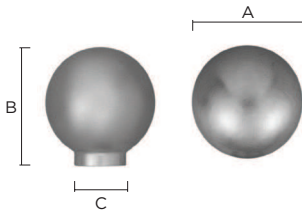
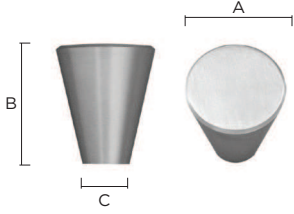
	Articolo Item	Misure Sizes				Finitura Finish
		A	B	C	D	
	Pomoli acciaio inox Stainless steel knobs					Acciaio Satinato Satin Stainless Steel
	AI 0153	15	15	22	15	Acciaio Lucido Bright Stainless Steel
		18	18	25	18	Acciaio Satinato Satin Stainless Steel
						Acciaio Lucido Bright Stainless Steel
		21	21	27	21	Acciaio Satinato Satin Stainless Steel
						Acciaio Lucido Bright Stainless Steel
	Pomoli acciaio inox Stainless steel knobs					Acciaio Satinato Satin Stainless Steel
	AI 0180	20	20	22	10	Acciaio Lucido Bright Stainless Steel
		25	25	27	12	Acciaio Satinato Satin Stainless Steel
						Acciaio Lucido Bright Stainless Steel
		30	30	32	14	Acciaio Satinato Satin Stainless Steel
						Acciaio Lucido Bright Stainless Steel
	Pomoli acciaio inox Stainless steel knobs					Acciaio Satinato Satin Stainless Steel
	AI 0181	20	20	24	11	Acciaio Lucido Bright Stainless Steel
						Acciaio Satinato Satin Stainless Steel
		24	24	29	12	Acciaio Lucido Bright Stainless Steel
						Acciaio Satinato Satin Stainless Steel
						Acciaio Lucido Bright Stainless Steel

Maniglie acciaio inox
Stainless steel handles

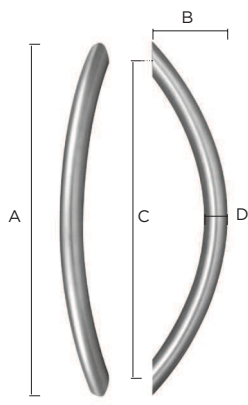

AI 0450

96	117	27	96	10	Acciaio Satinato Satin Stainless Steel
					Acciaio Lucido Bright Stainless Steel
128	150	30	128	10	Acciaio Satinato Satin Stainless Steel
					Acciaio Lucido Bright Stainless Steel
160	183	35	160	10	Acciaio Satinato Satin Stainless Steel
					Acciaio Lucido Bright Stainless Steel
192	222	35	192	10	Acciaio Satinato Satin Stainless Steel
					Acciaio Lucido Bright Stainless Steel
224	258	35	224	10	Acciaio Satinato Satin Stainless Steel
					Acciaio Lucido Bright Stainless Steel
320	370	35	320	10	Acciaio Satinato Satin Stainless Steel
					Acciaio Lucido Bright Stainless Steel

Maniglie acciaio inox
Stainless steel handles

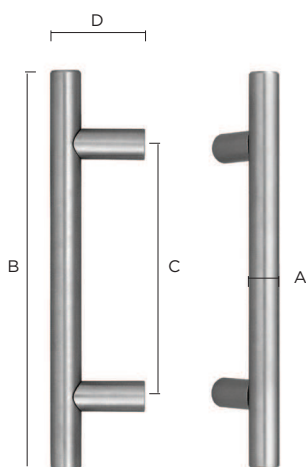

AI 0464 S

96	12	176	96	35	Acciaio Satinato Satin Stainless Steel
					Acciaio Lucido Bright Stainless Steel
128	12	208	128	35	Acciaio Satinato Satin Stainless Steel
					Acciaio Lucido Bright Stainless Steel
160	12	240	160	35	Acciaio Satinato Satin Stainless Steel
					Acciaio Lucido Bright Stainless Steel
190	12	272	190	35	Acciaio Satinato Satin Stainless Steel
					Acciaio Lucido Bright Stainless Steel
224	12	304	224	35	Acciaio Satinato Satin Stainless Steel
					Acciaio Lucido Bright Stainless Steel
320	12	400	320	35	Acciaio Satinato Satin Stainless Steel
					Acciaio Lucido Bright Stainless Steel



Maniglie acciaio inox
Stainless steel handles

352

12

432

352

35

Acciaio Satinato
Satin Stainless Steel

Acciaio Lucido
Bright Stainless Steel

416

12

496

416

35

Acciaio Satinato
Satin Stainless Steel

Acciaio Lucido
Bright Stainless Steel

448

12

528

448

35

Acciaio Satinato
Satin Stainless Steel

Acciaio Lucido
Bright Stainless Steel

480

12

560

480

35

Acciaio Satinato
Satin Stainless Steel

Acciaio Lucido
Bright Stainless Steel

640

12

720

640

35

Acciaio Satinato
Satin Stainless Steel

Acciaio Lucido
Bright Stainless Steel

736

12

816

736

35

Acciaio Satinato
Satin Stainless Steel

Acciaio Lucido
Bright Stainless Steel

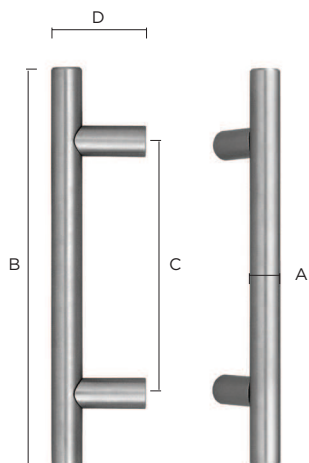

AI 0464 S

Maniglie acciaio inox
Stainless steel handles

160

16

200

160

40

Acciaio Satinato
Satin Stainless Steel

Acciaio Lucido
Bright Stainless Steel

192

16

232

192

40

Acciaio Satinato
Satin Stainless Steel

Acciaio Lucido
Bright Stainless Steel

256

16

296

256

40

Acciaio Satinato
Satin Stainless Steel

Acciaio Lucido
Bright Stainless Steel

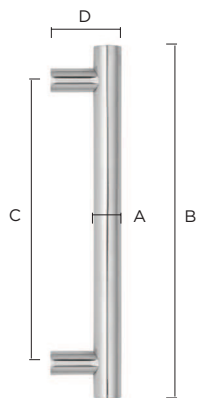

AI 0464 V

Maniglie acciaio inox
Stainless steel handles

96 10 116 96 32

Acciaio Satinato
Satin Stainless Steel

Acciaio Lucido
Bright Stainless Steel

128 10 148 128 32

Acciaio Satinato
Satin Stainless Steel

Acciaio Lucido
Bright Stainless Steel

160 10 180 160 32

Acciaio Satinato
Satin Stainless Steel

Acciaio Lucido
Bright Stainless Steel

192 10 212 192 32

Acciaio Satinato
Satin Stainless Steel

Acciaio Lucido
Bright Stainless Steel

AI 0466

224 10 244 224 32

Acciaio Satinato
Satin Stainless Steel

Acciaio Lucido
Bright Stainless Steel

320 10 340 320 32

Acciaio Satinato
Satin Stainless Steel

Acciaio Lucido
Bright Stainless Steel

480 10 500 480 32

Acciaio Satinato
Satin Stainless Steel

Acciaio Lucido
Bright Stainless Steel

640 10 660 640 32

Acciaio Satinato
Satin Stainless Steel

Acciaio Lucido
Bright Stainless Steel

736 10 756 736 32

Acciaio Satinato
Satin Stainless Steel

Acciaio Lucido
Bright Stainless Steel

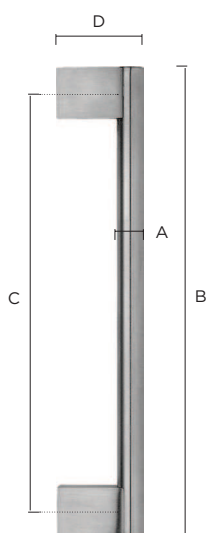

Maniglie acciaio inox
Stainless steel handles

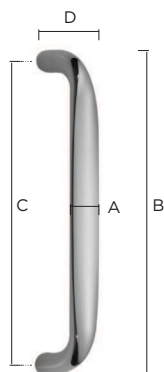

AI 0470

96 16 106 96 23

Acciaio Satinato
Satin Stainless Steel

Acciaio Lucido
Bright Stainless Steel

128 16 138 128 23

Acciaio Satinato
Satin Stainless Steel

Acciaio Lucido
Bright Stainless Steel

160 20 172 160 28

Acciaio Satinato
Satin Stainless Steel

Acciaio Lucido
Bright Stainless Steel

192 20 204 192 28

Acciaio Satinato
Satin Stainless Steel

Acciaio Lucido
Bright Stainless Steel

320 20 332 320 28

Acciaio Satinato
Satin Stainless Steel

Acciaio Lucido
Bright Stainless Steel

Maniglie acciaio inox
Stainless steel handles

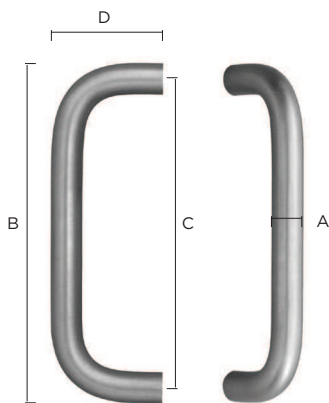

AI 0537

96 8 104 96 30

Acciaio Satinato
Satin Stainless Steel

Acciaio Lucido
Bright Stainless Steel

128 8 136 128 30

Acciaio Satinato
Satin Stainless Steel

Acciaio Lucido
Bright Stainless Steel

160 8 168 160 30

Acciaio Satinato
Satin Stainless Steel

Acciaio Lucido
Bright Stainless Steel

Maniglie acciaio inox
Stainless steel handles

192

8

200

192

30

Acciaio Satinato
Satin Stainless Steel

Acciaio Lucido
Bright Stainless Steel

256

8

264

256

30

Acciaio Satinato
Satin Stainless Steel

Acciaio Lucido
Bright Stainless Steel

96

10

106

96

35

Acciaio Satinato
Satin Stainless Steel

Acciaio Lucido
Bright Stainless Steel

128

10

138

128

35

Acciaio Satinato
Satin Stainless Steel

Acciaio Lucido
Bright Stainless Steel

160

10

170

160

35

Acciaio Satinato
Satin Stainless Steel

Acciaio Lucido
Bright Stainless Steel

192

10

202

192

35

Acciaio Satinato
Satin Stainless Steel

Acciaio Lucido
Bright Stainless Steel

320

10

330

320

35

Acciaio Satinato
Satin Stainless Steel

Acciaio Lucido
Bright Stainless Steel

480

10

490

480



35

Acciaio Satinato
Satin Stainless Steel

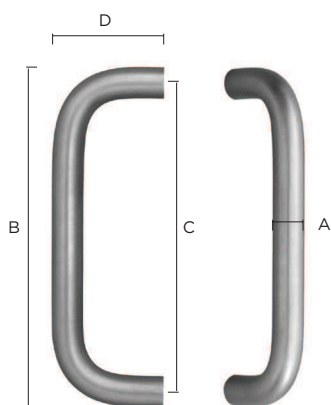
Acciaio Lucido
Bright Stainless Steel

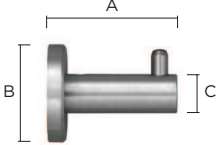

AI 0537

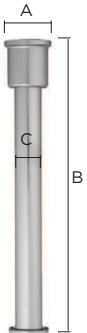
	Articolo Item	Misure Sizes				Finitura Finish
		A	B	C	D	
	Appendiabiti Coat Hangers AI 1542	14	35	46	14	Acciaio Satinato Satin Stainless Steel
						Acciaio Lucido Bright Stainless Steel
	Reggipensili Wall Brackets	1000	35	900	20	Acciaio Satinato Satin Stainless Steel
	AI 2025					Acciaio Lucido Bright Stainless Steel
		1200	35	1115	20	Acciaio Satinato Satin Stainless Steel
						Acciaio Lucido Bright Stainless Steel

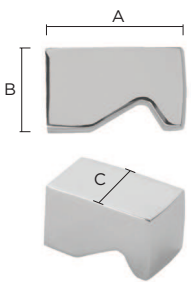
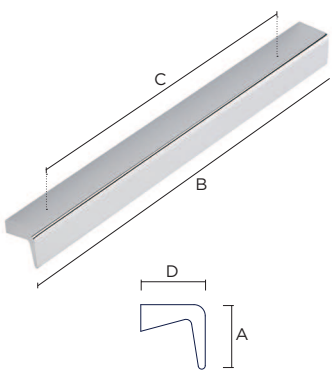

.....
ALLUMINIO
ALUMINIUM

Articolo Item	Misure Sizes				Finitura Finish		
	A	B	C	D			
<p>Pomolo alluminio per mobile Aluminium cabinet knob</p>  <p>AL 0192</p>	15	22	15	15	<p>Alluminio Anodizzato Anodised Aluminium</p> <hr/> <p>Alluminio Cromato Chrome Aluminium</p> <hr/> <p>Alluminio Anodizzato Inox Inox Anodised Aluminium</p>		
	20	30	20	20	<p>Alluminio Anodizzato Anodised Aluminium</p> <hr/> <p>Alluminio Cromato Chrome Aluminium</p> <hr/> <p>Alluminio Anodizzato Inox Inox Anodised Aluminium</p>		
	<hr/>						
	<p>Maniglie alluminio per mobile Aluminium cabinet handles</p>  <p>AL 0400</p>	160	23	240	160	23	<p>Alluminio Anodizzato Anodised Aluminium</p> <hr/> <p>Alluminio Cromato Chrome Aluminium</p> <hr/> <p>Alluminio Anodizzato Inox Inox Anodised Aluminium</p>
		320	23	390	320	23	<p>Alluminio Anodizzato Anodised Aluminium</p> <hr/> <p>Alluminio Cromato Chrome Aluminium</p> <hr/> <p>Alluminio Anodizzato Inox Inox Anodised Aluminium</p>
		<hr/>					
448		23	540	448	23	<p>Alluminio Anodizzato Anodised Aluminium</p> <hr/> <p>Alluminio Cromato Chrome Aluminium</p> <hr/> <p>Alluminio Anodizzato Inox Inox Anodised Aluminium</p>	
640		23	740	640	23	<p>Alluminio Anodizzato Anodised Aluminium</p> <hr/> <p>Alluminio Cromato Chrome Aluminium</p> <hr/> <p>Alluminio Anodizzato Inox Inox Anodised Aluminium</p>	
736		23	840	736	23	<p>Alluminio Anodizzato Anodised Aluminium</p> <hr/> <p>Alluminio Cromato Chrome Aluminium</p> <hr/> <p>Alluminio Anodizzato Inox Inox Anodised Aluminium</p>	

Articolo
Item

Misure
Sizes

Finitura
Finish

A

B

C

D

Maniglie alluminio
per mobile
Aluminium cabinet
handles

160

23

240

23

Alluminio Anodizzato
Anodised Aluminium

Alluminio Cromato
Chrome Aluminium

Alluminio Anodizzato Inox
Inox Anodised Aluminium

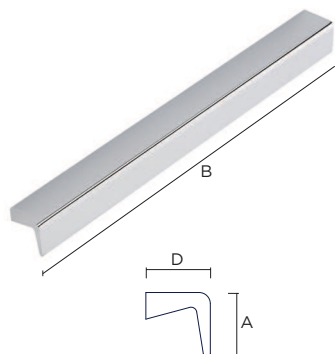

AL 0400 V

320

23

390

23

Alluminio Anodizzato
Anodised Aluminium

Alluminio Cromato
Chrome Aluminium

Alluminio Anodizzato Inox
Inox Anodised Aluminium

448

23

540

23

Alluminio Anodizzato
Anodised Aluminium

Alluminio Cromato
Chrome Aluminium

Alluminio Anodizzato Inox
Inox Anodised Aluminium

Maniglie alluminio
per mobile
Aluminium cabinet
handles

160

16

240

160

21

Alluminio Anodizzato
Anodised Aluminium

Alluminio Cromato
Chrome Aluminium

Alluminio Anodizzato Inox
Inox Anodised Aluminium

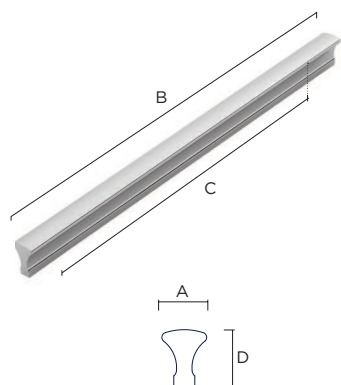

AL 0401

320

16

390

320

21

Alluminio Anodizzato
Anodised Aluminium

Alluminio Cromato
Chrome Aluminium

Alluminio Anodizzato Inox
Inox Anodised Aluminium

448

16

540

448

21

Alluminio Anodizzato
Anodised Aluminium

Alluminio Cromato
Chrome Aluminium

Alluminio Anodizzato Inox
Inox Anodised Aluminium

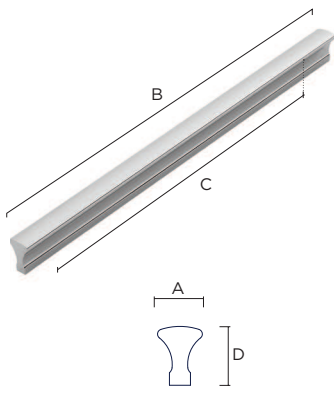
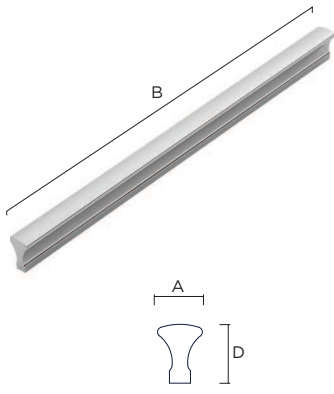
Articolo Item	Misure Sizes				Finitura Finish		
	A	B	C	D			
<p>Maniglie alluminio per mobile Aluminium cabinet handles</p>  <p>AL 0401</p>	640	16	740	640	21	Alluminio Anodizzato Anodised Aluminium	
							Alluminio Cromato Chrome Aluminium
							Alluminio Anodizzato Inox Inox Anodised Aluminium
							Alluminio Anodizzato Anodised Aluminium
		736	16	840	736	12	Alluminio Cromato Chrome Aluminium
							Alluminio Anodizzato Inox Inox Anodised Aluminium
<p>Maniglie alluminio per mobile Aluminium cabinet handles</p>  <p>AL 0401 V</p>	160	16	240		21	Alluminio Anodizzato Anodised Aluminium	
							Alluminio Cromato Chrome Aluminium
							Alluminio Anodizzato Inox Inox Anodised Aluminium
							Alluminio Anodizzato Anodised Aluminium
		320	16	390		21	Alluminio Cromato Chrome Aluminium
							Alluminio Anodizzato Inox Inox Anodised Aluminium
						Alluminio Anodizzato Anodised Aluminium	
	448	16	540		21	Alluminio Cromato Chrome Aluminium	
						Alluminio Anodizzato Inox Inox Anodised Aluminium	

Maniglie alluminio
per mobile
Aluminium cabinet
handles

Alluminio Anodizzato
Anodised Aluminium

160 35 230 160 27

Alluminio Cromato
Chrome Aluminium

Alluminio Anodizzato Inox
Inox Anodised Aluminium

Alluminio Anodizzato
Anodised Aluminium

320 35 380 320 27

Alluminio Cromato
Chrome Aluminium

Alluminio Anodizzato Inox
Inox Anodised Aluminium

Alluminio Anodizzato
Anodised Aluminium

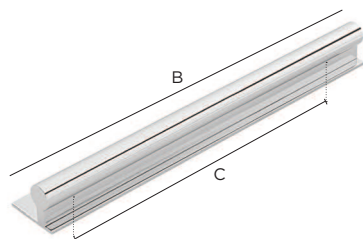

AL 0404

448 35 530 448 27

Alluminio Cromato
Chrome Aluminium

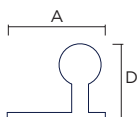

Alluminio Anodizzato Inox
Inox Anodised Aluminium

Alluminio Anodizzato
Anodised Aluminium

640 35 730 640 27

Alluminio Cromato
Chrome Aluminium

Alluminio Anodizzato Inox
Inox Anodised Aluminium

Alluminio Anodizzato
Anodised Aluminium

736 35 830 736 27

Alluminio Cromato
Chrome Aluminium

Alluminio Anodizzato Inox
Inox Anodised Aluminium

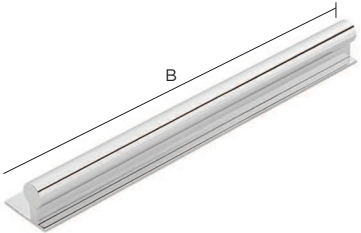
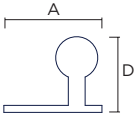
Articolo Item	Misure Sizes				Finitura Finish
	A	B	C	D	
<p>Maniglie alluminio per mobile Aluminium cabinet handles</p>  <p>AL 0404 V</p> 	160	35	230	27	<p>Alluminio Anodizzato Anodised Aluminium</p> <hr/> <p>Alluminio Cromato Chrome Aluminium</p> <hr/> <p>Alluminio Anodizzato Inox Inox Anodised Aluminium</p>
	320	35	380	27	<p>Alluminio Anodizzato Anodised Aluminium</p> <hr/> <p>Alluminio Cromato Chrome Aluminium</p> <hr/> <p>Alluminio Anodizzato Inox Inox Anodised Aluminium</p>
	448	35	530	27	<p>Alluminio Anodizzato Anodised Aluminium</p> <hr/> <p>Alluminio Cromato Chrome Aluminium</p> <hr/> <p>Alluminio Anodizzato Inox Inox Anodised Aluminium</p>

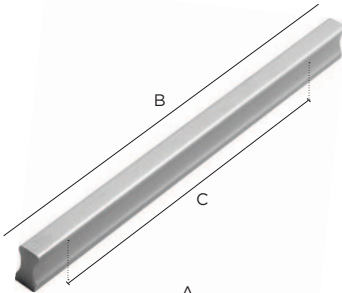
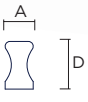
<p>Maniglie alluminio per mobile Aluminium cabinet handles</p>  <p>AL 0408</p> 	160	10	260	160	17	<p>Alluminio Anodizzato Anodised Aluminium</p> <hr/> <p>Alluminio Cromato Chrome Aluminium</p> <hr/> <p>Alluminio Anodizzato Inox Inox Anodised Aluminium</p>
	320	10	410	320	17	<p>Alluminio Anodizzato Anodised Aluminium</p> <hr/> <p>Alluminio Cromato Chrome Aluminium</p> <hr/> <p>Alluminio Anodizzato Inox Inox Anodised Aluminium</p>

Articolo
Item

Misure
Sizes

Finitura
Finish

A B C D

Maniglie alluminio
per mobile
Aluminium cabinet
handles

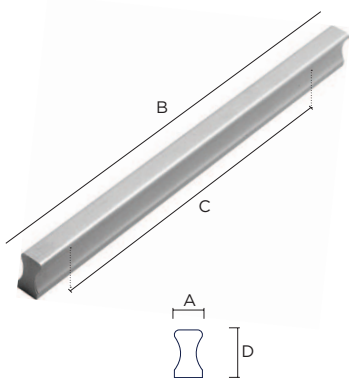

AL 0408

Articolo Item	Misure Sizes				Finitura Finish
	A	B	C	D	
448	10	560	448	17	Alluminio Anodizzato Anodised Aluminium
					Alluminio Cromato Chrome Aluminium
					Alluminio Anodizzato Inox Inox Anodised Aluminium
640	10	760	640	17	Alluminio Anodizzato Anodised Aluminium
					Alluminio Cromato Chrome Aluminium
					Alluminio Anodizzato Inox Inox Anodised Aluminium
736	10	860	736	17	Alluminio Anodizzato Anodised Aluminium
					Alluminio Cromato Chrome Aluminium
					Alluminio Anodizzato Inox Inox Anodised Aluminium

Maniglie alluminio
per mobile
Aluminium cabinet
handles

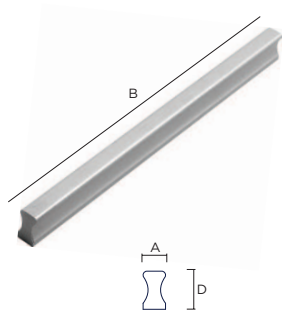

AL 0408 V

Articolo Item	Misure Sizes				Finitura Finish
	A	B	C	D	
160	10	260		17	Alluminio Anodizzato Anodised Aluminium
					Alluminio Cromato Chrome Aluminium
					Alluminio Anodizzato Inox Inox Anodised Aluminium
320	10	410		17	Alluminio Anodizzato Anodised Aluminium
					Alluminio Cromato Chrome Aluminium
					Alluminio Anodizzato Inox Inox Anodised Aluminium
448	10	560		17	Alluminio Anodizzato Anodised Aluminium
					Alluminio Cromato Chrome Aluminium
					Alluminio Anodizzato Inox Inox Anodised Aluminium

Maniglie alluminio
per mobile
Aluminium cabinet
handles

128

16

140

128

36

Alluminio Anodizzato
Anodised Aluminium

Alluminio Cromato
Chrome Aluminium

Alluminio Anodizzato Inox
Inox Anodised Aluminium

160

16

172

160

36

Alluminio Anodizzato
Anodised Aluminium

Alluminio Cromato
Chrome Aluminium

Alluminio Anodizzato Inox
Inox Anodised Aluminium

192

16

204

192

36

Alluminio Anodizzato
Anodised Aluminium

Alluminio Cromato
Chrome Aluminium

Alluminio Anodizzato Inox
Inox Anodised Aluminium

AL 0409

224

16

236

224

36

Alluminio Anodizzato
Anodised Aluminium

Alluminio Cromato
Chrome Aluminium

Alluminio Anodizzato Inox
Inox Anodised Aluminium

256

16

268

256

36

Alluminio Anodizzato
Anodised Aluminium

Alluminio Cromato
Chrome Aluminium

Alluminio Anodizzato Inox
Inox Anodised Aluminium

320

16

332

320

36

Alluminio Anodizzato
Anodised Aluminium

Alluminio Cromato
Chrome Aluminium

Alluminio Anodizzato Inox
Inox Anodised Aluminium

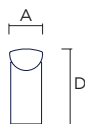
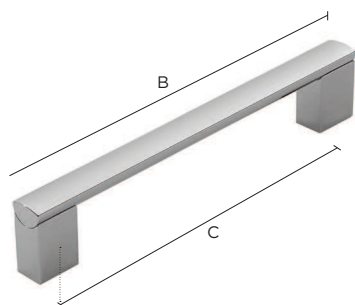

Articolo
Item

Misure
Sizes

Finitura
Finish

A

B

C

D

Maniglie alluminio
per mobile
Aluminium cabinet
handles

Alluminio Anodizzato
Anodised Aluminium

352 16 364 352 36

Alluminio Cromato
Chrome Aluminium

Alluminio Anodizzato Inox
Inox Anodised Aluminium

Alluminio Anodizzato
Anodised Aluminium

448 16 460 448 36

Alluminio Cromato
Chrome Aluminium

Alluminio Anodizzato Inox
Inox Anodised Aluminium

Alluminio Anodizzato
Anodised Aluminium

512 16 524 512 36

Alluminio Cromato
Chrome Aluminium

Alluminio Anodizzato Inox
Inox Anodised Aluminium

Alluminio Anodizzato
Anodised Aluminium

640 16 652 640 36

Alluminio Cromato
Chrome Aluminium

Alluminio Anodizzato Inox
Inox Anodised Aluminium

Alluminio Anodizzato
Anodised Aluminium

800 16 812 800 36

Alluminio Cromato
Chrome Aluminium

Alluminio Anodizzato Inox
Inox Anodised Aluminium

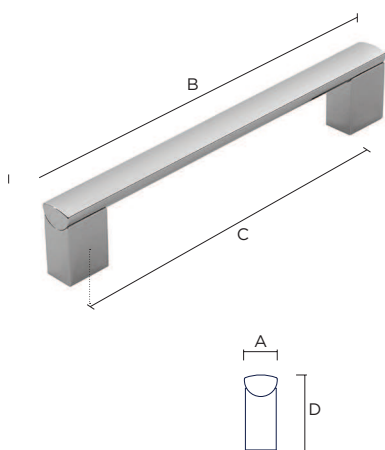

AL 0409

Maniglie alluminio
per mobile
Aluminium cabinet
handles

160

14

174

160

38

Alluminio Anodizzato
Anodised Aluminium

Alluminio Cromato
Chrome Aluminium

Alluminio Anodizzato Inox
Inox Anodised Aluminium

192

14

206

192

38

Alluminio Anodizzato
Anodised Aluminium

Alluminio Cromato
Chrome Aluminium

Alluminio Anodizzato Inox
Inox Anodised Aluminium

320

14

334

320

38

Alluminio Anodizzato
Anodised Aluminium

Alluminio Cromato
Chrome Aluminium

Alluminio Anodizzato Inox
Inox Anodised Aluminium

AL 0410

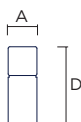
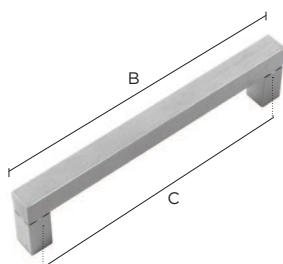

448

14

462

448

38

Alluminio Anodizzato
Anodised Aluminium

Alluminio Cromato
Chrome Aluminium

Alluminio Anodizzato Inox
Inox Anodised Aluminium

640

14

654

640

38

Alluminio Anodizzato
Anodised Aluminium

Alluminio Cromato
Chrome Aluminium

Alluminio Anodizzato Inox
Inox Anodised Aluminium

736

14

750

736

38

Alluminio Anodizzato
Anodised Aluminium

Alluminio Cromato
Chrome Aluminium

Alluminio Anodizzato Inox
Inox Anodised Aluminium

Articolo
Item

Misure
Sizes

Finitura
Finish

A

B

C

D

Maniglie alluminio
per mobile
Aluminium cabinet
handles

Alluminio Anodizzato
Anodised Aluminium

160 14 174 38

Alluminio Cromato
Chrome Aluminium

Alluminio Anodizzato Inox
Inox Anodised Aluminium

Alluminio Anodizzato
Anodised Aluminium

192 14 206 38

Alluminio Cromato
Chrome Aluminium

Alluminio Anodizzato Inox
Inox Anodised Aluminium

Alluminio Anodizzato
Anodised Aluminium

320 14 334 38

Alluminio Cromato
Chrome Aluminium

Alluminio Anodizzato Inox
Inox Anodised Aluminium

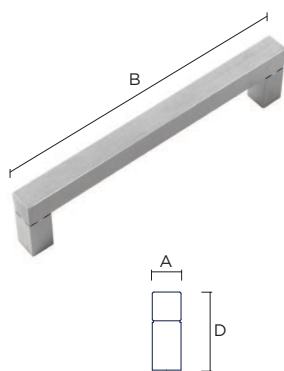

AL 0410 V

Maniglie alluminio
per mobile
Aluminium cabinet
handles

Alluminio Anodizzato
Anodised Aluminium

160 174 30 160 39

Alluminio Cromato
Chrome Aluminium

Alluminio Anodizzato Inox
Inox Anodised Aluminium

Alluminio Anodizzato
Anodised Aluminium

224 238 30 244 39

Alluminio Cromato
Chrome Aluminium

Alluminio Anodizzato Inox
Inox Anodised Aluminium

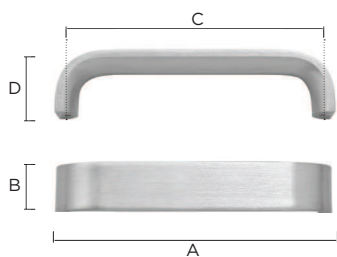

AL 0411

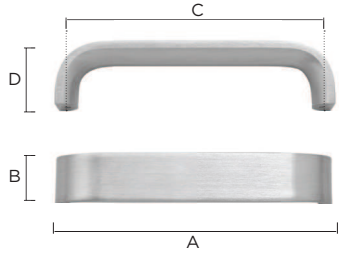
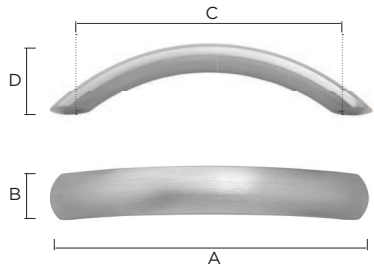

	Articolo Item	Misure Sizes				Finitura Finish		
		A	B	C	D			
	<p>Maniglie alluminio per mobile Aluminium cabinet handles</p> <p>AL 0411</p>	320	334	30	320	39	Alluminio Anodizzato Anodised Aluminium	
								Alluminio Cromato Chrome Aluminium
								Alluminio Anodizzato Inox Inox Anodised Aluminium
								Alluminio Anodizzato Anodised Aluminium
								Alluminio Cromato Chrome Aluminium
								Alluminio Anodizzato Inox Inox Anodised Aluminium
	<p>Maniglie alluminio per mobile Aluminium cabinet handles</p> <p>AL 0412</p>	160	195	28	160	41	Alluminio Anodizzato Anodised Aluminium	
								Alluminio Cromato Chrome Aluminium
								Alluminio Anodizzato Inox Inox Anodised Aluminium
								Alluminio Anodizzato Anodised Aluminium
								Alluminio Cromato Chrome Aluminium
								Alluminio Anodizzato Inox Inox Anodised Aluminium
								Alluminio Anodizzato Anodised Aluminium
								Alluminio Cromato Chrome Aluminium
								Alluminio Anodizzato Inox Inox Anodised Aluminium
								Alluminio Anodizzato Anodised Aluminium
								Alluminio Cromato Chrome Aluminium
								Alluminio Anodizzato Inox Inox Anodised Aluminium

Maniglie alluminio
per mobile
Aluminium cabinet
handles

AL 0413

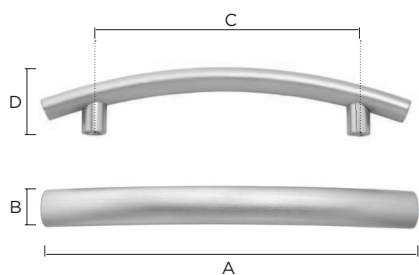

160 225 22 160 41 Alluminio Anodizzato
Anodised Aluminium

Alluminio Cromato
Chrome Aluminium

Alluminio Anodizzato Inox
Inox Anodised Aluminium

Alluminio Anodizzato
Anodised Aluminium

224 308 22 244 42 Alluminio Cromato
Chrome Aluminium

Alluminio Anodizzato Inox
Inox Anodised Aluminium

Alluminio Anodizzato
Anodised Aluminium

320 383 22 320 42 Alluminio Cromato
Chrome Aluminium

Alluminio Anodizzato Inox
Inox Anodised Aluminium

Alluminio Anodizzato
Anodised Aluminium

640 702 22 640 45 Alluminio Cromato
Chrome Aluminium

Alluminio Anodizzato Inox
Inox Anodised Aluminium

Alluminio Anodizzato
Anodised Aluminium

800 861 22 800 45 Alluminio Cromato
Chrome Aluminium

Alluminio Anodizzato Inox
Inox Anodised Aluminium

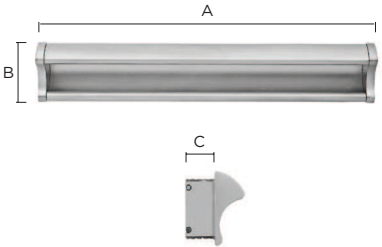
Articolo Item	Misure Sizes				Finitura Finish
	A	B	C	D	
<p>Maniglie alluminio per mobile Aluminium cabinet handles</p>  <p>AL 0599</p>	128	36	14	Alluminio Anodizzato Anodised Aluminium	
	128	36	14	Alluminio Anodizzato Inox Inox Anodised Aluminium	
	160	36	14	Alluminio Anodizzato Anodised Aluminium	
	160	36	14	Alluminio Anodizzato Inox Inox Anodised Aluminium	
	200	36	14	Alluminio Anodizzato Anodised Aluminium	
	200	36	14	Alluminio Anodizzato Inox Inox Anodised Aluminium	



FISSAGGIO BIADESIVO

Il sistema biadesivo 3M è l'alternativa a rivetti e viti per le maniglie in alluminio AL 0400 V, AL 0401 V, AL 0404 V e AL 0408 V.

Caratteristiche del fissaggio biadesivo:

- Non richiede forature, saldature, rettifiche o rifiniture.
- Ha eccellenti proprietà sigillanti con smorzamento delle vibrazioni e compensazione dei diversi coefficienti di dilatazione termica dei materiali.
- Mantiene inalterata la sua tenuta nel tempo.
- Resiste ai raggi UV ed ai detergenti chimici.
- Riduce i costi di montaggio poichè si utilizza facilmente anche senza l'intervento di un installatore.

PREPARAZIONE DELLE SUPERFICI

Per ottenere un'adesione ottimale occorre che la superficie dove verrà applicata la maniglia sia pulita con l'apposita salviettina (contenuta nel kit), asciutta e a temperatura ambiente (minimo 21°C - max 38°C).

Come solventi per la pulizia si possono usare anche eptano o alcool isopropilico più acqua.

Dopo aver tolto la linguetta protettiva posta sulla striscia biadesiva si effettua una decisa pressione tra maniglia e supporto.

Il 90% della tenuta si raggiunge dopo un giorno e trascorse 72 ore si ha l'assestamento definitivo.

Per aumentare ancora la presa in superfici a contatto con l'acqua è sufficiente riscaldare l'area a 70°C per circa un'ora.

DOUBLE-SIDED ADHESIVE

The 3M double-sided adhesive system is the alternative to rivets and screws for AL 0400 V, AL 0401 V, AL 0404 V and AL 0408 V aluminium handles.

Features of the double-sided tape:

- Does not require drilling, welding, grinding or finishing touch.
- Offers excellent seal properties, reduces vibrations and compensates the different coefficients of thermal expansion of materials.
- Provides long-lasting tightness.
- Is resistant to UV rays and chemical cleaners.
- Reduces installation costs, as it is easy to use without requiring the help of a professional installer.

PREPARING THE SURFACES

To achieve optimal adhesion, clean the surface where the handle will be installed using the special cloth (provided in the kit). The surface should be at room temperature (min. 21°C, max 38°C). Heptane or an isopropyl alcohol and water mix can be used to clean the surface.

Remove the protective strip from the double-sided tape and apply firm pressure on the handle and support. 90% of adhesive bond strength will be achieved after one day and the final result will be achieved after 72 hours.

To further enhance adhesive bond strength on surfaces that may come into contact with water, heat the area to about 70°C for an hour.

pulire con solvente

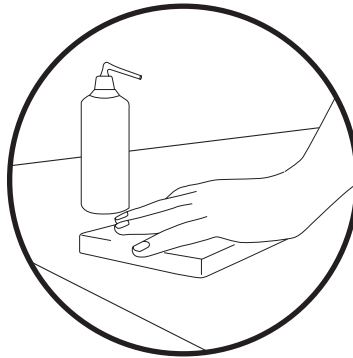

clean with solvent

asciugare con salviettina

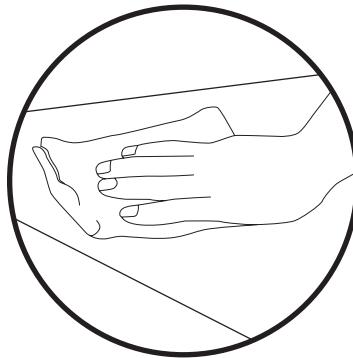

dry with a cloth

staccare pellicola protettiva e applicare

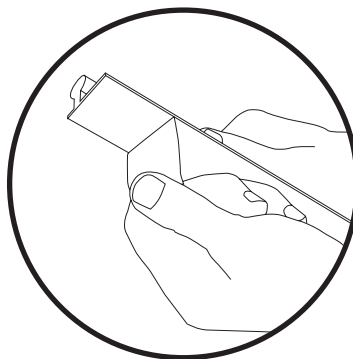

remove the protective film and apply

premere con forza

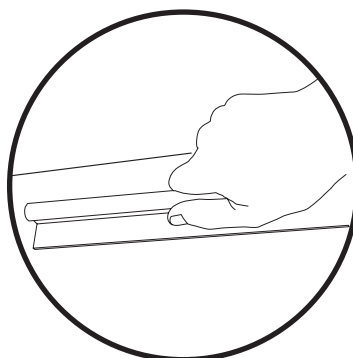

press firmly

..... FRESATURE INCASSO
..... MILLING CUTS

58050

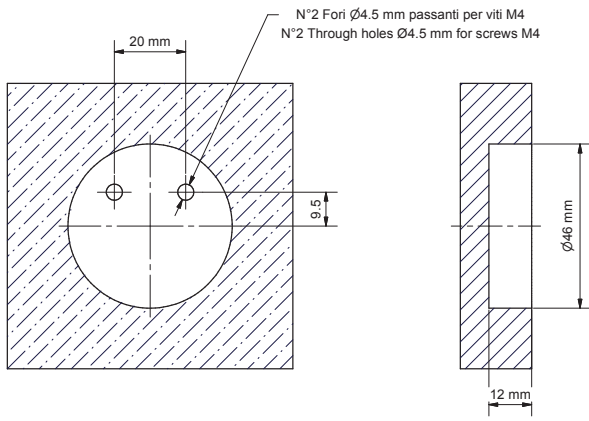

58740

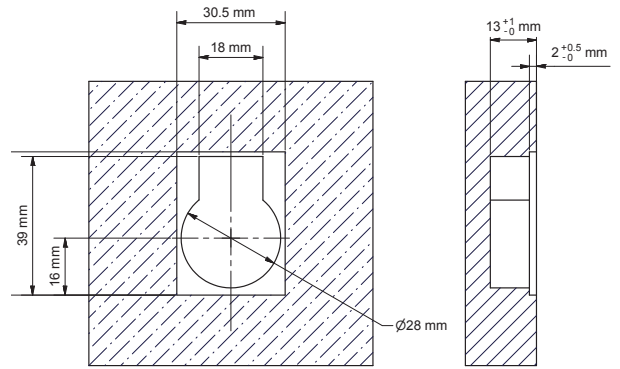

58750

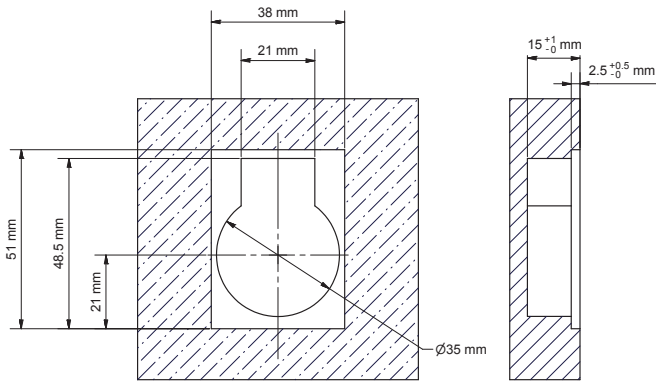

58760

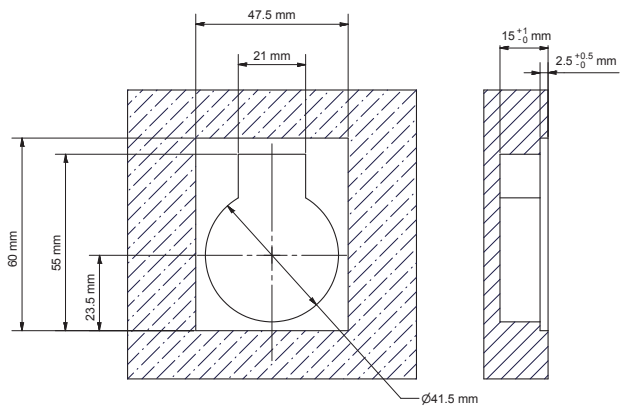

58740 BA

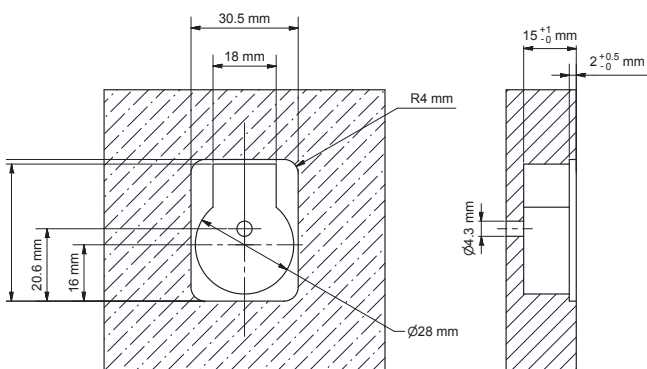

58750 BA

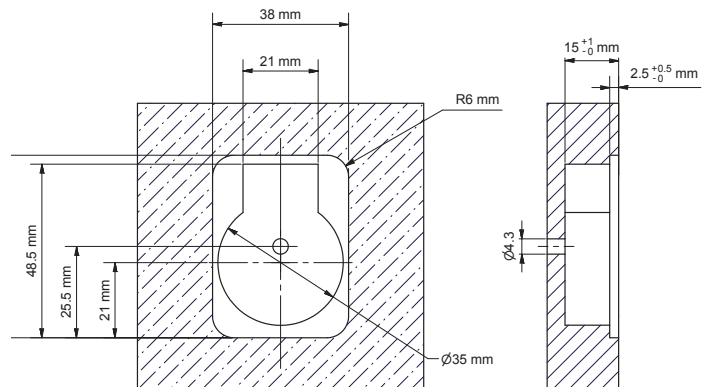

58760 BA

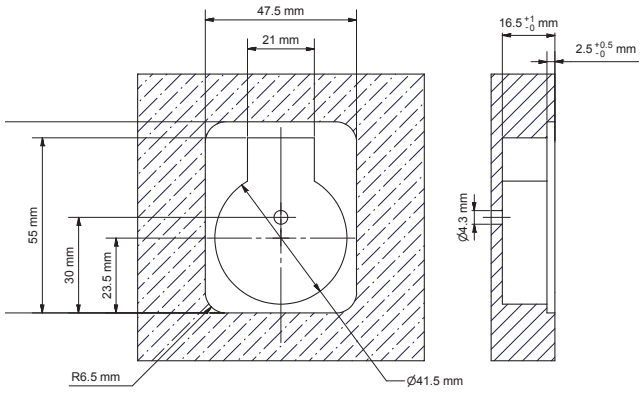

58860

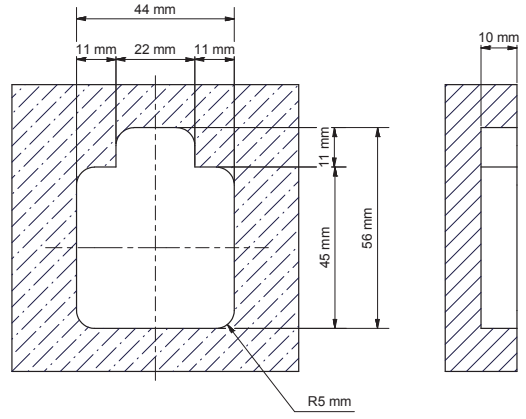

589 Kit Pull / 589AC Kit Pull

Sede Maniglia
Handle Housing

Sede Frontale-
Frontal Housing

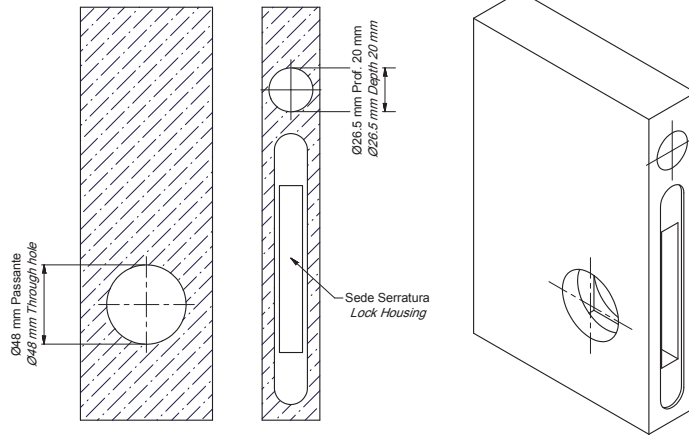

590 Kit Pull / 590AC Kit Pull

Sede Maniglia
Handle Housing

Sede Frontale
Frontal Housing

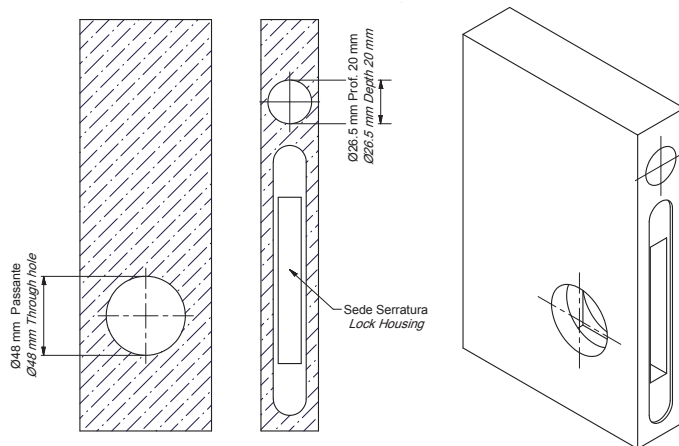

59250

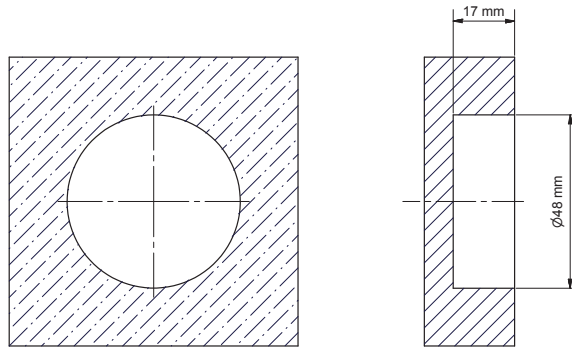

59250 Kit Pull

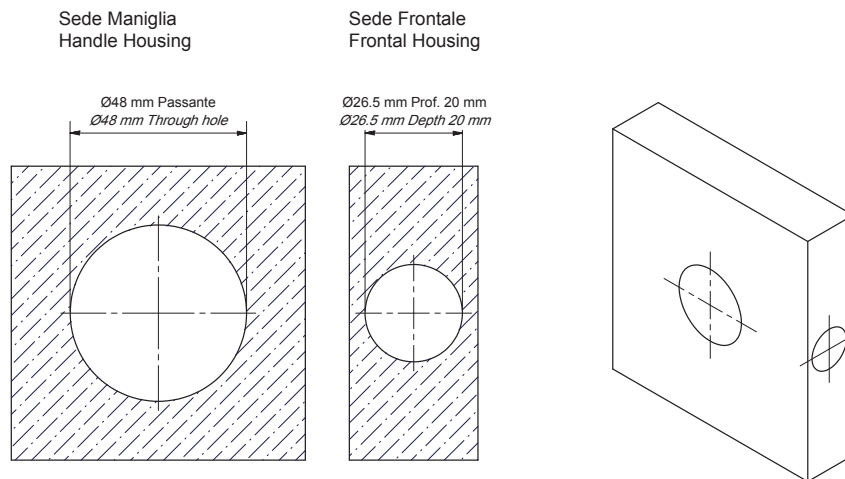

593 / 593 A / 593 A FC

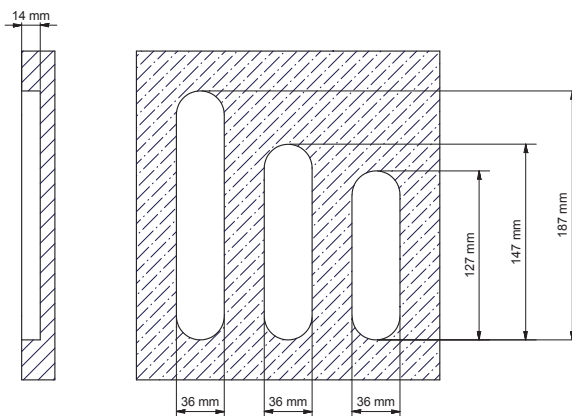

593 Kit Pull

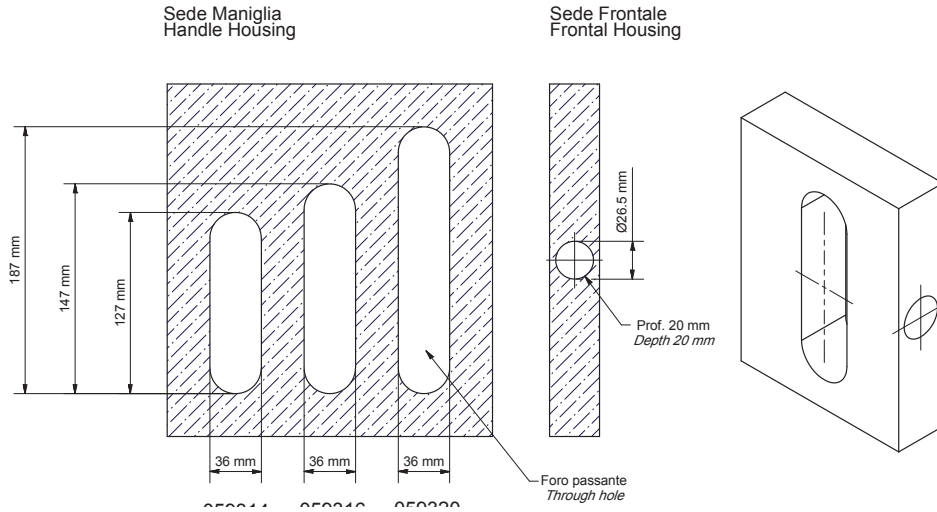

593 AC Kit Pull

594 Ditale / Pocket Door Finger Pull

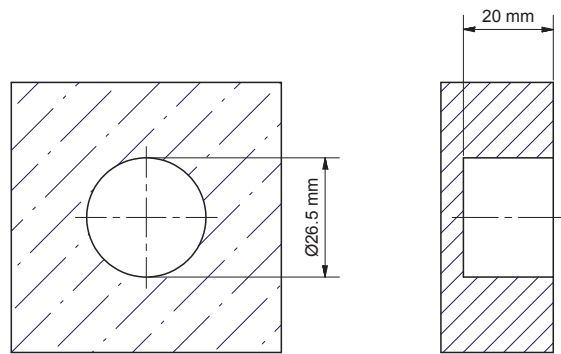
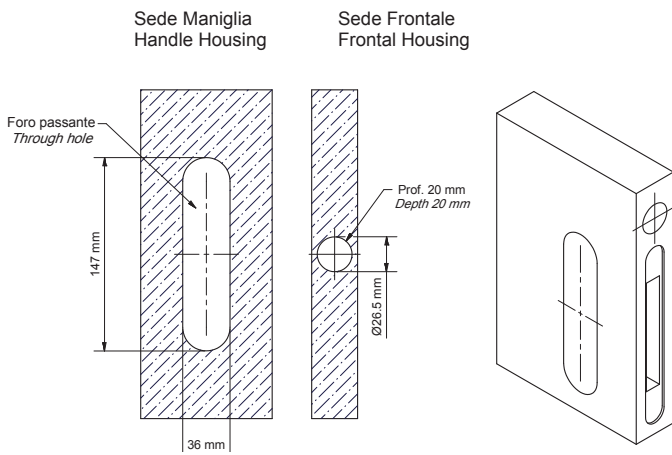

594 A / B / C

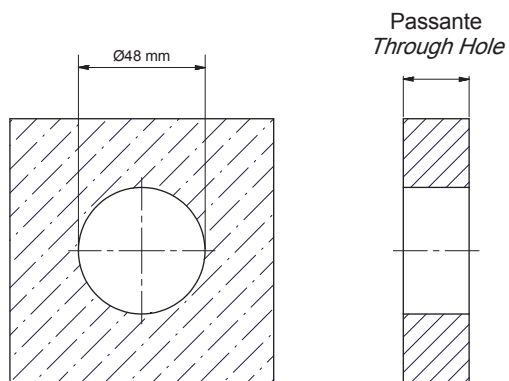

594 A Kit Pull

Sede Maniglia
Handle Housing

Sede Frontale
Frontal Housing

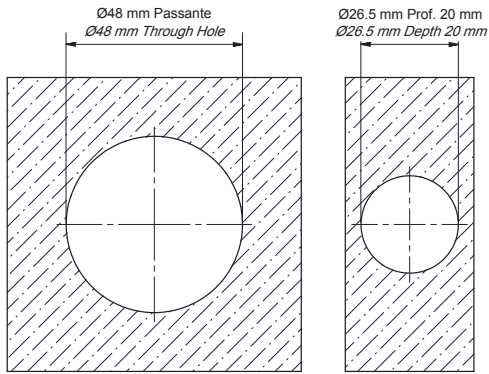

595

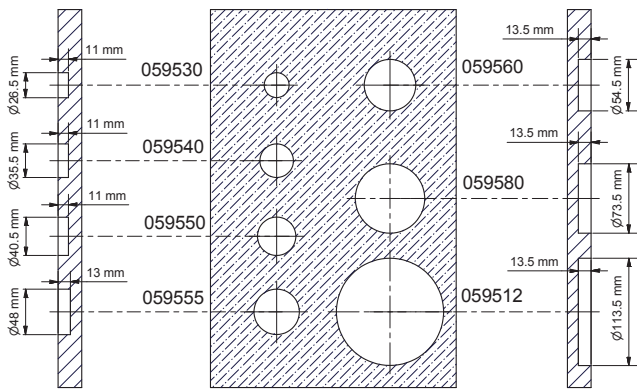

596

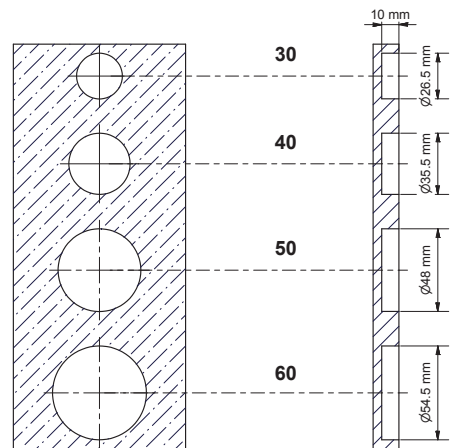

597 A / B / C

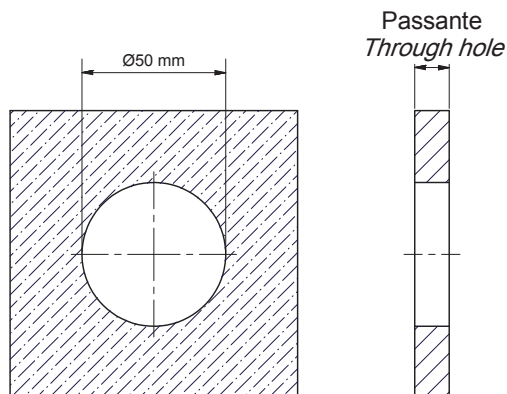

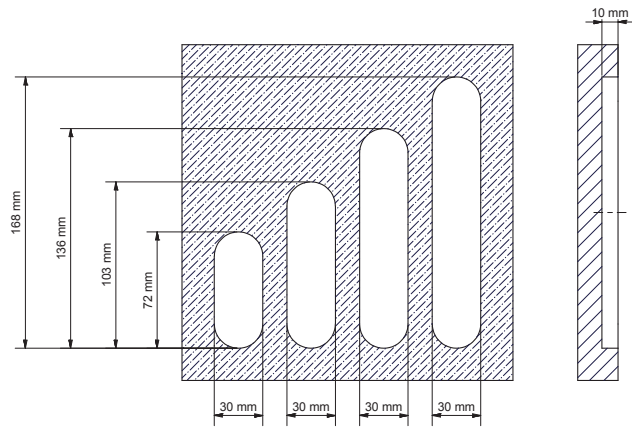

CONDIZIONI GENERALI DI VENDITA STANDARD TERMS OF SALE

PREMESSA

Salvo espressa deroga risultante da apposito atto scritto, ogni compravendita dei prodotti OMP PORRO S.r.l. è regolata dalle seguenti condizioni generali di vendita che costituiscono parte essenziale del contratto e che si intendono pertanto accettate dal Compratore ancorché dallo stesso non sottoscritte. Qualsiasi clausola unilaterale apposta dal Compratore nei documenti da lui sottoscritti e/o nella sua corrispondenza, che sia contraria o comunque in aggiunta alle seguenti condizioni generali od a quelle speciali espressamente approvate per iscritto dal Venditore, si intende come non scritta ed è priva di ogni effetto.

PREMISES

Unless otherwise agreed in writing, all sales of OMP PORRO S.r.l. products are regulated by the following standard terms of sale. These terms are integral part of the contract and are meant to be accepted by the Purchaser even if they haven't been signed by him. Any clause unilaterally specified by the Purchaser in the documents he has signed and/or in his correspondence, which may be against or in addition to the following standard terms or the special terms expressly approved in writing by the Seller, shall be deemed non-existent and void.

PERFEZIONAMENTO DEL CONTRATTO E PREZZI

La compravendita si intende perfezionata con la conferma scritta del Venditore o con inizio delle consegne. I prezzi concordati non comprendono prestazioni ed oneri accessori (quali IVA, spese di trasporto e così via). Per forniture continuative o consegne ripartite, il Venditore si riserva la facoltà di adeguare i prezzi concordati - con preavviso di trenta giorni - agli aumenti di costo delle materie prime, della mano d'opera e degli oneri fiscali che dovessero verificarsi nel corso della fornitura.

EXECUTION OF THE CONTRACT AND PRICES

The sale will be considered as accomplished when the Seller confirms in writing or when deliveries are started. Agreed prices are not inclusive of any additional charges or services (such as VAT, transport, etc.). In case of continuous supplies or partial shipments, the Seller reserves the right to adjust the agreed prices to the increases in cost of raw materials, labour and fiscal charges that might occur during the supply. A 30-day notice shall be given.

PATTO DI RISERVATO DOMINIO E RISOLUZIONE DEL CONTRATTO

Il Compratore acquista la proprietà della merce fornitagli solo con l'intero pagamento del prezzo - IVA compresa - e degli eventuali oneri e spese accessorie. Il rischio di perimento o deterioramento della merce tuttavia è a suo carico ed egli sarà tenuto a corrispondere l'intero prezzo. L'incompleto pagamento darà diritto al Venditore di richiedere la risoluzione del contratto e la restituzione della merce e quanto già pagato resterà acquisito al Venditore a titolo di indennità, salvo il diritto di richiedere il risarcimento per i maggiori danni.

RETENTION OF TITLE AND CANCELLATION OF THE CONTRACT

The Purchaser acquires the ownership of merchandise only after the entire payment of the price - VAT and additional expenses included. The risk of loss or damage to the merchandise is nevertheless at the expense of the Purchaser who will be obliged to pay the entire sum. The incomplete payment gives the Seller the right to demand the cancellation of the contract and the restitution of the merchandise. The downpayment remains as indemnity for the Seller who also has the right to claim for further damages.

CONDIZIONI GENERALI DI VENDITA STANDARD TERMS OF SALE

GARANZIA E DENUNCIA DI VIZI

Eventuali vizi o non conformità della merce devono essere segnalati dal Compratore al Venditore - sempre a pena di decadenza - entro otto giorni dal relativo ricevimento. La garanzia non opera ove i difetti rilevati siano imputabili a negligenza del Compratore, ovvero a circostanze che comunque non possono ricollegarsi a difetti di produzione.

GUARANTEE AND NOTICE OF DEFECTS

The Seller shall be notified by the Purchaser of any faults, latent defects or lack of compliance of the products within eight days from the receipt of goods, otherwise the claim will be void. The guarantee will not be effective if the faults found are ascribable to the Purchaser's carelessness or any other circumstances that cannot be ascribed to manufacturing defects due to the Seller.

OBBLIGHI DEL COMPRATORE

Il Compratore deve effettuare i pagamenti puntualmente, con le modalità e nei termini precisati in fattura. Sui ritardati pagamenti decorreranno gli interessi nella misura stabilita dalla Legge.

In caso di ritardo nei pagamenti il Venditore ha diritto di sospendere immediatamente ogni fornitura, anche se dipendente da altri contratti con lo stesso Compratore.

Il mancato pagamento nei termini pattuiti comporta in ogni caso la decadenza del Compratore dal beneficio del termine.

In caso di ritardato pagamento saranno addebitati gli interessi di mora previsti dal D. Lgs. n. 231 del 09/10/2002, pari al tasso della Banca Centrale Europea maggiorato di 7 punti percentuali.

PURCHASER'S OBLIGATIONS

The Purchaser shall carry out payments on time according to the terms and conditions stated on the invoice. Late payments will be charged of interests at the rate provided by law. In case of late payments, the Seller will be entitled to stop immediately any delivery even if related to other contracts with the same Purchaser. Failure of payments within the agreed time will in any case imply for the Purchaser the loss of the credit facilities that have been granted. In case of delayed payment we shall charge you the interests on arrears provided for by the Legislative Decree No. 231 dd. 09/10/2002, equal to the rate of the European Central Bank increased of 7 percentage points.

LEGGE APPLICABILE E FORO COMPETENTE

Il contratto è regolato dalla legge italiana. Per qualsiasi controversia inerente o conseguente alla compravendita è competente in via esclusiva l'Autorità Giudiziaria di Como.

APPLICABLE LAW AND JURISDICTION

This contract is governed by the Italian Law. Any controversy in connection with or arising out of a sale hereunder shall be referred to the Court of Como, Italy.

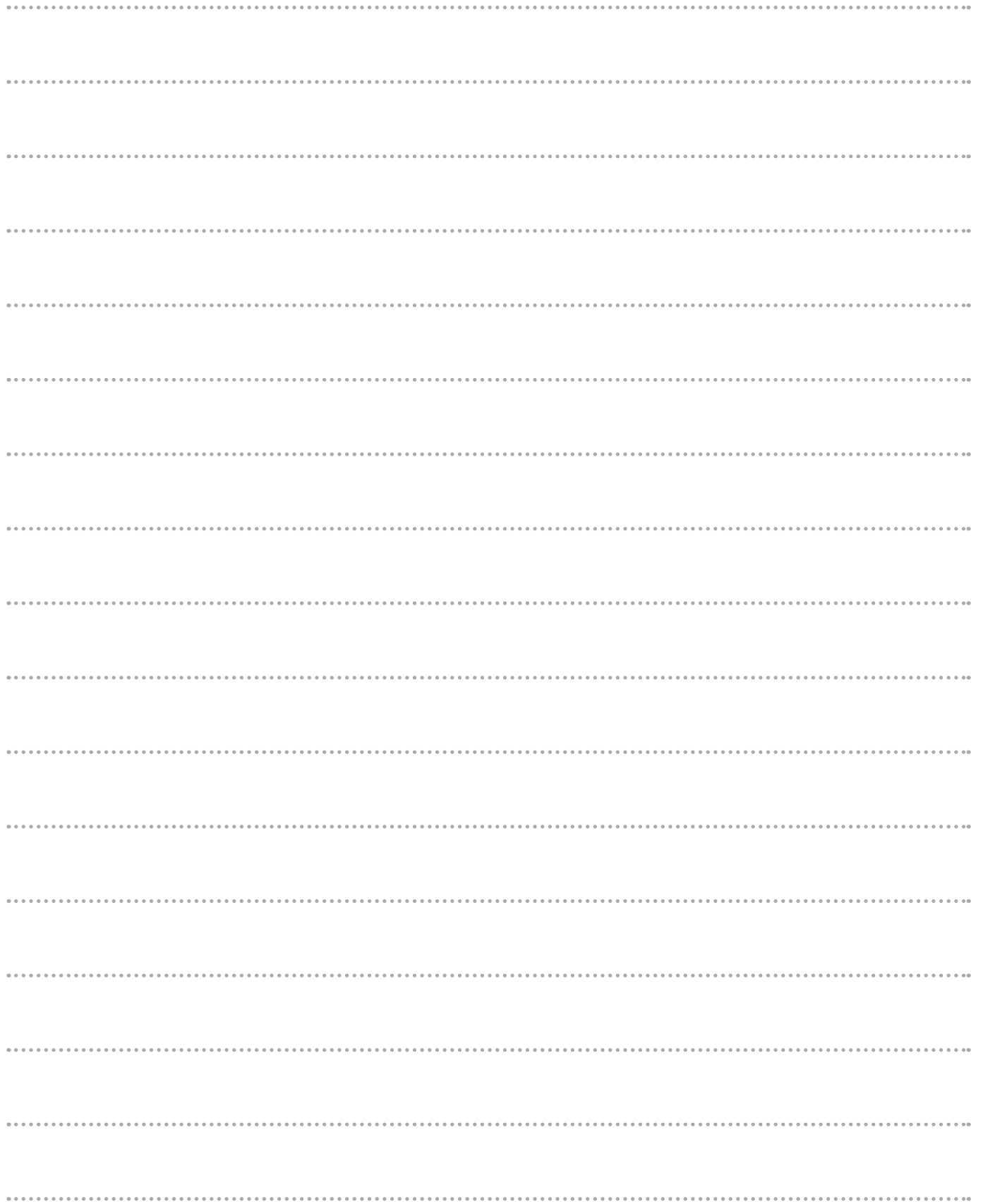

ALFREDO PORRO



MANUFACTURED BY OFFICINE MECCANICHE PORRO

omporro 

officine meccaniche porro

OMP PORRO S.r.l

22060 Cucciago (CO) ITALY - via Stazione, 8/a
tel. +39 031.787100 r.a. - fax +39 031.787575

info@omporro.eu
alfredoporro.it