



ARMAC MARTIN™

Est. 1929 · BIRMINGHAM · ENGLAND

PRODUCT GUIDE 2022

For the defining details

CONTENTS

INTRODUCTION

Our Story	4
Bespoke	6
Our Finishes	8

COLLECTIONS

Digbeth	16
Claremont	20
Shelf Brackets	22
Crossways	26
Harold	28
MIX	30
Bromford	34
Bromsgrove	36
Bromwich	38
Arbar	40
Leebank	42
Sparkbrook	44
Kingsheath	46
Rotunda	48
Gaumont	50
Carlton	52
Dougan	54
Jefferson	56
Lincoln	57
Sutton	58
Queslett	60
Washwood	62
Cotswold	64
Withenshaw	68
Bakes	70
Belgrave	72
Latchford	74
Merrick	75
Snowdrift	76
Bournville	77

Aberdovey	78
Edgbaston	80
Quinton	82
Jaspette	84
Longbridge	86
Croxford	88
Quadrille	89
Oblique	90
Flush Pulls	92

ADDITIONAL

Cabinet Handles	94
Cabinet Knobs	95
Hooks	96
Cardframes	97
Hinges	98
Finials & Screws	98
Magnetic Catches	99

DECORATIVE GRILLES

Grille Finishes	102
Regency Diamond	104
Elliptical	106
Georgian Square	108
Diamond Interwoven	110
Square Interwoven	112
Double Square Interwoven	114
Double Diamond Interwoven	116
Double Rectangular Interwoven	118
Perforated Sheets	120
Metal Frames	122
Mesh	123
How to order your grille	124

ACKNOWLEDGEMENTS & CONTACT US	126
----------------------------------	-----



OUR STORY

Dedicated to creating beautiful luxury cabinet hardware for nearly a century, we believe in exceptional design and exquisite detail, in celebrating true craftsmanship and in the art of using the finest materials to form products that truly stand the test of time.

Now a fourth-generation family business, our expertise has been thoughtfully passed down from generation to generation and we are proud to be favoured by architects, interior designers and property developers the world over.

Brass has a rich history with the application of the material used to protect and decorate through the ages. The material is timeless, luxurious and above all, the beauty of brass lies in the vast array of finishes that can transform each product.

From initial design sketches to masterfully hand-finishing every single piece of hardware, we oversee each phase of production in the heart of England at our Birmingham factory.

Our products can be found in some of the world's finest homes, hotels and spaces – something that continues to drive our commitment to excellence.





BESPOKE

At Armac Martin, we understand that sometimes, you may require a piece or indeed a collection specially made for your interior design project and so we're proud to offer both full and partial bespoke design and manufacturing services. With nearing a century of experience, let our skilled team impeccably transform your ideas into the perfect brass fixtures and fittings for when you simply need something one of a kind.

THE DETAILS

We are delighted to invite each of our bespoke clients to visit us at our Birmingham factory where we can help to inspire your designs and you can experience the manufacturing process in person. Our bespoke service includes:

CAD	3D rendering and technical drawings so you can clearly visualise your hardware
3D PRINTING	3D printing from our prompt prototyping machine to produce a prototype that you can see and feel to experience the design and proportions
ENGRAVING	Laser engraving to subtly add your own branding on a wide array of bespoke products and our core collections
SUPPORT	Expert technical sales support so you have a personal contact throughout

FULLY BESPOKE

No matter what form your design ideas are in, work with our dedicated team to create a completely bespoke product. From size and style to branded engraving, we'll create 3D designs so you can experience how the finished hardware will look and feel to ensure it fits with your project, before creating final technical drawings for you to sign off before production begins.

Lead times are primarily between 8 - 12 weeks for this service.

PARTIALLY BESPOKE

Our partially bespoke service is perfect for when you've found the hardware pieces you need from one of our core collections, yet the measurements aren't quite right for your design. We can customise the length, diameter and projection for you so that the hardware fits perfectly to your project.

Lead times are primarily between 6 - 8 weeks for this service.



Bespoke inset handles in our burnished brass finish

OUR FINISHES

We truly believe that luxury is in the detail and so we take great pride in offering our customers over 20 beautiful signature finishes to ensure your hardware has the look and feel you desire. Each of our luxury cabinet hardware products and accessories are made from the finest solid brass and we apply an array of plated and patinated finishes to create an exquisite look for each - many of which are hand-finished by our team of expert polishers in the heart of Birmingham.



PBL - Polished brass lacquered

The product is hand-polished to achieve a smooth mirrored finish. A highly durable clear gloss lacquer is then applied and cured in our ovens to ensure lasting protection. This hard and durable layer will protect the finish from day-to-day usage and oxidation.



PBUL - Polished brass unlacquered

The product is hand polished to a smooth mirrored finish. As this is a natural living finish, the finish will naturally oxidise and patina over time.

To help maintain and preserve the finish it is recommended that you use a good quality metal polish as required.



SBL - Satin brass lacquered

The product is hand sateened to give a brushed satin finish. A highly durable clear gloss lacquer is then applied and cured in our ovens to ensure lasting protection. This hard and durable layer will protect the finish from day-to-day usage and oxidation.



SBUL - Satin brass unlacquered

The product is hand sateened to give a brushed satin finish. As this is a natural living finish, the finish will naturally oxidise and patina over time.



SBSL - Satin brass satin lacquered

The product is hand sateened to give a brushed satin finish. A highly durable clear satin lacquer is then applied and cured in our ovens to ensure lasting protection. This hard and durable layer will protect the finish from day-to-day usage and oxidation.



HBB - Hand burnished brass

The product is hand polished to a smooth mirrored brass finish. The finisher then hand burnishes the product to achieve a natural looking aged appearance.

The hand burnished brass finish is not lacquered and as a result, is classed as a living finish which will oxidise over time.



ABL - Antique brass lacquered

The product is hand polished to a smooth mirrored finish. An antique patina is then applied to the brass before being relieved back to give the antique finish.

Finally, a highly durable clear gloss lacquer is then applied which is baked in our ovens to ensure the lacquer cures to offer lasting protection. Baking the lacquer ensures that a harder and more durable layer will protect the finish from day to day usage and oxidation.



ABUL - Antique brass unlacquered

The product is hand polished to a smooth mirrored finish. An antique patina is then applied to the brass before being relieved back to give the antique finish.

As this is a natural living finish the finish will naturally oxidise and patina over time. The more the product is handled the faster the finish will wear away, eventually leading to a more natural brass appearance.



BEL - Burnished brass

The product is hand sateened to give a brushed satin finish. A light antique patina is then applied to the brass before being placed into barrelling machines full of cones. This is in order to achieve a naturally aged appearance to the product.



ACP - Antique copper plate lacquered

The product is hand sateened to give a brushed satin finish. A copper plate is then applied on top of the brass. The polisher then relieves the finish to give an antique copper finish.

Finally, a highly durable clear satin lacquer is then applied and cured in our ovens to ensure lasting protection. This hard and durable layer will protect the finish from day-to-day usage and oxidisation.



MBL - Matt black lacquered

The product is hand sateened before it is shot blasted to give the metal the desired textured matt finish.

Finally, a highly durable matt black coloured lacquer is then applied and cured in our ovens to ensure lasting protection. This hard and durable layer will protect the finish from day-to-day usage and oxidisation.



MWL - Matt white lacquered

The product is hand sateened before it is shot blasted to give the metal the desired textured matt finish.

Finally, a highly durable matt white coloured lacquer is then applied and cured in our ovens to ensure lasting protection. This hard and durable layer will protect the finish from day-to-day usage and oxidisation.



SAS - Satin antique satin lacquered

The product is hand sateened to give a brushed satin finish. An antique patina is then applied to the brass before being relieved back to give the satin antique finish.

Finally, a highly durable clear satin lacquer is then applied and cured in our ovens to ensure lasting protection. This hard and durable layer will protect the finish from day-to-day usage and oxidisation.



SAL - Satin antique gloss lacquered

The product is hand sateened to give a brushed satin finish. An antique patina is then applied to the brass before being relieved back to give the satin antique finish.

Finally, a highly durable clear gloss lacquer is then applied and cured in our ovens to ensure lasting protection. This hard and durable layer will protect the finish from day-to-day usage and oxidisation.



AMB - American bronze lacquered

The product is hand sateened to give a brushed satin finish. A bronzing powder is then evenly applied to the brass before being relieved to give a smooth consistent finish.

Finally, a highly durable clear gloss lacquer is then applied and cured in our ovens to ensure lasting protection. This hard and durable layer will protect the finish from day-to-day usage and oxidisation.



CBP - Chocolate bronze lacquered

The product is hand sateened to give a brushed satin finish. A bright copper plate is then applied. A bronzing powder is then evenly applied to the copper before being relieved to give a smooth consistent finish with a copper undertone through the bronze.

Finally, a highly durable clear satin lacquer is then applied and cured in our ovens to ensure lasting protection. This hard and durable layer will protect the finish from day-to-day usage and oxidisation.



ASP - Antique silver plate lacquered

The product is hand sateened to give a brushed satin finish. A silver plate is then applied before a bronzing powder is applied on top of the silver. The finish is then relieved to give an antique silver finish.

Finally, a highly durable clear satin lacquer is then applied and cured in our ovens to ensure lasting protection. This hard and durable layer will protect the finish from day-to-day usage and oxidisation.



PNP - Polished nickel plate

The product is hand polished to a smooth mirrored finish. A bright nickel plate is then applied.

Nickel finish is less durable than chrome and as a result, is classed as a living finish which will oxidise over time.



PCP - Polished chrome plate

The product is hand polished to a smooth mirrored finish. A bright nickel plate is then applied before a chromium plate is applied on top of the nickel.

Chromium plate provides a very durable and hard-wearing finish.



SNP – Satin nickel plate

The product is hand sateened to give a brushed satin finish. A dull nickel plate is then applied.

Nickel finish is less durable than chrome and as a result, is classed as a living finish which will oxidise over time.



SCP – Satin chrome plate

The product is hand sateened to give a brushed satin finish. A dull nickel plate is then applied before a chromium plate is applied on top of the nickel.

Chromium plate provides a very durable and hard-wearing finish.



NBP – Barrelled nickel plate

The product is hand sateened to give a brushed satin finish. The product is then lightly distressed. Finally, a dull nickel plate is applied to the product.

Nickel finish is less durable than chrome and as a result, is classed as a living finish which will oxidise over time.



HBN – Hand burnished nickel

The product is hand polished to a smooth mirrored finish. A bright nickel plate is then applied. The finisher then hand burnishes the product to achieve a natural looking aged appearance.

Nickel finish is less durable than chrome and as a result, is classed as a living finish which will oxidise over time.

OUR COLLECTIONS

Designed to enhance your interior cabinetry and make every detail one to take note of, each of our luxury solid brass collections is thoughtfully designed in-house. Producing the finest fixtures and fittings in an array of covetable styles, our collections promise to cater for every interior look imaginable. From minimal and modern to those inspired by times gone by like the art-deco era, discover over 35 exquisite collections to adorn your cabinets.





MIX Diamond Appliance Handle with backplate, Edgbaston Pull, Regency Diamond Grille, Sparkbrook Handle, MIX Diamond Knob with backplate in our satin brass unlacquered finish

DIGBETH COLLECTION

Discover luxury hardware redefined. Presenting industrial design-led style, the Digbeth collection offers a choice of textured hand-finished linear ridging or smooth brass. Frame each piece by opting for a striking backplate.

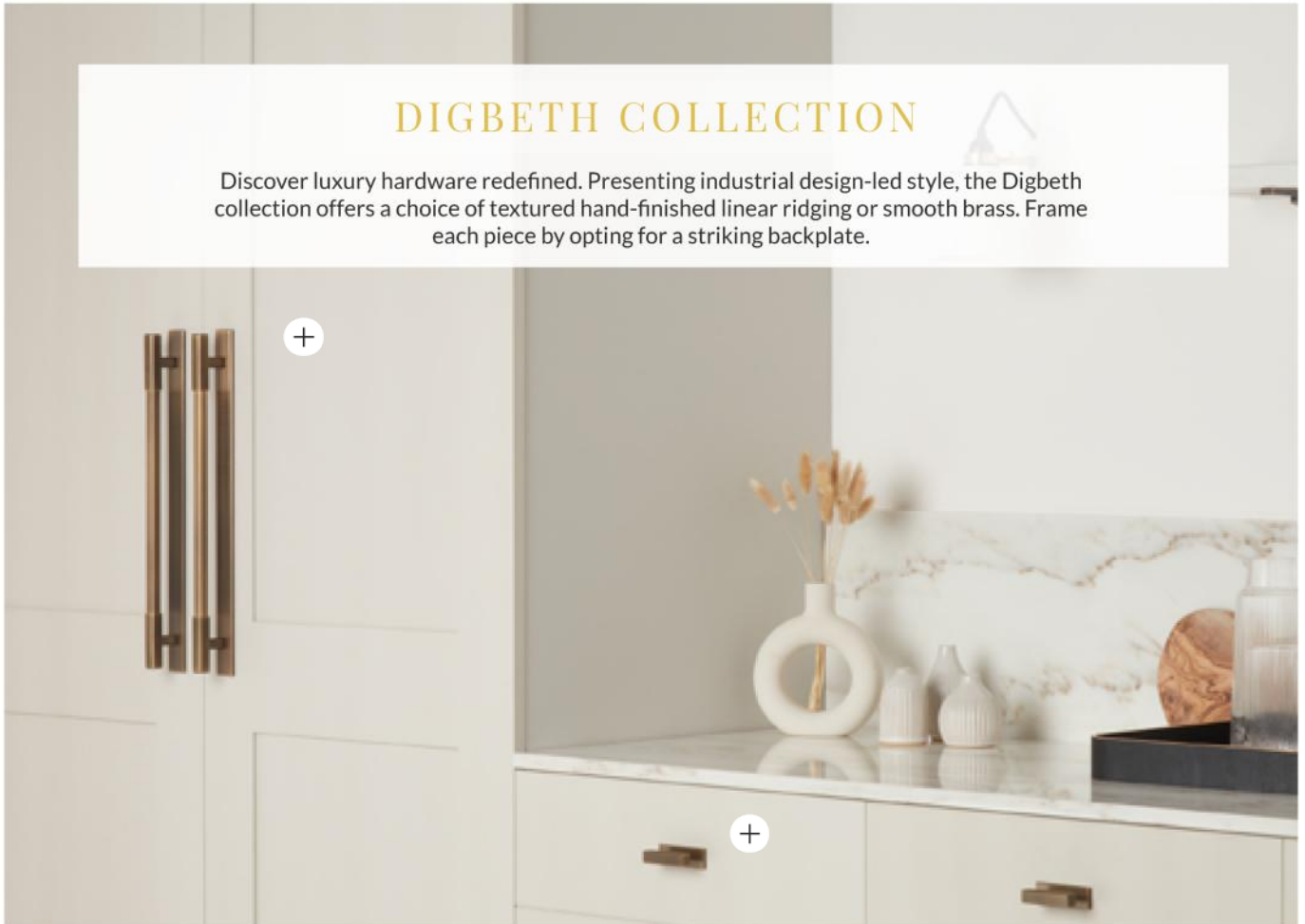

DIGBETH RIDGED CABINET KNOB

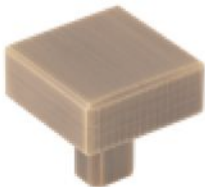

Code	Width sq. (W)	Projection (P)	Pin dia. (PI)	Stem (S)	X
DIGK/KNOBONLY/32	32mm	31mm	2.5mm	17mm	14mm
DIGK/KNOBONLY/38	38mm	33mm	2.5mm	17mm	16mm

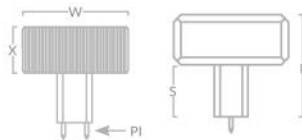

DIGBETH RIDGED CABINET KNOB WITH BACKPLATE

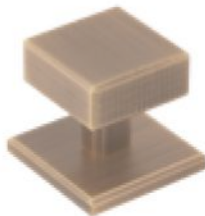

Code	Width sq. (W)	Projection (P)	Pin dia. (PI)	Stem (S)	Plate Width sq. (PW)	Plate Thickness (T)	X
DIGK/32	32mm	35mm	2.5mm	22mm	38mm	5mm	14mm
DIGK/38	38mm	38mm	2.5mm	22mm	45mm	5mm	16mm

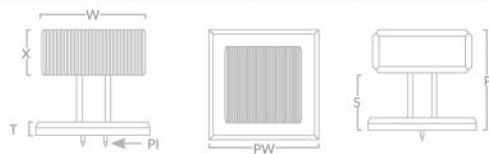

DIGBETH RIDGED T-BAR HANDLE



Code	Length (L)	Width sq. (W)	Projection (P)	Stem (S)	Pin Dia (PI)
DIGT/TBARONLY/67	67mm	16mm	33mm	17mm	2.5mm

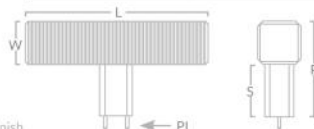

Not suitable for appliance doors

All product photographed in our satin antique satin lacquered finish

DIGBETH RIDGED T-BAR HANDLE WITH BACKPLATE

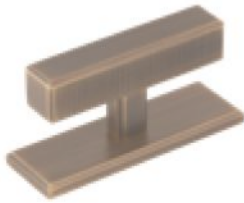

Code	Length (L)	Width sq. (W)	Projection (P)	Stem (S)	Pin Dia (PI)	Plate Length (PL)	Plate Width (PW)	Plate Thickness (T)
DIGT/67	67mm	16mm	38mm	22mm	2.5mm	77mm	25mm	5mm

Not suitable for appliance doors

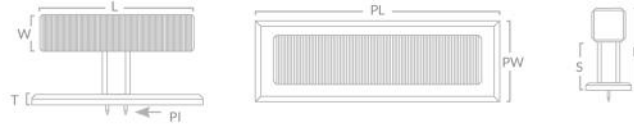

DIGBETH RIDGED CABINET & APPLIANCE HANDLE



Code	Centres (C)	Length (L)	Width sq. (W)	Stem (S)	Projection (P)
DIG/PULLONLY/128	128mm	182mm	12.7mm	20mm	33mm
DIG/PULLONLY/160	160mm	217mm	16mm	23mm	39mm
DIG/PULLONLY/224	224mm	291mm	16mm	23mm	39mm
DIG/PULLONLY/288	288mm	355mm	16mm	23mm	39mm
DIG/PULLONLY/APP/384	384mm	461mm	19mm	30mm	49mm
DIG/PULLONLY/APP/608	608mm	685mm	19mm	30mm	49mm

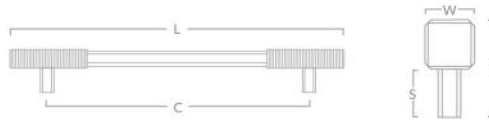

DIGBETH RIDGED CABINET & APPLIANCE HANDLE WITH BACKPLATE



Code	Centres (C)	Length (L)	Width sq. (W)	Stem (S)	Projection (P)	Plate Thickness (T)	Plate Length (PL)	Plate Width (PW)
DIG/128	128mm	182mm	12.7mm	25mm	37mm	5mm	191mm	22mm
DIG/160	160mm	217mm	16mm	29mm	45mm	6.5mm	227mm	25mm
DIG/224	224mm	291mm	16mm	29mm	45mm	6.5mm	301mm	25mm
DIG/288	288mm	355mm	16mm	29mm	45mm	6.5mm	365mm	25mm
DIG/APP/384	384mm	461mm	19mm	36mm	55mm	6.5mm	474mm	32mm
DIG/APP/608	608mm	685mm	19mm	36mm	55mm	6.5mm	698mm	32mm



DIGBETH RIDGED HOOK



Code	Width sq. (W)	Projection (P)	Length (L)	Stem (S)	Plate Width (PW)	Plate Length (PL)	Plate Thickness (T)
DIG/HOOK/48	16mm	39mm	48mm	32mm	25mm	58mm	6.5mm

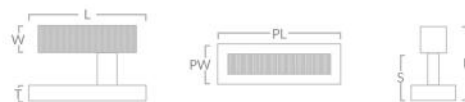

DIGBETH RIDGED LATCH



Code	Projection (P)	Length (L)	Plate Width (PW)	Plate Length (PL)	Plate Thickness (T)
DIG/LATCH/FLUSH/45	20mm	108mm	45mm	64mm	5mm
DIG/LATCH/FLUSH/55	30mm	153mm	55mm	81mm	6mm



Product photographed in our satin antique satin lacquered finish



DIGBETH PLAIN CABINET KNOB



Code	Width sq. (W)	Projection (P)	Pin dia. (PI)	Stem (S)	X
DIGK/KNOBONLY/PLAIN/32	32mm	31mm	2.5mm	17mm	14mm
DIGK/KNOBONLY/PLAIN/38	38mm	33mm	2.5mm	17mm	16mm

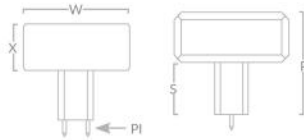

DIGBETH PLAIN CABINET KNOB WITH BACKPLATE



Code	Width sq. (W)	Projection (P)	Pin dia. (PI)	Stem (S)	Plate Width sq. (PW)	Plate Thickness (T)	X
DIGK/PLAIN/32	32mm	35mm	2.5mm	22mm	38mm	5mm	14mm
DIGK/PLAIN/38	38mm	38mm	2.5mm	22mm	45mm	5mm	16mm



DIGBETH PLAIN T-BAR HANDLE



Code	Length (L)	Width sq. (W)	Projection (P)	Stem (S)	Pin Dia (PI)
DIGT/TBARONLY/PLAIN/67	67mm	16mm	33mm	17mm	2.5mm

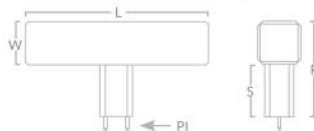

Not suitable for appliance doors

All product photographed in our burnished brass finish

DIGBETH PLAIN T-BAR HANDLE WITH BACKPLATE



Code	Length (L)	Width sq. (W)	Projection (P)	Stem (S)	Pin Dia (PI)	Plate Length (PL)	Plate Width (PW)	Plate Thickness (T)
DIGT/PLAIN/67	67mm	16mm	38mm	22mm	2.5mm	77mm	25mm	5mm

Not suitable for appliance doors

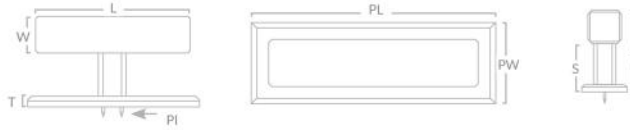

DIGBETH PLAIN CABINET & APPLIANCE HANDLE



Code	Centres (C)	Length (L)	Width sq. (W)	Stem (S)	Projection (P)
DIG/PULLONLY/PLAIN/128	128mm	182mm	12.7mm	20mm	33mm
DIG/PULLONLY/PLAIN/160	160mm	217mm	16mm	23mm	39mm
DIG/PULLONLY/PLAIN/224	224mm	291mm	16mm	23mm	39mm
DIG/PULLONLY/PLAIN/288	288mm	355mm	16mm	23mm	39mm
DIG/PULLONLY/APP/PLAIN/384	384mm	461mm	19mm	30mm	49mm
DIG/PULLONLY/APP/PLAIN/608	608mm	685mm	19mm </td <td>30mm</td> <td>49mm</td>	30mm	49mm

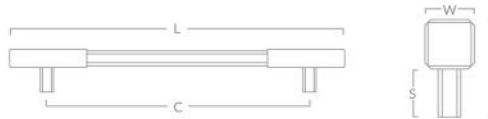

DIGBETH PLAIN CABINET & APPLIANCE HANDLE WITH BACKPLATE



Code	Centres (C)	Length (L)	Width sq. (W)	Stem (S)	Projection (P)	Plate Thickness (T)	Plate Length (PL)	Plate Width (PW)
DIG/PLAIN/128	128mm	182mm	12.7mm	25mm	37mm	5mm	191mm	22mm
DIG/PLAIN/160	160mm	217mm	16mm	29mm	45mm	6.5mm	227mm	25mm
DIG/PLAIN/224	224mm	291mm	16mm	29mm	45mm	6.5mm	301mm	25mm
DIG/PLAIN/288	288mm	355mm	16mm	29mm	45mm	6.5mm	365mm	25mm
DIG/APP/PLAIN/384	384mm	461mm	19mm	36mm	55mm	6.5mm	474mm	32mm
DIG/APP/PLAIN/608	608mm	685mm	19mm	36mm	55mm	6.5mm	698mm	32mm



DIGBETH PLAIN HOOK



Code	Width sq. (W)	Projection (P)	Length (L)	Stem (S)	Plate Width (PW)	Plate Length (PL)	Plate Thickness (T)
DIG/HOOK/PLAIN/48	16mm	39mm	48mm	32mm	25mm	58mm	6.5mm

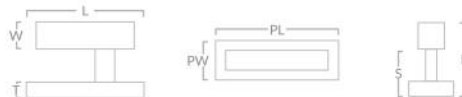

DIGBETH PLAIN LATCH



Code	Projection (P)	Length (L)	Plate Width (PW)	Plate Length (PL)	Plate Thickness (T)
DIG/LATCH/FLUSH/PLAIN/45	20mm	108mm	45mm	64mm	5mm
DIG/LATCH/FLUSH/PLAIN/55	30mm	153mm	55mm	81mm	6mm

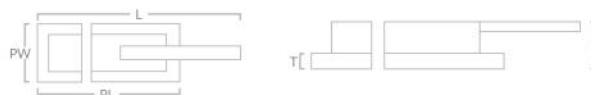

Product photographed in our burnished brass finish

THE CLAREMONT COLLECTION

Designed by eminent interior designer Sophie Paterson, The Claremont Collection is a debut range of desirable luxury brass mirrors, featuring three impeccably crafted mirrors in a timeless satin antique satin lacquered finish. Each mirror promises to bring pure sophistication to bedrooms and dressing rooms alike.

'Together we wanted to create a range that would work in any interior from classic to contemporary, with a timeless design that would be equally functional and beautiful.'

- Sophie Paterson

CLAREMONT VANITY MIRROR



Code	Height (H)	Width (W)	Base Width (BW)	Depth (D)	Mirror Diameter (M)	Mirror Weight
CLM/VAN/SAS	360mm	218mm	114mm	90mm	167mm	1.5kg

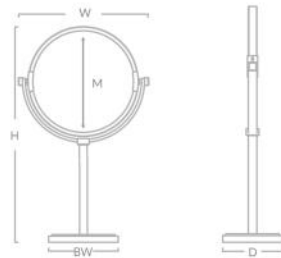

CLAREMONT DRESSING TABLE MIRROR



Code	Height (H)	Width (W)	Base Width (BW)	Depth (D)	Mirror Height (MH)	Mirror Width (MW)	Mirror Weight
CLM/DRS/SAS	505mm	356mm	200mm	150mm	315mm	275mm	7kg

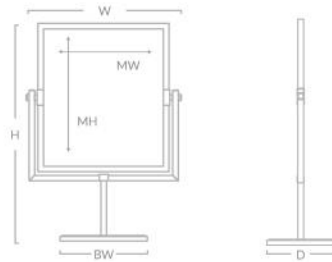

CLAREMONT PANELLED DRESSING TABLE MIRROR



Code	Height (H)	Width (W)	Depth (D)	Mirror Height (MH)	Mirror Width (MW)	Side Mirror Height (SH)	Side Mirror Width (SW)	Mirror Weight
CLM/PNL/SAS	650mm	770mm	230mm	574mm	324mm	574mm	123mm	16kg

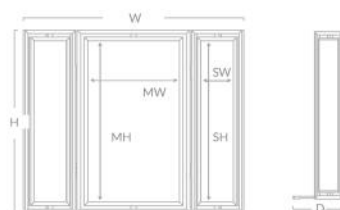

Product photographed in our satin antique satin lacquered finish



Claremont Panelled Dressing Table Mirror & Crossways T-Bar Handle in our satin antique satin lacquered finish

SHELF BRACKETS

Accentuate your interiors with our collection of stylish shelf brackets that channel a minimal aesthetic, focusing on flawless contours.



HARBORNE SHELF BRACKET



Code	Width (W)	Centres (C)	Height (H)	Projection (P)	Shelf Radius (R)	X	Shelf Support (S)
HAB/BRKT/190	25mm	218mm	243mm	206mm	13mm	60mm	190mm
HAB/BRKT/250	25mm	290mm	315mm	266mm	13mm	64mm	250mm

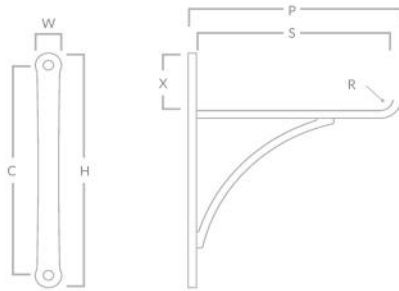

MOSELEY SHELF BRACKET



Code	Width (W)	Centres (C)	Height (H)	Projection (P)	X	Shelf Support (S)
MOS/BRKT/190	19mm	226mm	245mm	198mm	60mm	190mm
MOS/BRKT/250	19mm	301mm	320mm	258mm	61mm	250mm

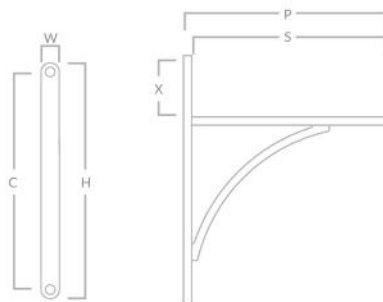

All product photographed in our burnished brass finish

STIRCHLEY SHELF BRACKET



Code	Width (W)	Centres (C)	Height (H)	Projection (P)	X	Shelf Support (S)
STR/BRKT/190	19mm	215mm	245mm	198mm	60mm	190mm
STR/BRKT/250	19mm	290mm	320mm	258mm	61mm	250mm

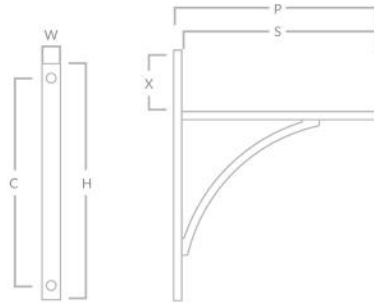

HANDSWORTH FLUSH MOUNTED SHELF BRACKET



Code	Width (W)	Projection (P)	Height (H)	Centres (C)
HND/BRKT/190	19mm	198mm	185mm	146mm
HND/BRKT/250	19mm	258mm	259mm	205mm

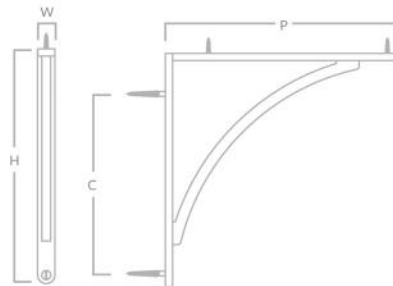

HOCKLEY FLUSH MOUNTED SHELF BRACKET



Code	Width (W)	Projection (P)	Height (H)	Centres (C)
HOC/BRKT/190	19mm	198mm	185mm	140mm
HOC/BRKT/250	19mm	258mm	259mm	199mm

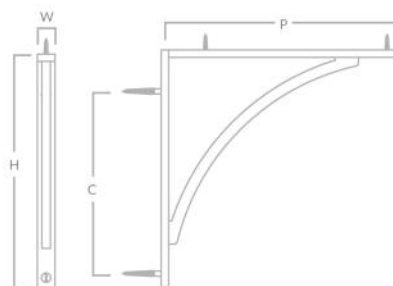



Handsworth Flush Mounted Shelf Bracket in our burnished brass finish



+

Hockley Flush Mounted Shelf Bracket in our matt white lacquered finish

CROSSWAYS COLLECTION

Featuring stylish Geometric shapes, Crossways is an exquisite collection of luxury brass hardware with a distinct art deco appeal.

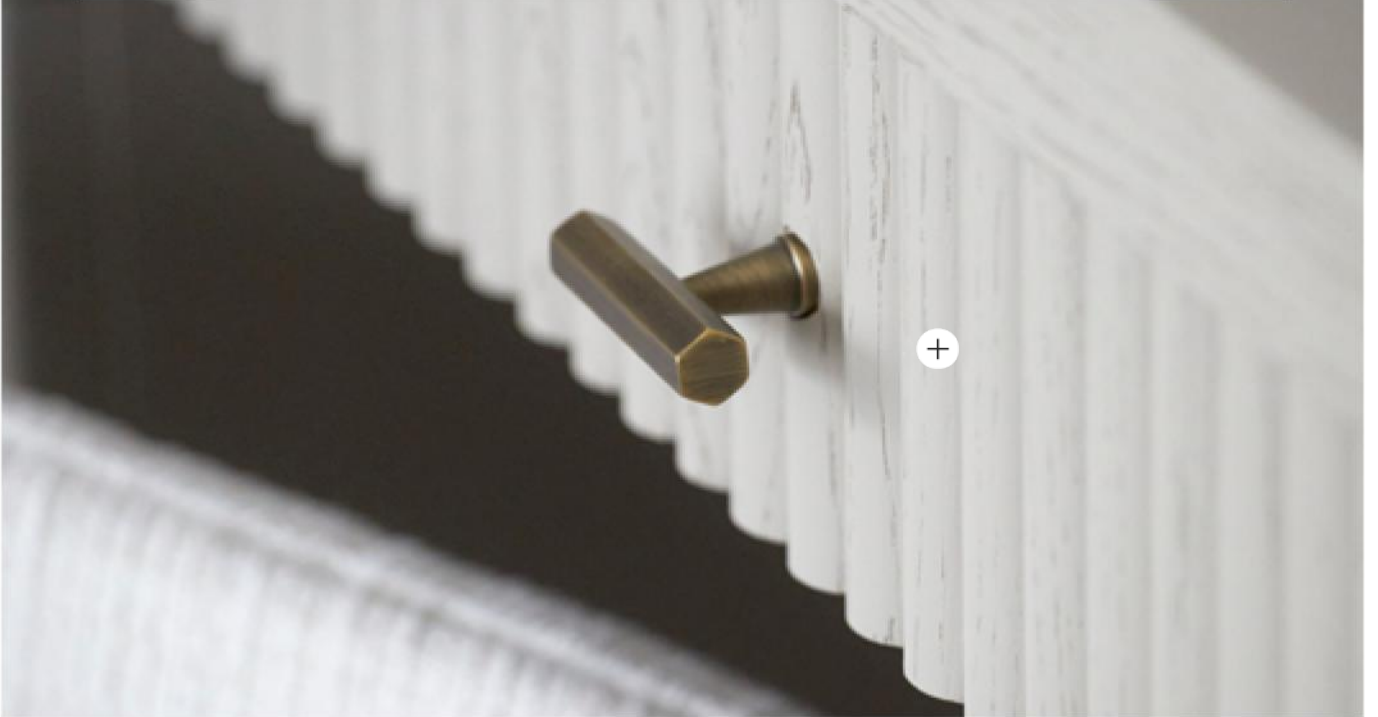

CROSSWAYS CABINET KNOB

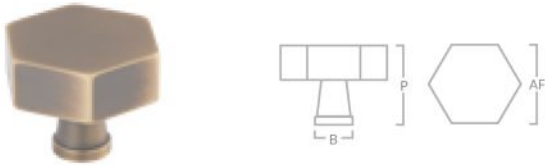

Code	Projection (P)	Base (B)	Across Flats (AF)
CRWK/32	28mm	13mm	32mm

CROSSWAYS T-BAR HANDLE

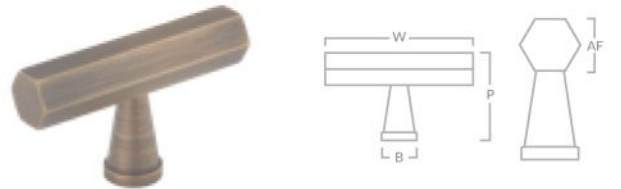

Code	Width (W)	Projection (P)	Base (B)	Across Flats (AF)
CRWT/55	55mm	33mm	13mm	12mm

Not suitable for appliance doors

CROSSWAYS CABINET RING PULL



Code	Width (W)	Projection	Height (H)	Rose (R)
CRWR/36	36mm	10mm	46mm	25mm

CROSSWAYS CUP PULL



Code	Centres (C)	Width (W)	Height (H)	Projection
CRW/CUP/104	90mm	104mm	45mm	20mm

All product photographed in our satin antique satin lacquered finish

CROSSWAYS CABINET HANDLE



Code	Centres (C)	Length (L)	Projection (P)	Bar Across Flats
CRW/64	64mm	102mm	33mm	12mm
CRW/96	96mm	134mm	33mm	12mm
CRW/128	128mm	166mm	33mm	12mm
CRW/160	160mm	198mm	33mm	12mm
CRW/288	288mm	326mm	33mm	12mm

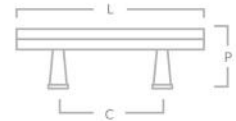

CROSSWAYS APPLIANCE HANDLE



Code	Centres (C)	Length (L)	Projection (P)	Bar Across Flats
CRW/APP/384	384mm	434mm	45mm	15.9mm
CRW/APP/608	608mm	658mm	45mm	15.9mm

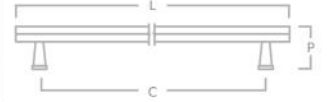

CROSSWAYS PLATE CABINET HANDLE



Code	Centres (C)	Width (W)	Height (H)
CRWP/64	64mm	89mm	32mm

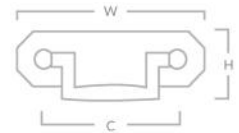

CROSSWAYS CABINET DROP HANDLE



Code	Centres (C)	Width (W)	Height (H)
CRWC/80	80mm	105mm	38mm
CRWC/102	102mm	129mm	47mm

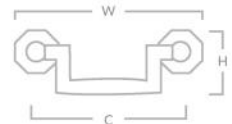

CROSSWAYS HEX DROP HANDLE



Code	Width (W)	Projection	Height (H)
CRWD/38	25mm	16mm	56mm



CROSSWAYS PEDESTAL DROP HANDLE



Code	Width (W)	Height (H)	Projection
CRW/PED/89	25mm	89mm	13mm



HAROLD COLLECTION

Created to celebrate 90 years of Armac Martin, the Harold collection takes inspiration from our treasured heritage and one of our original founders.



Harold T-Bar Handle in our satin antique satin lacquered finish

HAROLD HAMMERED CABINET KNOB



Code	Width (W)	Projection (P)	Base (B)
HRLK/32	32mm	29mm	20mm

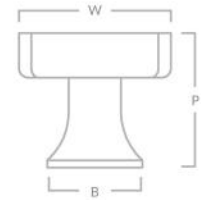

HAROLD HAMMERED T-BAR HANDLE



Code	Width (W)	Projection (P)	Base (B)
HRLT/58	58mm	29mm	20mm

Not suitable for appliance doors

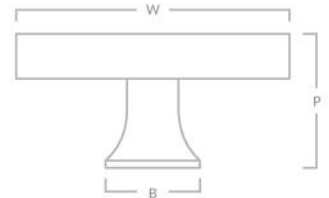

HAROLD HAMMERED CABINET & APPLIANCE HANDLE



Code	Length (L)	Centres (C)	Projection (P)	Bar Width
HRL/96	116mm	96mm	29mm	20mm x 9.5mm
HRL/160	184mm	160mm	31mm	23mm x 9.5mm
HRL/224	248mm	224mm	31mm	25mm x 9.5mm
HRL/APP/352	382mm	352mm	41mm	28mm x 12.7mm

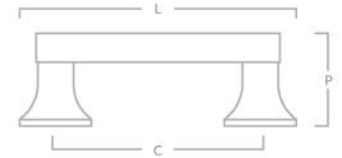

HAROLD PLAIN CABINET KNOB



Code	Width (W)	Projection (P)	Base (B)
HRLK/PLAIN/32	32mm	29mm	20mm

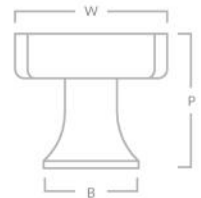

HAROLD PLAIN T-BAR HANDLE



Code	Width (W)	Projection (P)	Base (B)
HRLT/PLAIN/58	58mm	29mm	20mm

Not suitable for appliance doors

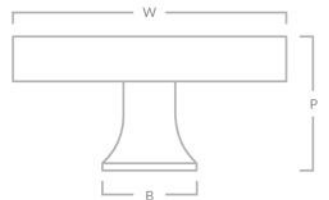

HAROLD PLAIN CABINET & APPLIANCE HANDLE



Code	Length (L)	Centres (C)	Projection (P)	Bar Width
HRL/PLAIN/96	116mm	96mm	29mm	20mm x 9.5mm
HRL/PLAIN/160	184mm	160mm	31mm	23mm x 9.5mm
HRL/PLAIN/224	248mm	224mm	31mm	25mm x 9.5mm
HRL/APP/PLAIN/352	382mm	352mm	41mm	28mm x 12.7mm

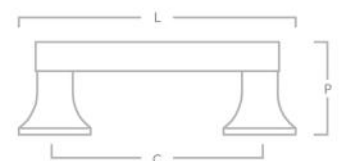

MIX COLLECTION

'Made by us. Mixed by you.' Say hello to MIX, an innovative collection of interchangeable cabinet hardware that gives you more control over your design.



MIX DIAMOND CABINET KNOB



Code	Diameter (Dia.)	Projection (P)	Base (B)
MIX1/KNOBONLY/32	32mm	29mm	10mm

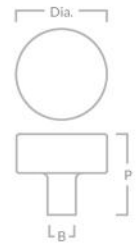

MIX DIAMOND CABINET KNOB WITH BACKPLATE



Code	Depth (D)	Centres (C)	Width (W)	Diameter (Dia.)	Projection (P)
MIX1/54	25mm	54mm	80mm	32mm	34mm
MIX1/128	25mm	128mm	154mm	32mm	34mm
MIX1/192	25mm	192mm	218mm	32mm	34mm

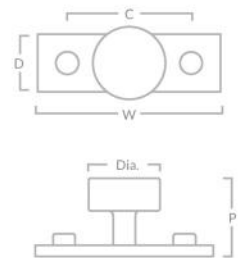

MIX DIAMOND CABINET & APPLIANCE HANDLE



Code	Centres (C)	Bar Diameter	Length (L)	Projection (P)
MIX1/PULLONLY/160	160mm	13mm	202mm	34mm
MIX1/PULLONLY/224	224mm	14mm	274mm	37mm
MIX1/PULLONLY/288	288mm	14mm	338mm	37mm
MIX1/PULLONLY/APP/384	384mm	18mm	434mm	50mm
MIX1/PULLONLY/APP/608	608mm	18mm	658mm	50mm



All product photographed in our burnished brass finish

MIX DIAMOND CABINET & APPLIANCE HANDLE WITH BACKPLATE



Code	Centres (C)	Bar Dia.	Length (L)	Projection (P)	Base (B)	Depth (D)
MIX1/160	160mm	13mm	230mm	39mm	5mm	25mm
MIX1/224	224mm	14mm	310mm	42mm	5mm	32mm
MIX1/288	288mm	14mm	374mm	42mm	5mm	32mm
MIX1/APP/384	384mm	18mm	470mm	56mm	6mm	35mm
MIX1/APP/608	608mm	18mm	694mm	56mm	6mm	35mm

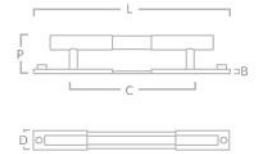

MIX STRAIGHT CABINET KNOB



Code	Diameter (Dia.)	Projection (P)	Base (B)
MIX2/KNOBONLY/32	32mm	29mm	10mm

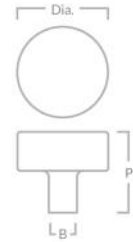

MIX STRAIGHT CABINET KNOB WITH BACKPLATE



Code	Depth (D)	Centres (C)	Width (W)	Diameter (Dia.)	Projection (P)
MIX2/54	25mm	54mm	80mm	32mm	34mm
MIX2/128	25mm	128mm	154mm	32mm	34mm
MIX2/192	25mm	192mm	218mm	32mm	34mm

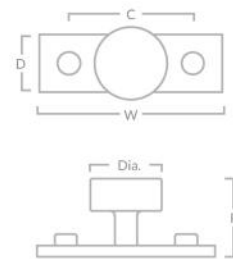

MIX STRAIGHT CABINET & APPLIANCE HANDLE



Code	Centres (C)	Bar Diameter	Length (L)	Projection (P)
MIX2/PULLONLY/160	160mm	13mm	202mm	34mm
MIX2/PULLONLY/224	224mm	14mm	274mm	37mm
MIX2/PULLONLY/288	288mm	14mm	338mm	37mm
MIX2/PULLONLY/APP/384	384mm	18mm	434mm	50mm
MIX2/PULLONLY/APP/608	608mm	18mm	658mm	50mm

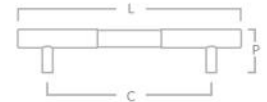

MIX STRAIGHT CABINET & APPLIANCE HANDLE WITH BACKPLATE



Code	Centres (C)	Bar Dia.	Length (L)	Projection (P)	Base (B)	Depth (D)
MIX2/160	160mm	13mm	230mm	39mm	5mm	25mm
MIX2/224	224mm	14mm	310mm	42mm	5mm	32mm
MIX2/288	288mm	14mm	374mm	42mm	5mm	32mm
MIX2/APP/384	384mm	18mm	470mm	56mm	6mm	35mm
MIX2/APP/608	608mm	18mm	694mm	56mm	6mm	35mm

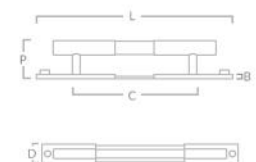

MIX PLAIN CABINET KNOB



Code	Diameter (Dia.)	Projection (P)	Base (B)
MIX3/KNOBONLY/32	32mm	29mm	10mm



Product photographed in our burnished brass finish

MIX PLAIN CABINET KNOB WITH BACKPLATE



Code	Depth (D)	Centres (C)	Width (W)	Diameter (Dia.)	Projection (P)
MIX3/54	25mm	54mm	80mm	32mm	34mm
MIX3/128	25mm	128mm	154mm	32mm	34mm
MIX3/192	25mm	192mm	218mm	32mm	34mm

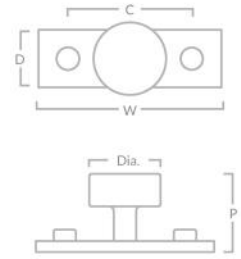

MIX PLAIN CABINET & APPLIANCE HANDLE



Code	Centres (C)	Bar Diameter	Length (L)	Projection (P)
MIX3/PULLONLY/160	160mm	13mm	202mm	34mm
MIX3/PULLONLY/224	224mm	14mm	274mm	37mm
MIX3/PULLONLY/288	288mm	14mm	338mm	37mm
MIX3/PULLONLY/APP/384	384mm	18mm	434mm	50mm
MIX2/PULLONLY/APP/608	608mm	18mm	658mm	50mm

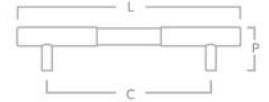

MIX PLAIN CABINET & APPLIANCE HANDLE WITH BACKPLATE



Code	Centres (C)	Bar Dia.	Length (L)	Projection (P)	Base (B)	Depth (D)
MIX3/160	160mm	13mm	230mm	39mm	5mm	25mm
MIX3/224	224mm	14mm	310mm	42mm	5mm	32mm
MIX3/288	288mm	14mm	374mm	42mm	5mm	32mm
MIX3/APP/384	384mm	18mm	470mm	56mm	6mm	35mm
MIX3/APP/608	608mm	18mm	694mm	56mm	6mm	35mm



MIX Straight Cabinet Knob with backplate in our burnished brass on matt black lacquered finish & Cotswold Cupboard Latch in our burnished brass finish



MIX Straight Handle with backplate & Longbridge Pull in our burnished brass finish

BROMFORD COLLECTION

A contemporary classic, the Bromford collection promises to make an impact in modern homes with bold lines at the forefront of each handle design.



BROMFORD CABINET KNOB



Code	Width (W)	Projection (P)	Base (B)
BRMK/32	32mm	33mm	25mm

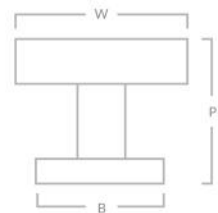

BROMFORD DROP HANDLE



Code	Width (W)	Projection (P)	Length (L)
BRMD/60	25mm	22mm	68mm

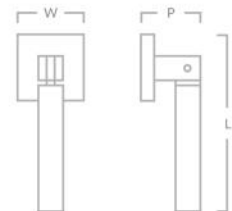

BROMFORD CABINET & APPLIANCE HANDLE



Code	Length (L)	Centres (C)	Projection (P)	Bar (Sq.)
BRM/96	121mm	96mm	31mm	9.5mm
BRM/128	153mm	128mm	31mm	9.5mm
BRM/203	228mm	203mm	33mm	9.5mm
BRM/305	337mm	305mm	42mm	12.7mm
BRM/APP/381	419mm	381mm	46mm	16mm
BRM/APP/608	646mm	608mm	46mm	16mm



Product photographed in our satin antique satin lacquered finish | In-situ photographed in our burnished brass finish



Bromford Cabinet Handle in our burnished brass finish

BROMSGROVE COLLECTION

For minimal design with maximum impact, Bromsgrove showcases beautifully how sometimes, understated details are best.



BROMSGROVE CABINET KNOB



Code	Width (W)	Projection (P)	Base (B)
BRGK/32	32mm	30mm	13mm

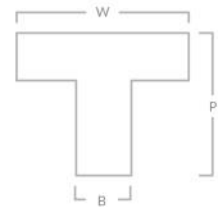

BROMSGROVE CABINET HANDLE



Code	Length (L)	Centres (C)	Projection (P)	Bar (Sq.)
BRG/45	45mm	35.5mm	31mm	9.5mm
BRG/96	106mm	96mm	31mm	9.5mm
BRG/128	138mm	128mm	31mm	9.5mm
BRG/203	213mm	203mm	32mm	9.5mm
BRG/305	318mm	305mm	42mm	12.7mm



BROMSGROVE APPLIANCE HANDLE



Code	Length (L)	Centres (C)	Projection (P)	Bar (Sq.)
BRG/APP/381	397mm	381mm	46mm	16mm
BRG/APP/608	624mm	608mm	46mm	16mm



Product photographed in our satin brass satin lacquered finish | In-situ photographed in our satin antique satin lacquered finish



Bromsgrove Cabinet Handle in our burnished brass finish

BROMWICH COLLECTION

Bromwich is an industrial collection of cabinet pulls expertly fitted onto separate backplates and streamlined flush pulls. The collection has a minimalistic edge and works beautifully in modern spaces.



BROMWICH FLUSH PULL



Code	Width (W)	Projection (P)	Height (H)	Centres (C)
BRW/FLUSH/110	110mm	13mm	64mm	85mm

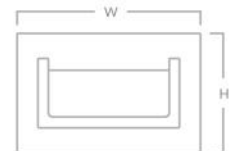

BROMWICH CABINET HANDLE



Code	Length (L)	Centres (C)	Projection (P)	Bar (Sq.)
BRW/45	62mm	35.5mm	35mm	9.5mm
BRW/96	122mm	96mm	35mm	9.5mm
BRW/128	154mm	128mm	35mm	9.5mm
BRW/203	233mm	203mm	37mm	9.5mm
BRW/305	339mm	305mm	47mm	12.7mm

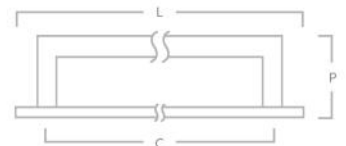

BROMWICH APPLIANCE HANDLE



Code	Length (L)	Centres (C)	Projection (P)	Bar (Sq.)
BRW/APP/381	415mm	381mm	51mm	16mm
BRW/APP/608	642mm	608mm	51mm	16mm



All product photographed in our burnished brass finish



Bromwich Cabinet Handle in our burnished brass finish

ARBAR COLLECTION

Designed to adorn the cabinetry of contemporary spaces, Arbar features a collection of sleek handles for modern kitchens and bathrooms.

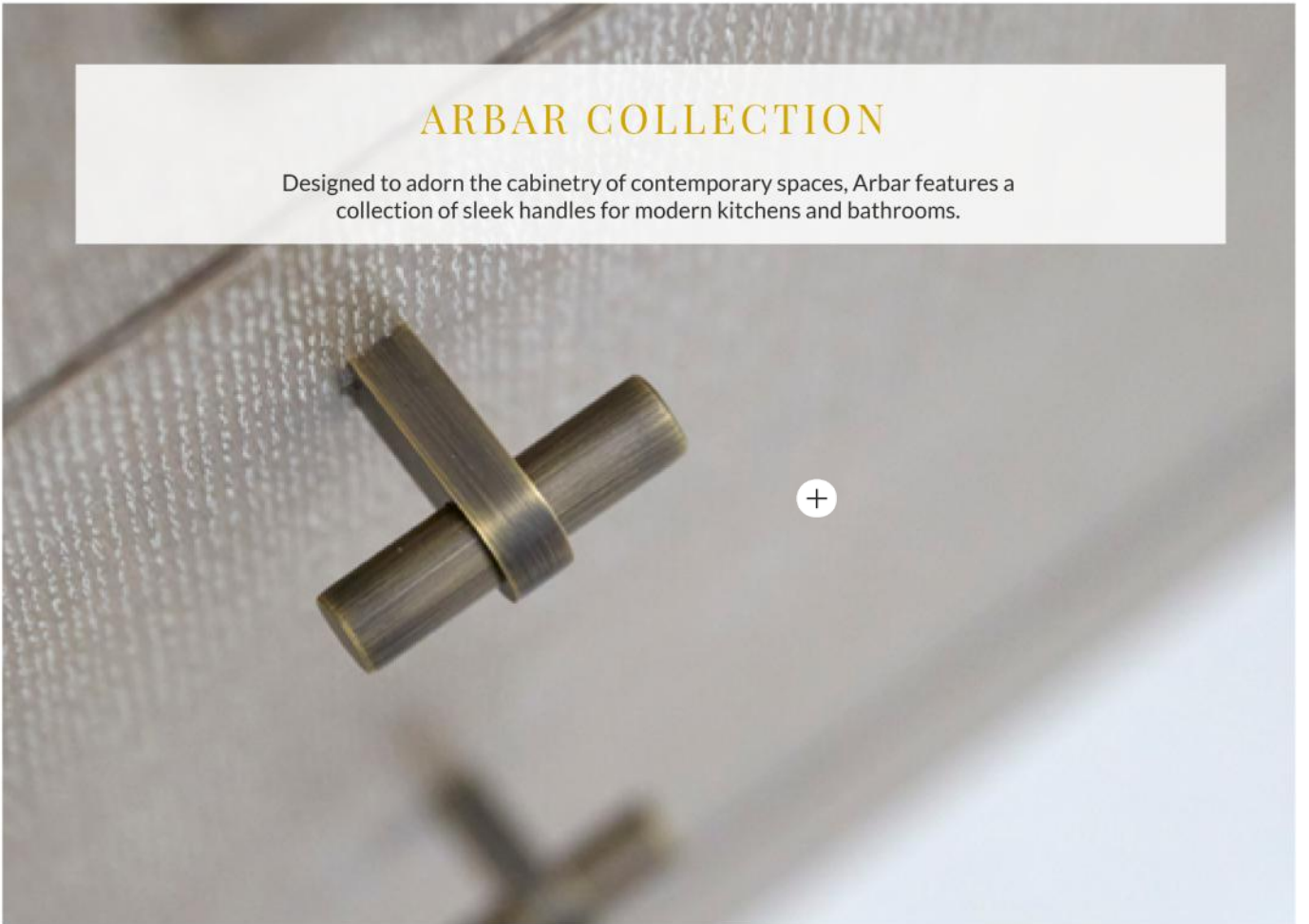

ARBAR CABINET KNOB



Code	Diameter (Dia.)	Projection (P)	Base (B)
ARBK/32	32mm	27mm	16mm
ARBK/38	38mm	31mm	17mm

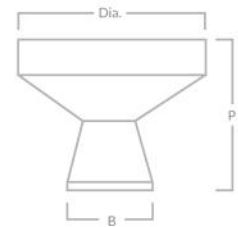

ARBAR T-BAR HANDLE



Code	Width (W)	Projection (P)	Bar Diameter
ARB/51	51mm	37mm	12.7mm

Not suitable for appliance doors

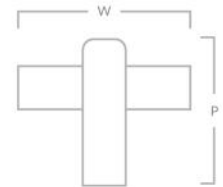

ARBAR CABINET & APPLIANCE HANDLE



Code	Length (L)	Centres (C)	Projection (P)	Bar Diameter
ARB/73	102mm	73mm	37mm	12.7mm
ARB/124	152mm	124mm	37mm	12.7mm
ARB/175	203mm	175mm	37mm	12.7mm
ARB/226	254mm	226mm	37mm	12.7mm
ARB/APP/368	416mm	368mm	56mm	19mm
ARB/APP/608	656mm	608mm	56mm	19mm



Product photographed in our burnished brass finish | In-situ photographed in our satin antique satin lacquered finish



Arbar T-Bar Handle in our satin antique satin lacquered finish

LEEBANK COLLECTION

Leebank is a covetable collection of luxury solid brass cabinet hardware with machined straight knurl design details.



LEEBANK CABINET KNOB



Code	Diameter (D)	Projection (P)	Base (B)
LEEK/32	32mm	32mm	24mm



LEEBANK T-BAR HANDLE



Code	Width (W)	Projection (P)	Base (B)	Bar Diameter
LEET/55	55mm	35mm	24mm	16mm

Not suitable for appliance doors

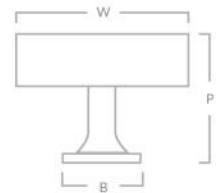

LEEBANK CABINET & APPLIANCE HANDLE



Code	Length (L)	Centres (C)	Projection (P)	Bar Diameter
LEE/128	168mm	128mm	33mm	12.7mm
LEE/160	210mm	160mm	36mm	14mm
LEE/224	274mm	224mm	36mm	14mm
LEE/288	338mm	288mm	36mm	14mm
LEE/APP/384	444mm	384mm	49mm	18mm
LEE/APP/608	668mm	608mm	49mm	18mm

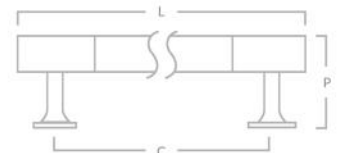

Product photographed in our satin antique satin lacquered finish | In-situ photographed in our burnished brass finish



Leebank Cabinet Handle in our burnished brass finish

SPARKBROOK COLLECTION

For spaces favouring subtle industrial design accents, Sparkbrook features a machined diamond knurl to give each solid brass cabinet handle its distinctive look.



SPARKBROOK CABINET KNOB



Code	Diameter (D)	Projection (P)	Base (B)
SPA/32	32mm	32mm	24mm

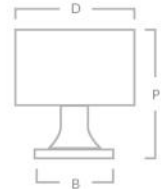

SPARKBROOK T-BAR HANDLE



Code	Width (W)	Projection (P)	Base (B)	Bar Diameter
SPAT/55	55mm	35mm	24mm	16mm

Not suitable for appliance doors

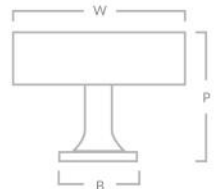

SPARKBROOK CABINET & APPLIANCE HANDLE



Code	Length (L)	Centres (C)	Projection (P)	Bar Diameter
SPA/128	168mm	128mm	33mm	12.7mm
SPA/160	210mm	160mm	36mm	14mm
SPA/224	274mm	224mm	36mm	14mm
SPA/288	338mm	288mm	36mm	14mm
SPA/APP/384	444mm	384mm	49mm	18mm
SPA/APP/608	668mm	608mm	49mm	18mm

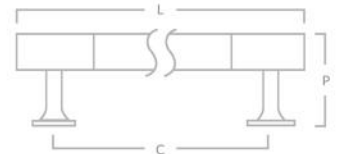

All product photographed in our satin brass satin lacquered finish



Sparkbrook Cabinet Handle in our satin antique satin lacquered finish

KINGSHEATH COLLECTION

Embracing a simple but significant design aesthetic, Kingsheath harnesses understated shapes to create a truly modern collection of solid brass hardware.



KINGSHEATH CABINET KNOB



Code	Diameter (D)	Projection (P)	Base (B)
KIN/32	32mm	32mm	24mm



KINGSHEATH T-BAR HANDLE



Code	Width (W)	Projection (P)	Base (B)	Bar Diameter
KINT/55	55mm	35mm	24mm	16mm

Not suitable for appliance doors

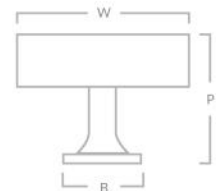

KINGSHEATH CABINET & APPLIANCE HANDLE



Code	Length (L)	Centres (C)	Projection (P)	Bar Diameter
KIN/128	168mm	128mm	33mm	12.7mm
KIN/160	210mm	160mm	36mm	14mm
KIN/224	274mm	224mm	36mm	14mm
KIN/288	338mm	288mm	36mm	14mm
KIN/APP/384	444mm	384mm	49mm	18mm
KIN/APP/608	668mm	608mm	49mm	18mm

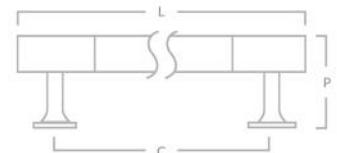

All product photographed in our burnished brass finish



Kingsheath Appliance Handle in our burnished brass finish

ROTUNDA COLLECTION

For deco inspired kitchens, opt for the Rotunda collection to extend the look to your cabinet hardware, expertly made from the finest solid brass.

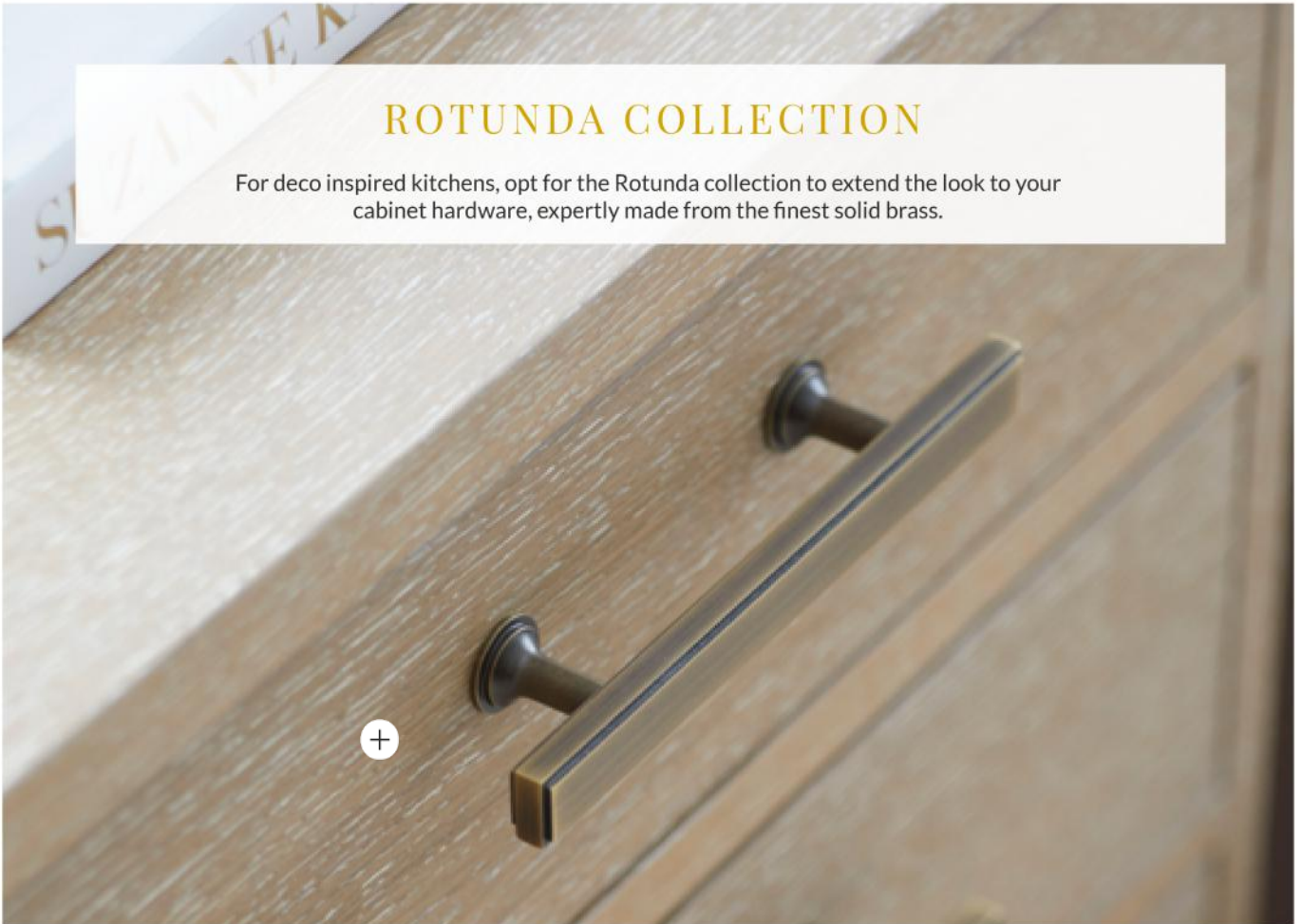

ROTUNDA CABINET KNOB



Code	Diameter (D)	Projection (P)	Base (B)
ROTK/25	25mm	24mm	15mm
ROTK/32	32mm	27mm	17mm
ROTK/38	38mm	30mm	20mm
ROTK/50	50mm	32mm	26mm

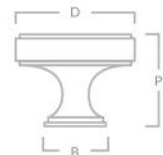

ROTUNDA CABINET HANDLE



Code	Length (L)	Centres (C)	Projection (P)	Bar Width
ROT/96	160mm	96mm	34mm	16mm x 9.5mm
ROT/128	192mm	128mm	34mm	16mm x 9.5mm
ROT/160	224mm	160mm	34mm	16mm x 9.5mm
ROT/224	288mm	224mm	34mm	16mm x 9.5mm
ROT/288	352mm	288mm	34mm	16mm x 9.5mm

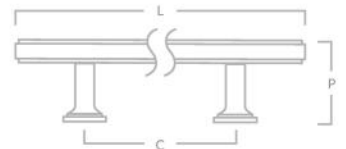

ROTUNDA APPLIANCE HANDLE



Code	Length (L)	Centres (C)	Projection (P)	Bar Width
ROT/APP/352	428mm	352mm	43mm	19mm x 12.7mm
ROT/APP/608	684mm	608mm	43mm	19mm x 12.7mm



Product photographed in our chocolate bronze finish | In-situ photographed in our satin antique satin lacquered finish

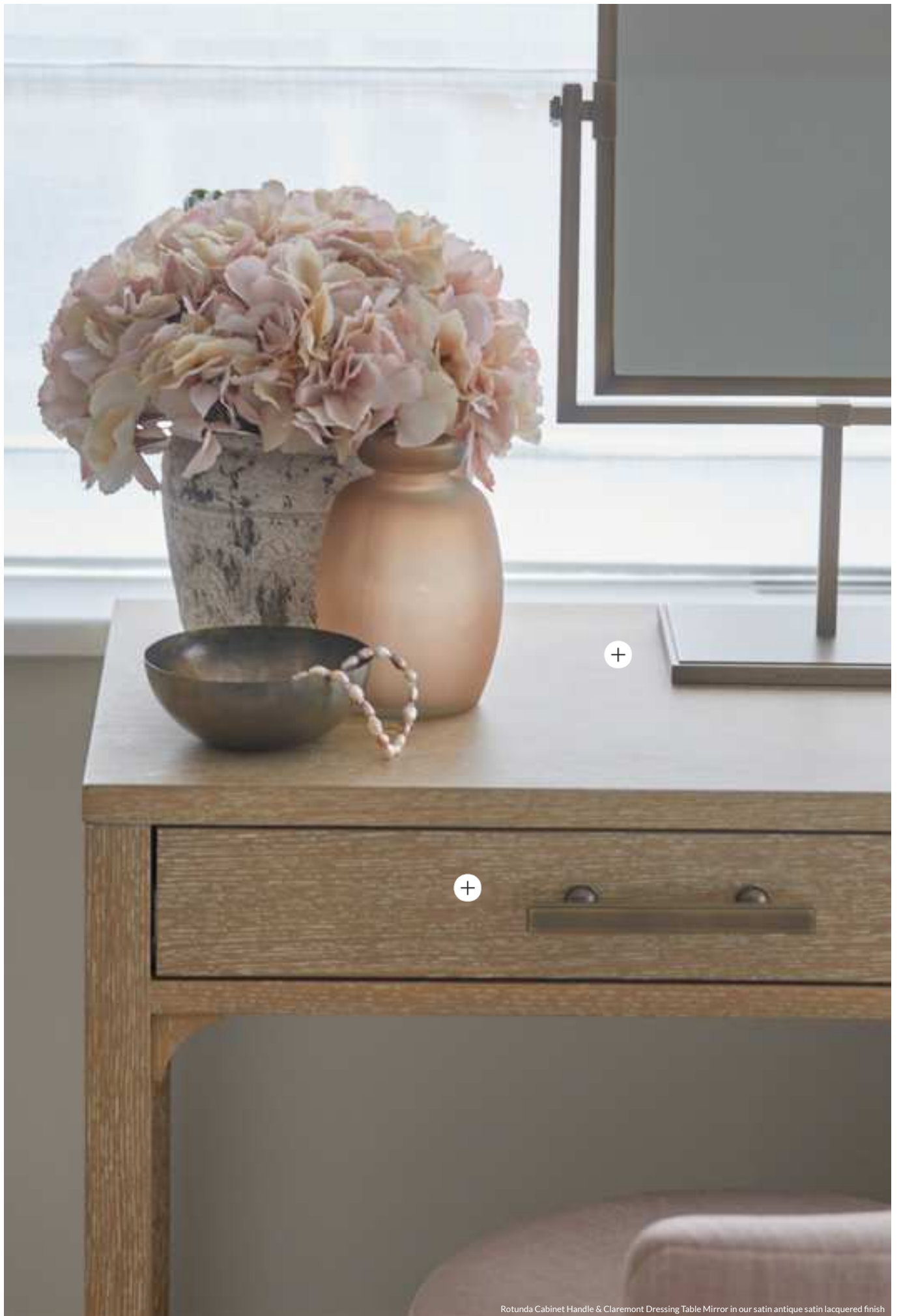

Rotunda Cabinet Handle & Claremont Dressing Table Mirror in our satin antique satin lacquered finish

GAUMONT COLLECTION

With a nod to the deco design era, Gaumont features a slight stepped edge to each piece of hardware.



GAUMONT T-BAR HANDLE



Code	Width (W)	Projection (P)	Base (B)	Bar Diameter
GAUT/64	64mm	36mm	18mm	12.7mm

Not suitable for appliance doors

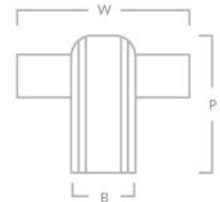

GAUMONT CABINET HANDLE



Code	Length (L)	Centres (C)	Projection (P)	Bar Diameter
GAU/96	150mm	96mm	36mm	12.7mm
GAU/128	182mm	128mm	36mm	12.7mm
GAU/160	214mm	160mm	36mm	12.7mm
GAU/224	278mm	224mm	36mm	12.7mm
GAU/304	358mm	304mm	36mm	12.7mm

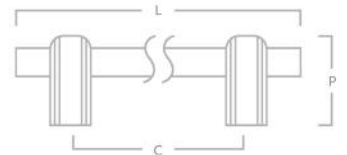

GAUMONT APPLIANCE HANDLE



Code	Length (L)	Centres (C)	Projection (P)	Bar Diameter
GAU/APP/368	430mm	368mm	54mm	19mm
GAU/APP/608	670mm	608mm	54mm	19mm



All product photographed in our satin antique satin lacquered finish



Gaumont Cabinet Handle & T-Bar in our satin antique satin lacquered finish

CARLTON COLLECTION

Yielding a subtle deco look, the Carlton collection features an elegant stepped edge to bring a little definition to each cabinet handle and knob.

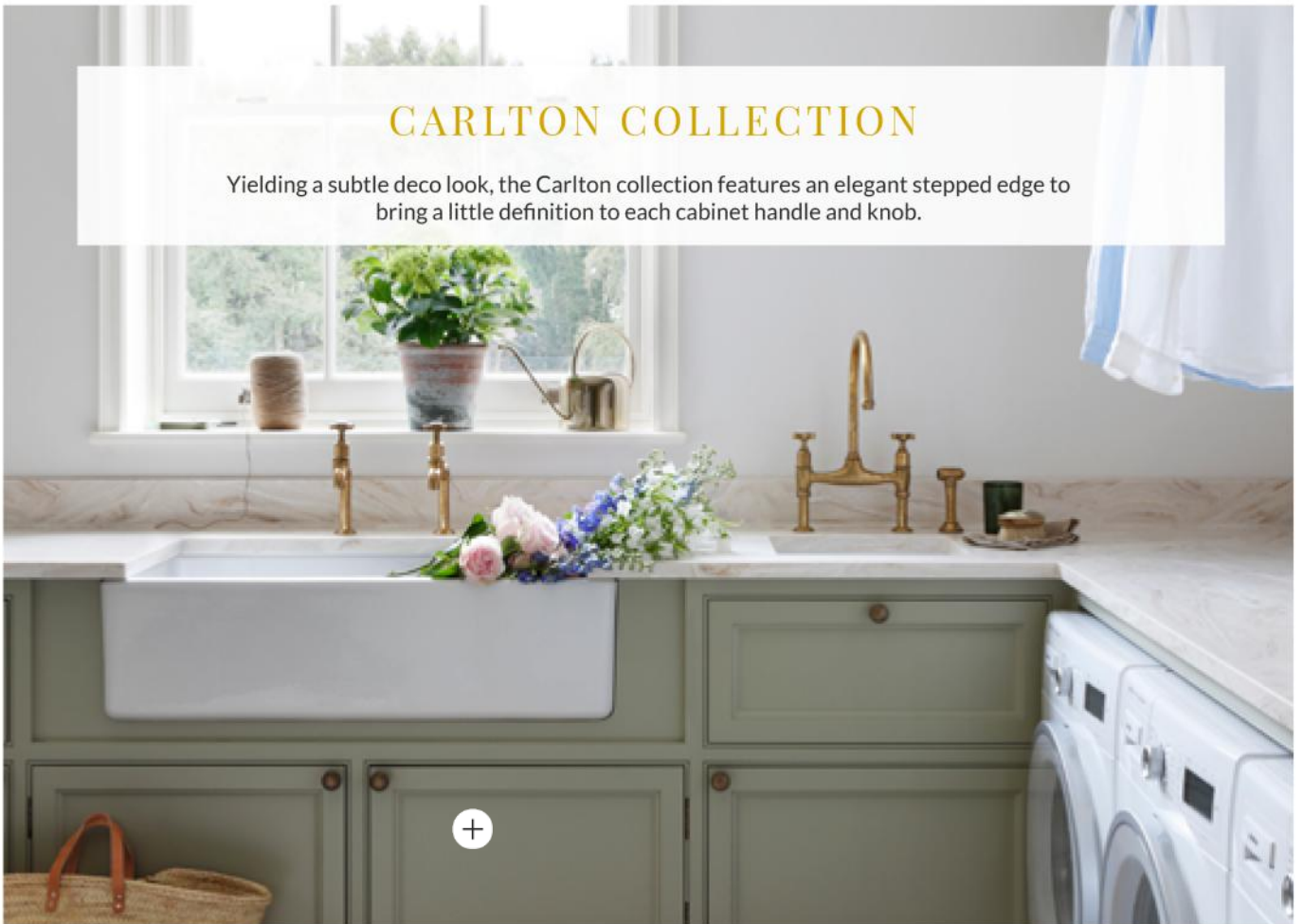

CARLTON CABINET KNOB



Code	Diameter (D)	Projection (P)	Base (B)
CARK/25	25mm	25mm	16mm
CARK/30	30mm	30mm	19mm
CARK/35	35mm	35mm	22mm



CARLTON CABINET HANDLE



Code	Length (L)	Centres (C)	Projection (P)	Bar Diameter
CAR/96	114mm	96mm	36mm	12.7mm
CAR/128	146mm	128mm	36mm	12.7mm
CAR/160	178mm	160mm	36mm	12.7mm
CAR/224	242mm	224mm	36mm	12.7mm
CAR/304	322mm	304mm	36mm	12.7mm

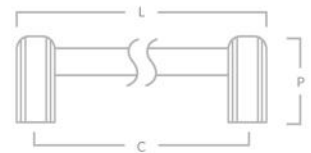

CARLTON APPLIANCE HANDLE



Code	Length (L)	Centres (C)	Projection (P)	Bar Diameter
CAR/APP/368	395mm	368mm	54mm	19mm
CAR/APP/608	635mm	608mm	54mm	19mm



Product photographed in our burnished brass finish | In-situ photographed in our satin antique satin lacquered finish



Carlton Cabinet Knob, Carlton Cabinet Handle, Gaumont T-Bar Handle, 0180 Coat & Hat Hook in our burnished brass finish & Medium Cross Grille in our bronze metal antique finish

DOUGAN COLLECTION

Presenting a beautiful blend of style and sophistication, Dougan takes inspiration from the deco design era. Opt for a backplate to make a statement or without for a refined and elegant look.



DOUGAN CABINET KNOB



Code	Diameter (D)	Projection (P)	Base (B)
DOUK/25	25mm	23mm	19mm
DOUK/32	32mm	29mm	24mm
DOUK/38	38mm	34mm	28mm

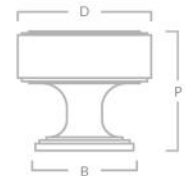

DOUGAN CABINET & APPLIANCE HANDLE



Code	Length (L)	Centres (C)	Projection (P)	Bar Width
DOU/PULLONLY/96	107mm	96mm	33mm	16mm x 11mm
DOU/PULLONLY/160	171mm	160mm	33mm	16mm x 11mm
DOU/PULLONLY/224	235mm	224mm	33mm	16mm x 11mm
DOU/PULLONLY/APP/320	333mm	320mm	45mm	18mm x 13mm
DOU/PULLONLY/APP/608	621mm	608mm	45mm	18mm x 13mm

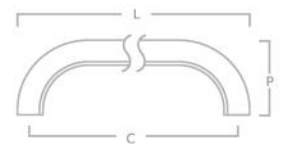

DOUGAN CABINET & APPLIANCE HANDLE WITH BACKPLATE



Code	Length (L)	Centres (C)	Projection (P)	Base Width	Bar Width
DOU/96	123mm	96mm	38mm	32mm	16mm x 11mm
DOU/160	187mm	160mm	38mm	32mm	16mm x 11mm
DOU/224	251mm	224mm	38mm	32mm	16mm x 11mm
DOU/APP/320	352mm	320mm	49mm	38mm	18mm x 13mm
DOU/APP/608	640mm	608mm	49mm	38mm	18mm x 13mm

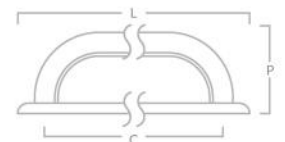

Product photographed in our satin antique satin lacquered finish | In-situ photographed in our burnished brass finish



Dougan Cabinet Knob in our burnished brass finish

JEFFERSON COLLECTION

Inspired by the deco design era, Jefferson is a solid brass collection of cabinet hardware covetable for its angular edges and stepped design.



JEFFERSON CABINET KNOB



Code	Width (W)	Projection (P)	Stem (S)	Base (B)
JEFK/25	25mm	29mm	20mm	19mm
JEFK/32	32mm	33mm	20mm	24mm
JEFK/38	38mm	33mm	20mm	24mm

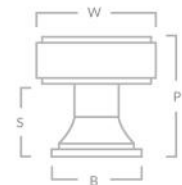

JEFFERSON CABINET HANDLE



Code	Length (L)	Centres (C)	Projection (P)	Stem (S)	Bar Width
JEF/96	109mm	96mm	30mm	20mm	12.7mm x 9.5mm
JEF/102	126mm	102mm	30mm	20mm	16mm x 9.5mm
JEF/152	176mm	152mm	30mm	20mm	16mm x 9.5mm
JEF/203	227mm	203mm	30mm	20mm	16mm x 9.5mm
JEF/305	335mm	305mm	40mm	27mm	19mm x 12.7mm

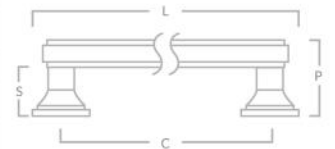

JEFFERSON APPLIANCE HANDLE



Code	Length (L)	Centres (C)	Projection (P)	Stem (S)	Bar Width
JEF/APP/368	398mm	368mm	40mm	27mm	19mm x 12.7mm
JEF/APP/608	638mm	608mm	40mm	27mm	19mm x 12.7mm



Product photographed in our satin antique satin lacquered finish | In-situ photographed in our chocolate bronze finish

LINCOLN COLLECTION

Add a touch of finesse to your cabinetry with the Lincoln collection. Showcasing a truly timeless look, the luxury solid brass handles feature an elegant form with stepped edges accentuating the design.



LINCOLN CABINET KNOB



Code	Projection (P)	Diameter (D)	Base (B)
LINK/25	20mm	25mm	16mm
LINK/32	26mm	32mm	20mm
LINK/38	30mm	38mm	24mm

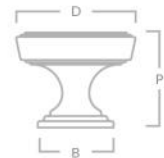

LINCOLN T-BAR HANDLE



Code	Width (W)	Projection (P)	Base (B)	Bar Diameter
LINT/82	82mm	34mm	24mm	12.7mm

Not suitable for appliance doors

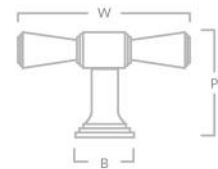

LINCOLN CABINET & APPLIANCE HANDLE



Code	Length (L)	Centres (C)	Projection (P)	Bar Diameter
LIN/96	186mm	96mm	35mm	12.7mm
LIN/128	218mm	128mm	35mm	12.7mm
LIN/224	361mm	224mm	42mm	16mm
LIN/APP/304	470mm	304mm	49mm	19mm
LIN/APP/608	774mm	608mm	49mm	19mm



All product photographed in our satin antique satin lacquered finish

SUTTON COLLECTION

A luxury hardware collection that caters to both classic and contemporary interior styles, Sutton features sleek circular grooves to bring definition to timeless designs.



SUTTON CABINET KNOB



Code	Diameter (D)	Projection (P)	Base (B)
SUTK/25	25mm	25mm	16mm
SUTK/32	32mm	29mm	21mm
SUTK/38	38mm	33mm	25mm
SUTK/50	50mm	33mm	27mm

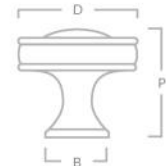

SUTTON CABINET HANDLE



Code	Length (L)	Centres (C)	Projection (P)	Bar Diameter
SUT/96	160mm	96mm	39mm	16mm
SUT/128	192mm	128mm	39mm	16mm
SUT/160	224mm	160mm	39mm	16mm
SUT/224	305mm	224mm	46mm	19mm

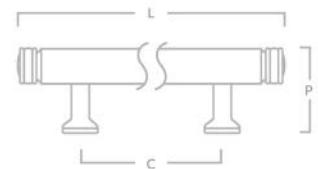

SUTTON APPLIANCE HANDLE



Code	Length (L)	Centres (C)	Projection (P)	Bar Diameter
SUT/APP/368	438mm	368mm	49mm	19mm
SUT/APP/608	678mm	608mm	49mm	19mm



Product photographed in our chocolate bronze finish | In-situ photographed in our burnished brass finish



Sutton Cabinet Knob in our antique brass lacquered finish

QUESLETT COLLECTION

Presenting a beautiful blend of form and function, Queslett has a classic New England look perfect for kitchen and utility cabinets.



QUESLETT CABINET KNOB



Code	Diameter (D)	Projection (P)	Base (B)
QK/KNOBONLY/34	34mm	32mm	12mm

QUESLETT CABINET KNOB WITH SQUARE BACKPLATE

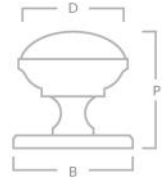

Code	Diameter (D)	Base Plate (B)	Projection (P)
QK/34	34mm	38x38mm	36mm

QUESLETT CUP PULL



Code	Height (H)	Length (L)	Centres (C)	Projection (P)
Q40	40mm	64mm	40mm	22mm
Q96	40mm	108mm	96mm	22mm
Q120	40mm	160mm	120mm	22mm
Q203	40mm	229mm	203mm	22mm

QUESLETT CABINET KNOB WITH RECTANGULAR BACKPLATE

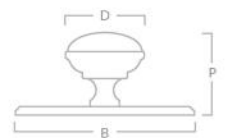

Code	Diameter (D)	Base Plate (B)	Projection (P)
QKR/34	34mm	38x76mm	36mm

Product photographed in our burnished brass finish | In-situ photographed in our polished brass unlacquered finish



Queslett Cabinet Knob with Square Backplate, Queslett Cabinet Knob with Rectangular Backplate & Queslett Finger Pull in our satin brass lacquered finish

WASHWOOD COLLECTION

Designed with smooth shapes, Washwood features a classic selection of stylish solid brass hardware to accentuate your interior cabinetry.



WASHWOOD CABINET KNOB



Code	Diameter (D)	Projection (P)	Base (B)
WAS/KNOBONLY/35	35mm	32mm	18mm

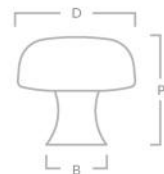

WASHWOOD CABINET KNOB WITH BACKPLATE



Code	Width (W)	Height	Projection (P)	Centres (C)	Knob Diameter
WASK/35	60mm	38mm	37mm	44mm	35mm

Knob has both front and rear fixings

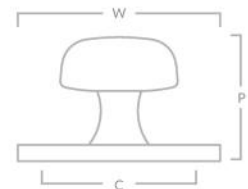

WASHWOOD CABINET & APPLIANCE HANDLE



Code	Centres (C)	Length (L)	Projection (P)	Bar Width
WAS/96	96mm	109mm	27mm	13mm x 7mm
WAS/152	152mm	170mm	35mm	17mm x 9mm
WAS/224*	224mm	246mm	45mm	22mm x 12mm
WAS/APP/384*	359mm	384mm	52mm	25mm x 14mm

*Pulls have both front and rear fixings

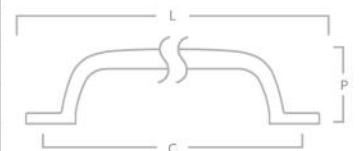

Product photographed in our satin antique satin lacquered finish | In-situ photographed in our polished brass unlacquered finish



Washwood Cabinet Knob & Washwood Cabinet Handle in our polished brass unlacquered finish

COTSWOLD COLLECTION

Inspired by the traditional beauty of the Cotswold villages, Cotswold is a timeless range of luxury solid brass hardware that takes note from the iconic English countryside.

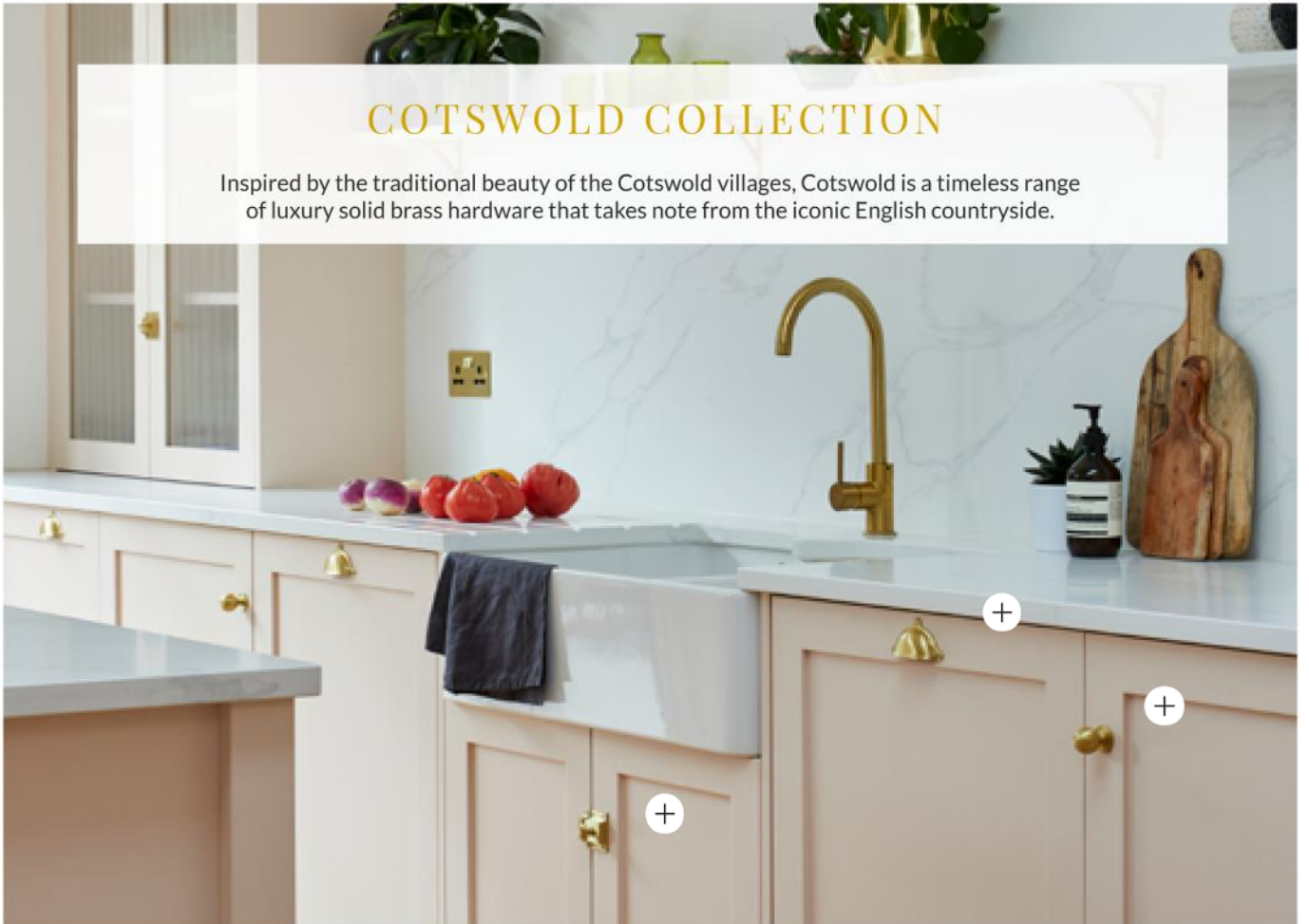

COTSWOLD BALL KNOB



Code	Diameter (D)	Projection (P)	Base (B)
COTK/BALL/19	19mm	30mm	19mm
COTK/BALL/25	25mm	37mm	26mm
COTK/BALL/32	32mm	44mm	32mm
COTK/BALL/38	38mm	55mm	38mm



COTSWOLD MUSHROOM KNOB



Code	Diameter (D)	Projection (P)	Base (B)
COTK/MUSH/19	19mm	25mm	19mm
COTK/MUSH/25	25mm	29mm	26mm
COTK/MUSH/32	32mm	33mm	32mm
COTK/MUSH/38	38mm	38mm	38mm



COTSWOLD BUN KNOB



Code	Diameter (D)	Projection (P)	Base (B)
COTK/BUN/19	19mm	19mm	21mm
COTK/BUN/25	25mm	26mm	27mm
COTK/BUN/32	32mm	33mm	32mm
COTK/BUN/38	38mm	37mm	38mm



Product photographed in our burnished brass finish | In-situ photographed in our satin brass lacquered finish

COTSWOLD CUP PULL



Code	Width (W)	Centres (C)	Height (H)	Projection
COT/PULL/56/RF	56mm	38mm	32mm	18mm
COT/PULL/92/RF	92mm	76mm	41mm	20mm

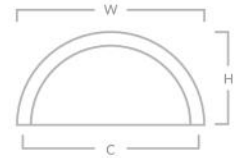

COTSWOLD DRAWER PULL



Code	Width (W)	Height (H)	Projection
COT/PULL/FF	98mm	49mm	20mm



COTSWOLD CABINET HANDLE



Code	Width (W)	Height (H)	Centres (C)
COT/CAB/76	107mm	53mm	76mm
COT/CAB/89	125mm	58mm	89mm
COT/CAB/102	140mm	63mm	102mm

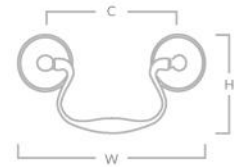

COTSWOLD CUPBOARD TURN



Code	Height (H)	Width (W)	Projection (P)
COT/TURN/38	54mm	38mm	34mm



COTSWOLD CUPBOARD LATCH



Code	Height (H)	Width (W)	Projection (P)
COT/LATCH	55mm	50mm	32mm

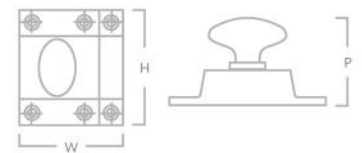

COTSWOLD THUMB LATCH



Code	Width (W)	Height (H)	Projection (P)
COT/THUMB	34mm	39mm	40mm

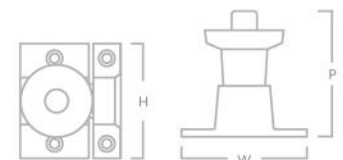

Product photographed in our burnished brass finish



Cotswold Cup Pull & Cotswold Cupboard Latch in our burnished brass finish



Cotswold Drawer Pull & Cotswold Ball Knob in our polished brass unlacquered finish

WITHENSHAW COLLECTION

Showcasing classic charm, Withenshaw is a traditional collection of solid brass hardware suited to shaker style kitchens. With smooth curves, each piece is designed to bring character to your kitchen doors and drawers.



WITHENSHAW CABINET KNOB



Code	Diameter (D)	Projection (P)	Base (B)
WITK/32	32mm	32mm	24mm
WITK/38	38mm	39mm	28mm

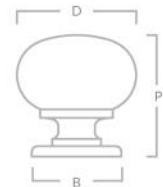

WITHENSHAW CUP PULL



Code	Length (L)	Centres (C)	Projection (P)	Height (H)
WIT/96	127mm	96mm	22mm	41mm
WIT/192	224mm	192mm	22mm	41mm

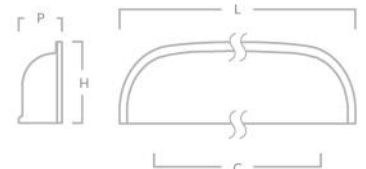



Withenshaw Cabinet Knob in our burnished brass finish

BAKES COLLECTION

Designed by leading kitchen designer Robert Bakes, the Bakes collection presents fluid edges to bring an effortless look and feel to your cabinetry.



BAKES CABINET KNOB

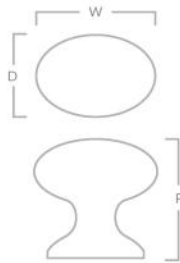

Code	Depth (D)	Width (W)	Projection (P)
BBFK01	38mm	51mm	35mm
BBFK02	32mm	45mm	30mm
BBFK03	23mm	32mm	22mm

BAKES CABINET & APPLIANCE HANDLE

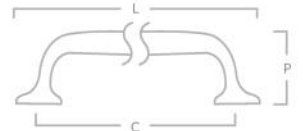

Code	Length (L)	Centres (C)	Projection (P)	Bar Width
BBF01	375mm	320mm	51mm	28mm x 13mm
BBF02	244mm	203mm	38mm	18mm x 13mm
BBF03	182mm	152mm	31mm	14mm x 10mm
BBF04	153mm	127mm	26mm	12mm x 9mm
BBF05	126mm	102mm	26mm	10mm x 8mm

BAKES FLUSH LATCH

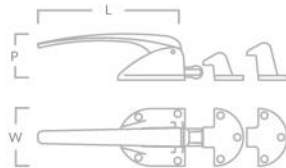

Code	Latch (L)	Width (W)	Projection (P)
BBF/LATCH/FLUSH	150mm	58mm	47mm
BBF/LATCH/OFFSET	150mm	58mm	47mm

Offset latch has 9.5mm offset

All product photographed in our burnished brass finish

BAKES HINGE

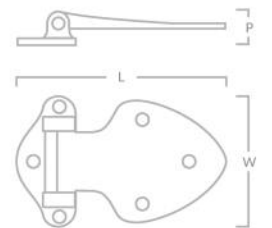

Hinge Code	Width (W)	Length (L)	Projection (P)
BBF/HINGE	76mm	120mm	21mm

Offset hinge has 9.5mm offset



Bakes Cabinet Handle & Bakes Cabinet Knob in our burnished brass finish

BELGRAVE COLLECTION

Stylish and sophisticated, bring harmony to luxury design schemes with Belgrave. The elegant designs of the Belgrave collection work beautifully in opulent styled settings.



BELGRAVE CABINET KNOB



Code	Diameter (D)	Projection (P)	Base (B)
BELK/25	25mm	29mm	15mm
BELK/32	32mm	36mm	19mm
BELK/38	38mm	43mm	22mm



BELGRAVE T-BAR HANDLE



Code	Width (W)	Projection (P)	Base (B)
BELT/61	61mm	49mm	22mm

Not suitable for appliance doors

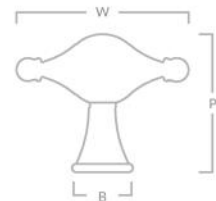

BELGRAVE CABINET & APPLIANCE HANDLE



Code	Length (L)	Centres (C)	Projection (P)	Bar Diameter
BEL/128	177mm	128mm	40mm	12.7mm
BEL/160	208mm	160mm	40mm	12.7mm
BEL/192	240mm	192mm	40mm	12.7mm
BEL/256	317mm	256mm	50mm	16mm
BEL/384	445mm	384mm	50mm	16mm
BEL/APP/448	521mm	448mm	57mm	19mm
BEL/APP/608	681mm	608mm	57mm	19mm

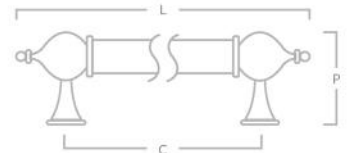

Product photographed in our chocolate bronze finish | In-situ photographed in our satin antique satin lacquered finish

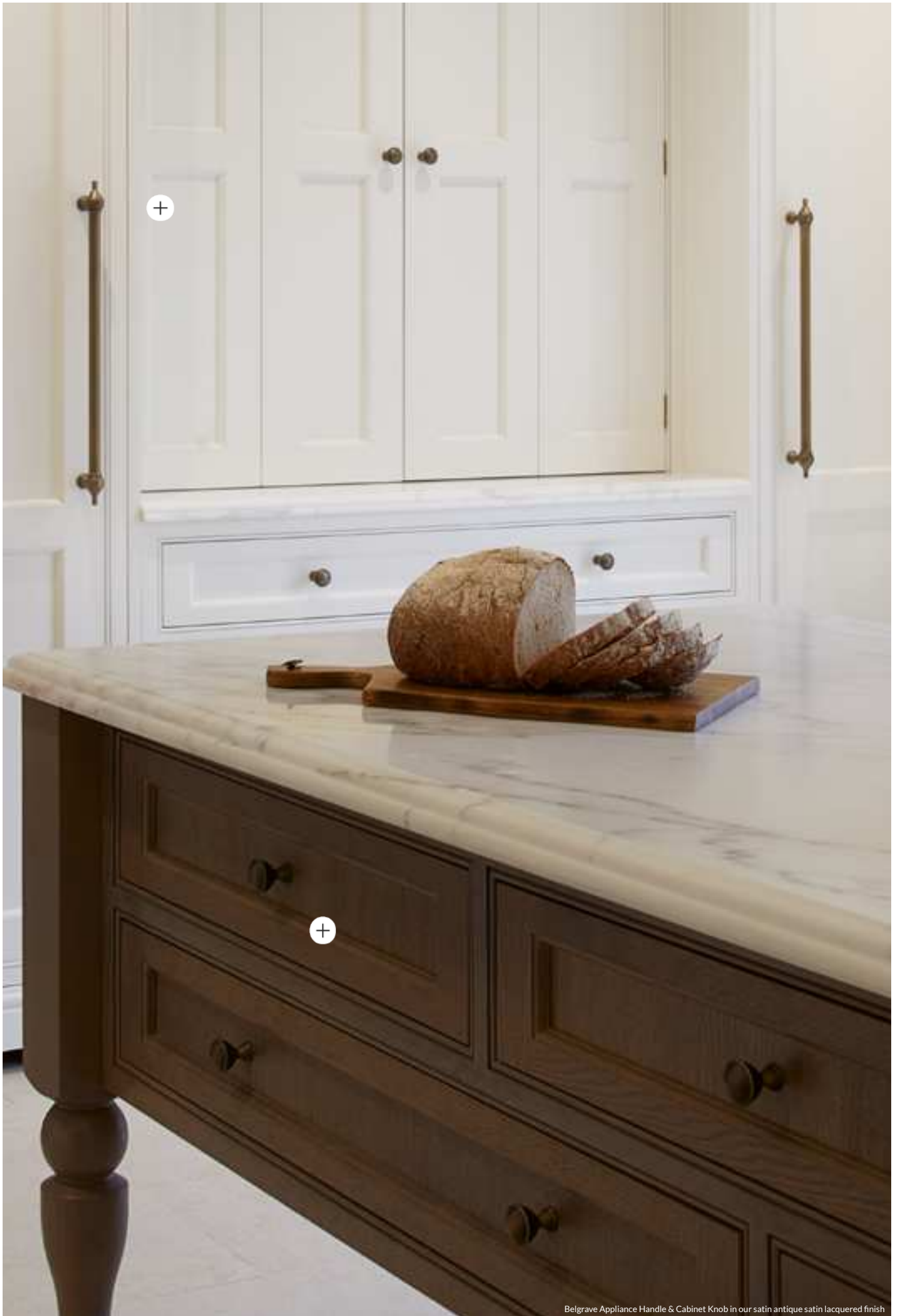

Belgrave Appliance Handle & Cabinet Knob in our satin antique satin lacquered finish



LATCHFORD COLLECTION

Expertly machined from the finest solid brass, Latchford nods to a more traditional design with a curved and flawless aesthetic.

LATCHFORD CABINET KNOB



Code	Diameter (D)	Projection (P)	Base (B)
LATK/25	25mm	38mm	25mm
LATK/30	30mm	45mm	30mm
LATK/35	35mm	53mm	35mm



LATCHFORD CABINET HANDLE



Code	Length (L)	Centres (C)	Projection (P)	Bar Diameter
LAT/96	202mm	96mm	39mm	16mm
LAT/128	234mm	128mm	39mm	16mm
LAT/160	266mm	160mm	39mm	16mm
LAT/224	330mm	224mm	39mm	16mm
LAT/288	394mm	288mm	39mm	16mm

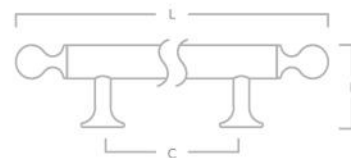

LATCHFORD APPLIANCE HANDLE



Code	Length (L)	Centres (C)	Projection (P)	Bar Diameter
LAT/APP/368	479mm	368mm	49mm	19mm
LAT/APP/608	719mm	608mm	49mm	19mm



Product photographed in our burnished brass finish | In-situ photographed in our polished brass lacquered finish

MERRICK COLLECTION

Showcasing a sophisticated reeded design, Merrick is a traditional inspired collection of cabinet hardware that will add instant texture to your space.

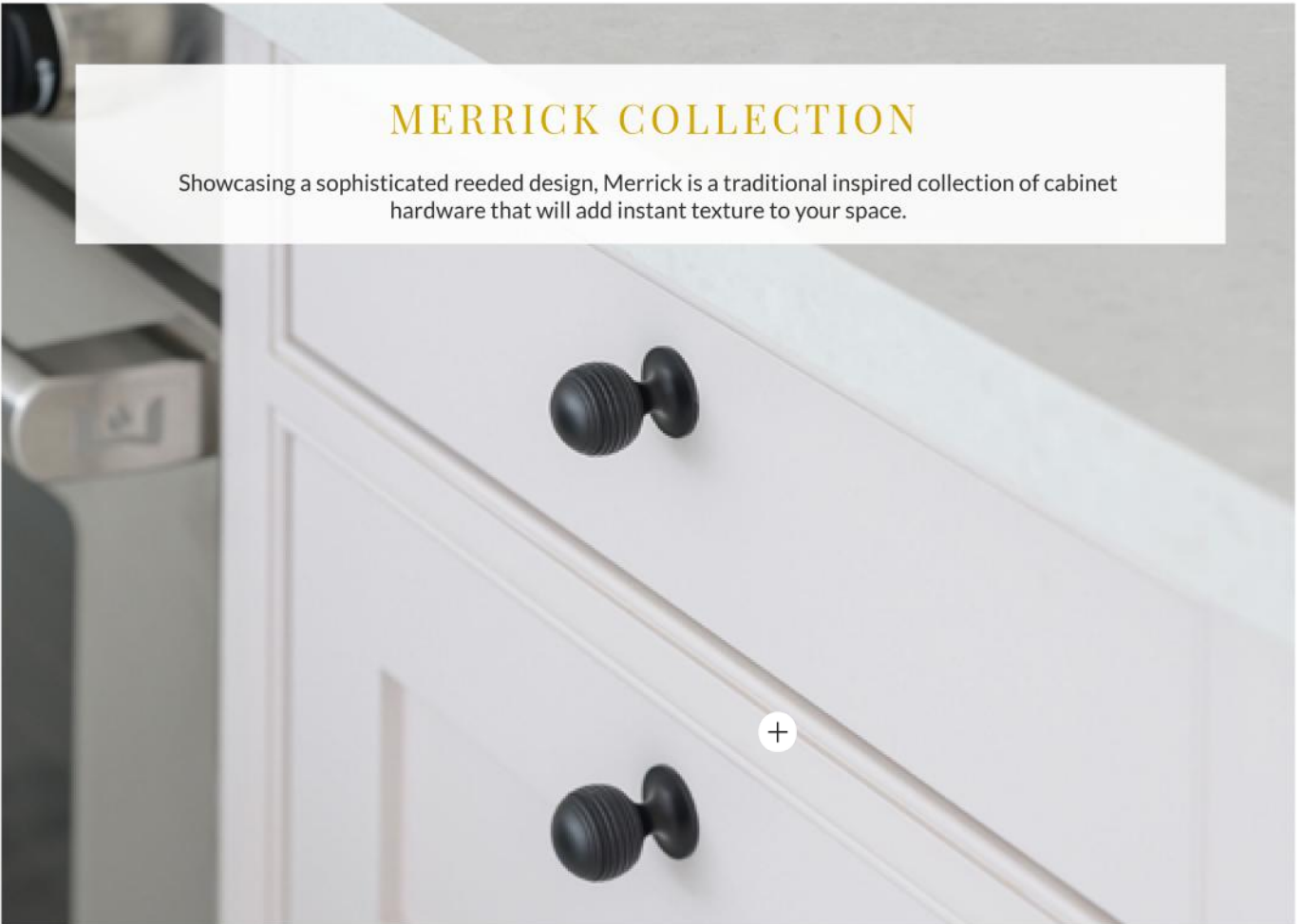

MERRICK CABINET KNOB



Code	Diameter (D)	Projection (P)	Base (B)
MERK/19	19mm	28mm	19mm
MERK/25	25mm	38mm	25mm
MERK/32	32mm	43mm	32mm
MERK/38	38mm	53mm	38mm

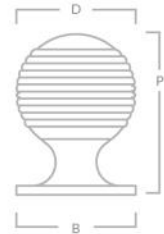

MERRICK CABINET HANDLE



Code	Length (L)	Centres (C)	Projection (P)	Bar Diameter
MER/96	202mm	96mm	39mm	16mm
MER/128	234mm	128mm	39mm	16mm
MER/160	266mm	160mm	39mm	16mm
MER/224	330mm	224mm	39mm	16mm
MER/288	394mm	288mm	39mm	16mm

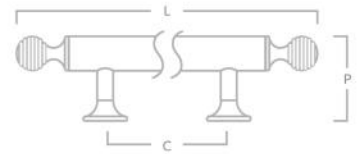

MERRICK APPLIANCE HANDLE



Code	Length (L)	Centres (C)	Projection (P)	Bar Diameter
MER/APP/368	478mm	368mm	49mm	19mm
MER/APP/608	718mm	608mm	49mm	19mm

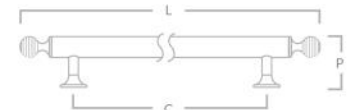

Product photographed in our satin brass satin lacquered finish | In-situ photographed in our matt black finish

SNOWDRIFT COLLECTION

Add a softness to your spaces with the curved contours of Snowdrift. A minimalistic collection of luxury hardware that promises to add subtle impact.

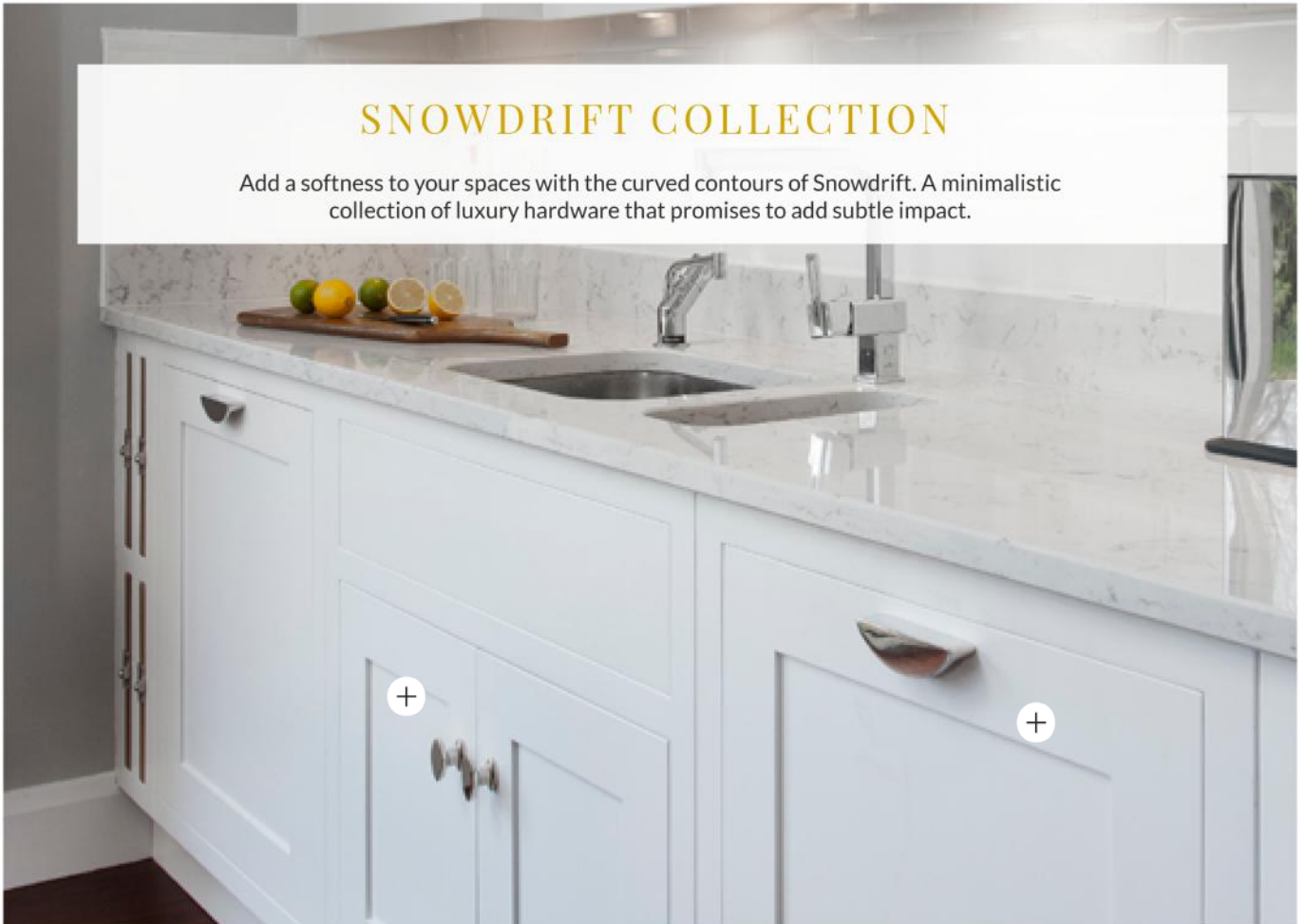

SNOWDRIFT CABINET KNOB



Code	Width (W)	Projection (P)	Base (B)	Depth (D)
DRFTK	46mm	30mm	36x19mm	27mm

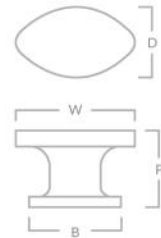

SNOWDRIFT CABINET PULL



Code	Length (L)	Centres (C)	Height (H)	Projection (P)
DRFT/107	107mm	64mm	32mm	25mm
DRFT/187	187mm	160mm	36mm	25mm
DRFT/280	280mm	224mm	40mm	25mm

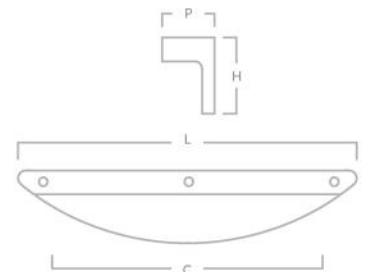

BOURNVILLE COLLECTION

Enhance the look of your kitchen cabinetry with the Bournville collection. This sleek hardware range is a diverse option that works beautifully across an array of spaces.



BOURNVILLE CABINET KNOB



Code	Width (W)	Projection (P)	Base (B)
BNVK/35	35mm	22mm	22mm
BNVK/51	51mm	32mm	32mm

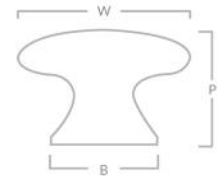

BOURNVILLE CABINET HANDLE



Code	Length (L)	Centres (C)	Projection (P)
BNV/86	100mm	86mm	30mm
BNV/160	178mm	160mm	38mm
BNV/254	279mm	254mm	50mm

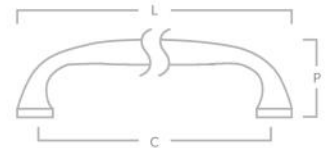

BOURNVILLE APPLIANCE HANDLE



Code	Length (L)	Centres (C)	Projection (P)
BNV/APP/330	360mm	330mm	61mm



Product photographed in our burnished brass finish | In-situ photographed in our satin antique satin lacquered finish

ABERDOVEY COLLECTION

Showcasing elegant shell-style curves, Aberdovey is a traditional collection of luxury solid brass knobs and cup pulls suited to interiors with a classic coastal feel.



ABERDOVEY CABINET KNOB



Code	Width (W)	Projection (P)	Base (B)
ABDK/32	32mm	27mm	15mm
ABDK/38	38mm	35mm	15mm

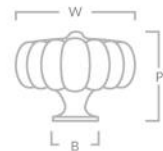

ABERDOVEY DRAWER PULL



Code	Width (W)	Height (H)	Projection
ABD/PULL/FF	102mm	48mm	25mm

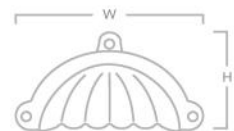

ABERDOVEY SHELL CUP PULL



Code	Width (W)	Height (H)	Projection	Centres (C)
ABD/PULL/RF	92mm	36mm	25mm	76mm

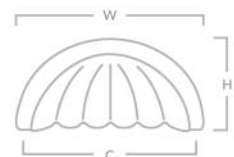

Product photographed in our satin antique satin lacquered finish | In-situ photographed in our satin brass lacquered finish



Aberdovey Drawer Pull & Cotswold Bun Knob in our satin brass lacquered finish

EDGBASTON COLLECTION

Go back to basics with Edgbaston and discover a contemporary collection of linear cabinet pull handles named after one of the most desirable boroughs in Birmingham.

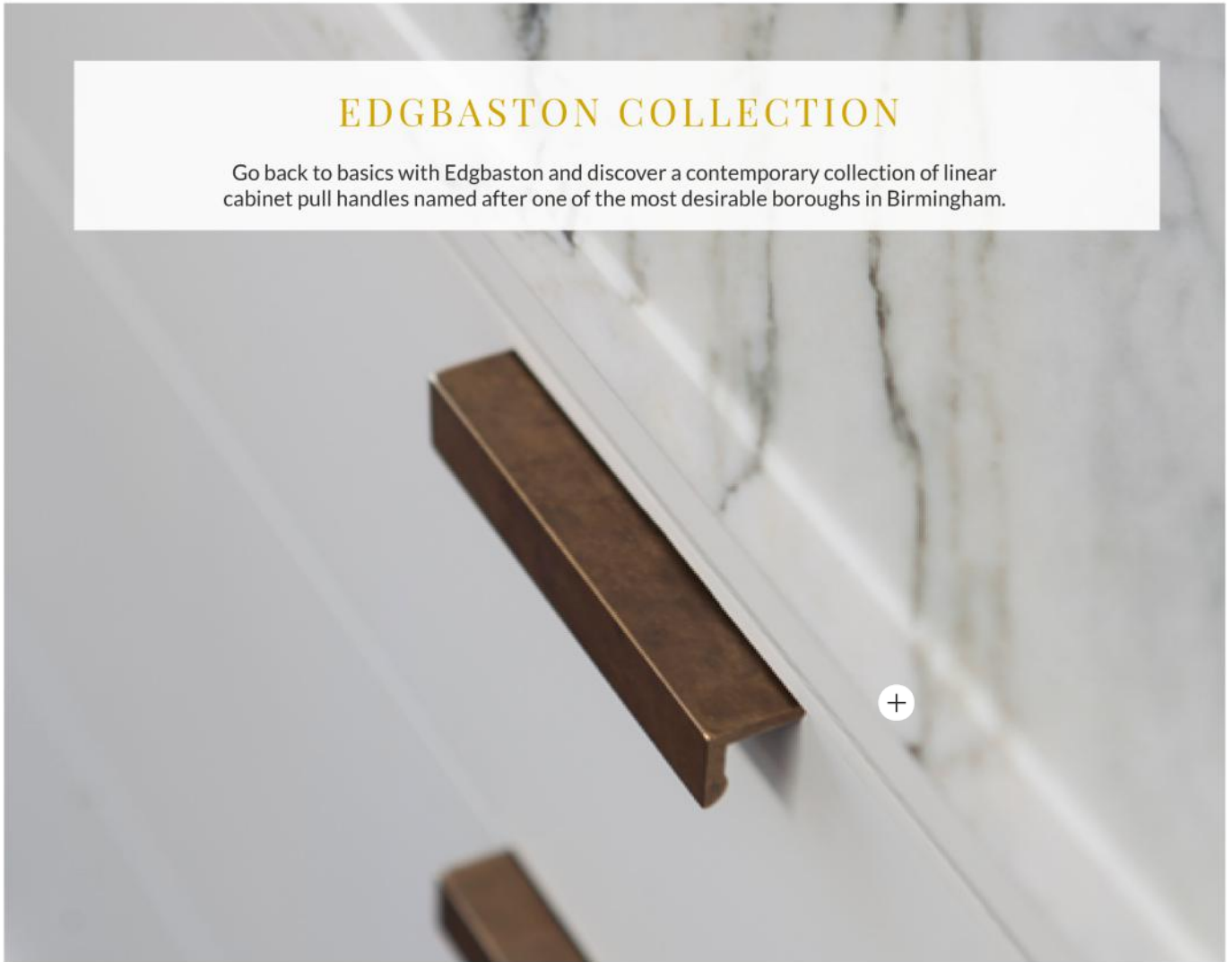

EDGBASTON CABINET PULL

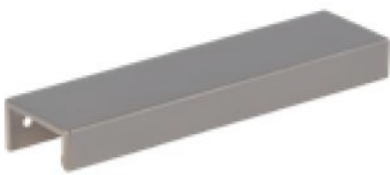

Code	Length (L)	Centres (C)	Height (H)	Projection (P)
EDG/50	50mm	32mm	25mm	48mm
EDG/110	110mm	96mm	25mm	48mm
EDG/180	180mm	160mm	25mm	48mm
EDG/312	312mm	288mm	25mm	48mm
EDG/400	400mm	368mm (plus centre hole)	25mm	48mm
EDG/500	500mm	464mm (plus centre hole)	25mm	48mm

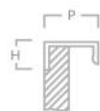



Edgbaston Cabinet Pull & Leebank T-Bar Handle in our burnished brass finish

QUINTON COLLECTION

Inspired by Mondrian's iconic Cubism era, Quinton is a modern collection of extruded cabinet pulls.



QUINTON CABINET PULL

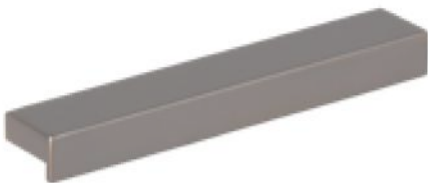

Code	Height (H)	Length (L)	Centres (C)	Projection (P)
QNT/50	16mm	50mm	32mm	25mm
QNT/120	16mm	120mm	96mm	25mm
QNT/150	16mm	150mm	128mm	25mm
QNT/312	16mm	312mm	288mm	25mm
QNT/400	16mm	400mm	368mm (plus centre hole)	25mm
QNT/500	16mm	500mm	464mm (plus centre hole)	25mm

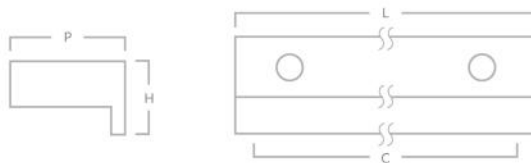

Product photographed in our chocolate bronze finish | In-situ photographed in our satin antique satin lacquered finish



Quinton Cabinet Pull in our matt black lacquered finish

JASPETTE COLLECTION

Minimalist linear shapes effortlessly form the design for the Jaspette collection. Made from solid brass, each contemporary pull handle may be fitted vertically or horizontally.

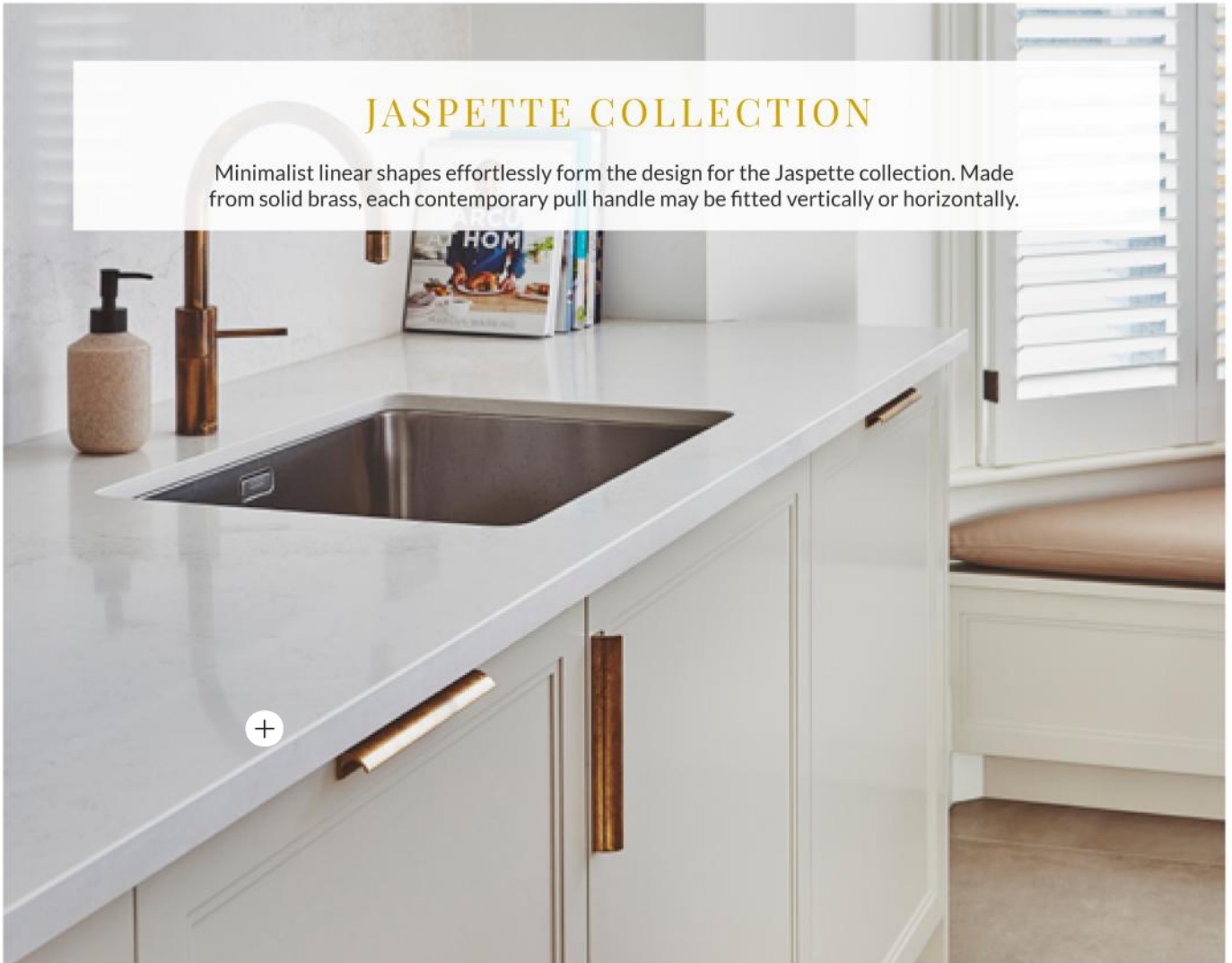

JASPETTE CABINET PULL



Code	Length (L)	Centres (C)	Height (H)	Projection (P)
JPT/50	50mm	32mm	19mm	22mm
JPT/110	110mm	96mm	19mm	22mm
JPT/180	180mm	160mm	19mm	22mm
JPT/310	310mm	290mm (plus centre hole)	19mm	22mm
JPT/400	400mm	368mm (plus centre hole)	19mm	22mm
JPT/500	500mm	448mm (plus centre hole)	19mm	22mm



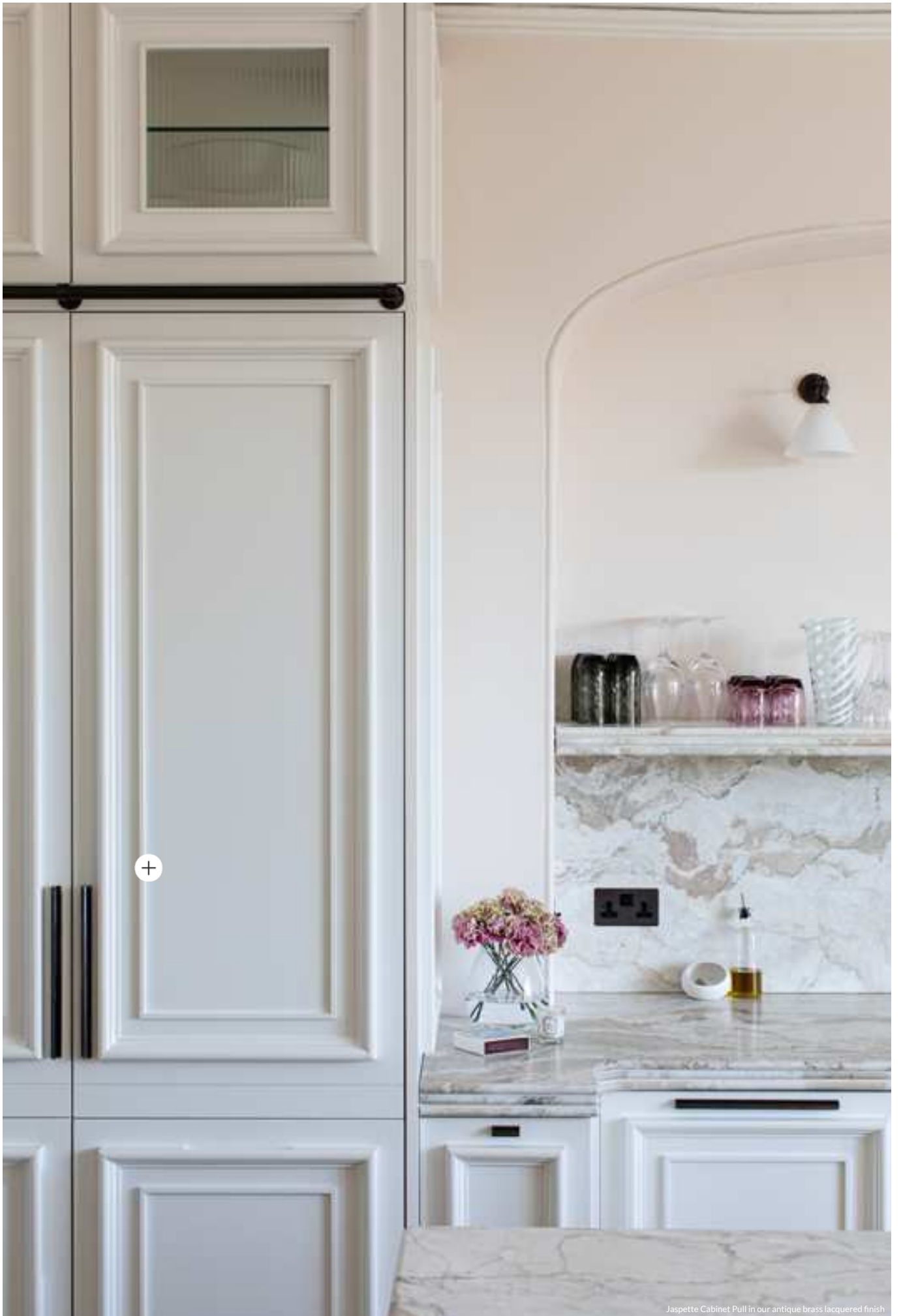

Jaspette Cabinet Pull in our antique brass lacquered finish

LONGBRIDGE COLLECTION

Clean lines lead the design of the Longbridge collection. Made from the finest solid brass, each contemporary extruded cabinet pull brings a modern look to interior cabinetry.



LONGBRIDGE CABINET PULL



Code	Length (L)	Centres (C)	Height (H)	Projection (P)
LON/32	32mm	N/A	28mm	26mm
LON/76	76mm	64mm	28mm	26mm
LON/180	180mm	160mm	28mm	26mm
LON/312	312mm	288mm	28mm	26mm

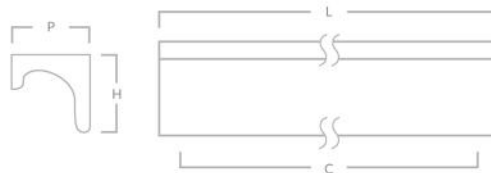



Longbridge Cabinet Pull in our burnished brass finish

CROXFORD COLLECTION

Featuring angled edges and clean lines, the Croxford collection is a perfect choice to accent modern spaces. Linear in design and extruded to create a functional cabinet pull.



CROXFORD CABINET PULL



Code	Length (L)	Centres (C)	Width (W)	Projection (P)
CRX/50	50mm	32mm	20mm	21mm
CRX/114	114mm	96mm	20mm	21mm
CRX/150	150mm	128mm	20mm	21mm
CRX/312	312mm	288mm	20mm	21mm
CRX/400	400mm	368mm (plus centre hole)	20mm	21mm
CRX/500	500mm	464mm (plus centre hole)	20mm	21mm

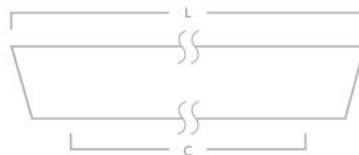

QUADRILLE COLLECTION

Expertly made from solid brass with a distinctive appearance, the Quadrille collection transforms contemporary cabinets and furniture.



QUADRILLE CABINET PULL



Code	Width (W)	Projection (P)	Height (H)
QUA/50	50mm	19mm	53mm
QUA/64	64mm	21mm	67mm
QUA/76	76mm	25mm	80mm

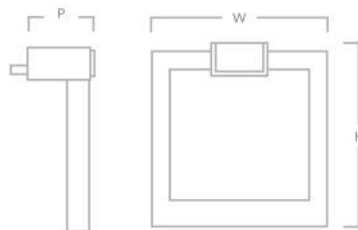

OBLIQUE COLLECTION

The juxtaposition of the inner circle to the outer circle has created a fantastic, almost optical, illusion of shape for this stylish and skilfully engineered set of furniture ring pull handles.

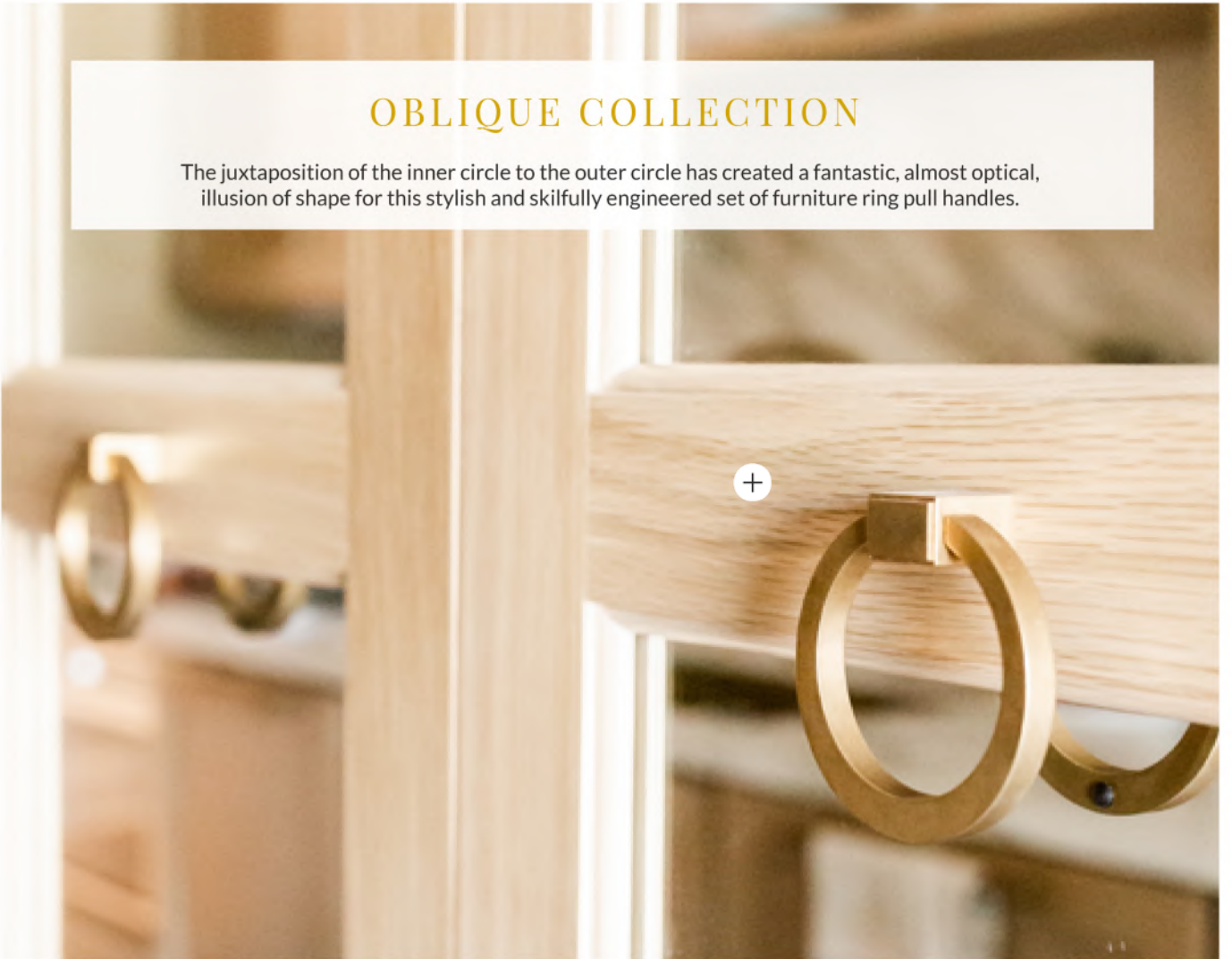

OBLIQUE CABINET PULL



Code	Diameter (D)	Projection (P)	Height (H)
OBL/50	50mm	19mm	51mm
OBL/64	64mm	21mm	65mm
OBL/82	82mm	25mm	86mm

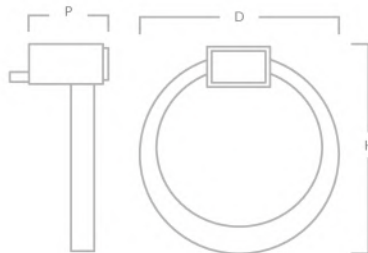



Oblique Cabinet Pull, Sparkbrook Cabinet Handle & MIX Diamond Knob in our burnished brass finish

FLUSH PULLS

Bring understated style and subtle interest to cabinetry with our collection of solid brass flush pulls. Rear fixed for a streamlined look, the pulls are an effortless choice to complement minimalistic decor.

LYNDON FLUSH PULL



Product photographed in our satin antique satin lacquered finish

Code	Width (W)	Projection (P)	Height (H)	Centres (C)	X	Y
LYN/FLUSH/100	100mm	18mm	57mm	88mm	81mm	32mm
LYN/FLUSH/175	175mm	18mm	57mm	163mm	156mm	32mm
LYN/FLUSH/250	250mm	18mm	57mm	238mm	231mm	32mm
LYN/FLUSH/350	350mm	18mm	57mm	338mm	331mm	32mm

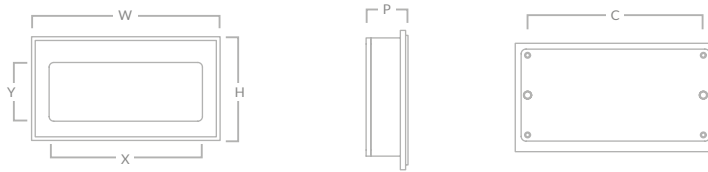

BARTLEY FLUSH PULL



Product photographed in our polished brass unlacquered finish

Code	Width (W)	Projection (P)	Height (H)	Centres (C)	X	Y
BAR/FLUSH/100	100mm	18mm	57mm	88mm	81mm	32mm
BAR/FLUSH/175	175mm	18mm	57mm	163mm	156mm	32mm
BAR/FLUSH/250	250mm	18mm	57mm	238mm	231mm	32mm
BAR/FLUSH/350	350mm	18mm	57mm	338mm	331mm	32mm

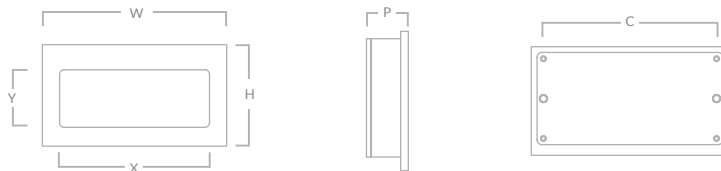

DRIFFOLD FLUSH PULL



Product photographed in our burnished brass finish

Code	Width (W)	Projection (P)	Height (H)	Centres (C)	X	Y
DRI/FLUSH/100	100mm	18mm	57mm	88mm	81mm	32mm
DRI/FLUSH/175	175mm	18mm	57mm	163mm	156mm	32mm
DRI/FLUSH/250	250mm	18mm	57mm	238mm	231mm	32mm
DRI/FLUSH/350	350mm	18mm	57mm	338mm	331mm	32mm

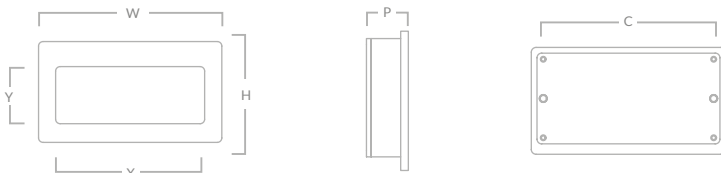

ADDITIONAL PRODUCTS

Alongside our core cabinetry hardware collections, we also produce complementary products to further add to the interior details of your space. From hooks and stays to card frames, hinges and magnetic catches, each is crafted from solid brass and available in many of our signature brass finishes.



Cotswold Cup Pull & Cotswold Ball Knob in our burnished brass finish

ADDITIONAL CABINET HANDLES

Supplied with screws.



Code	Width (W)	Height (H)	Projection	Centres
269/100	100mm	40mm	20mm	86mm

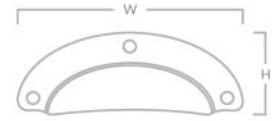

Code	Width (W)	Height (H)	Projection	Centres
888/102	98mm	27mm	18mm	86mm

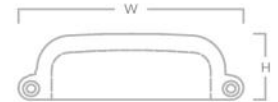

Code	Width (W)	Height (H)	Projection
2174/95	95mm	41mm	23mm

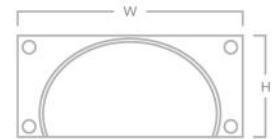

Code	Centres (C)	Width (W)	Height	Projection (P)
4030/102	76mm	98mm	19mm	27mm

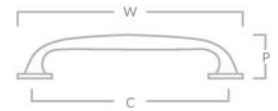

Code	Width (W)	Height	Projection (P)	Centres (C)
4034/127	125mm	27mm	26mm	96mm

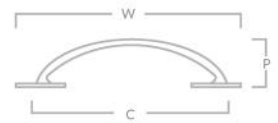

Code	Width (W)	Projection (P)	Centres (C)
4037/114	120mm	26mm	107mm

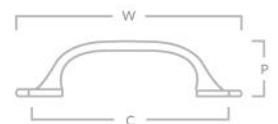

Code	Width (W)	Projection (P)
4040/152	165mm	39mm



ADDITIONAL CABINET KNOBS

Supplied with screws.



Code	Projection (P)	Base Dia. (BD)
2325/19	20mm	19mm
2325/25	26mm	25mm
2325/32	32mm	28mm
2325/38	38mm	30mm

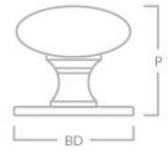

Code	Projection (P)	Diameter (D)	Base (B)
3169/32	30mm	32mm	38mm
3169/38	37mm	38mm	38mm



Code	Projection (P)	Diameter (D)	Base (B)
4055/16	21mm	16mm	12.5mm
4055/19	26mm	19mm	16mm
4055/25	33mm	25mm	20mm
4055/32	39mm	32mm	22mm



Code	Projection (P)	Diameter (D)	Base (B)
4056/25	18mm	25mm	13mm
4056/38	22mm	38mm	17mm
4056/45	26mm	45mm	20mm

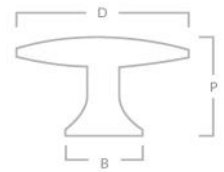

Code	Projection (P)	Diameter (D)	Base (B)
4056H/25	18mm	25mm	13mm
4056H/38	22mm	38mm	17mm
4056H/45	26mm	45mm	20mm

Note - hand hammered

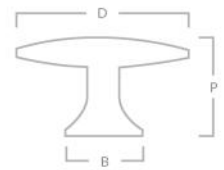

Code	Projection (P)	Diameter (D)	Base (B)
4059/34	36mm	34mm	32mm



Code	Diameter (D)	Projection (P)	Base (B)
ASTK/25	25mm	25mm	23mm
ASTK/32	32mm	32mm	29mm



HOOKS

Supplied with screws.



Code	Projection (P)	Height (H)	Width
0783/38	38mm	47mm	19mm
0783/50	52mm	54mm	24mm
0783/64	54mm	58mm	28mm

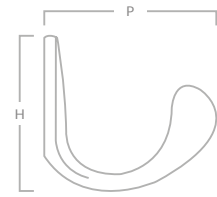

Code	Projection (P)	Height (H)	Fits Tube Dia.
0789/19	49mm	55mm	19mm
0789/25	54mm	63mm	25mm

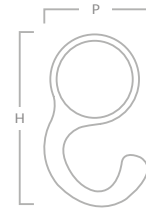

Code	Projection (P)	Height (H)	Width
0810/127	55mm	118mm	35mm
0810/152	75mm	135mm	35mm

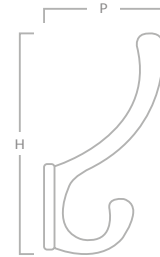

Code	Projection (P)	Height (H)	Width
0820/114	87mm	87mm	31mm

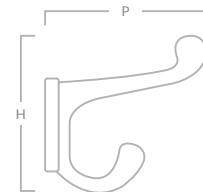

Code	Projection (P)	Height (H)	Width
0845/64	24mm	45mm	67mm
0845/70	26mm	49mm	70mm



Code	Projection (P)	Height (H)
2109/38	45mm	40mm

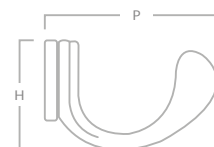

CARDFRAMES

Supplied with screws.



Code	Width (W)	Height (H)	Window
0788/50	50mm	25mm	36mm x 16mm
0788/64	63.5mm	38mm	46mm x 23mm
0788/76	76mm	50mm	55mm x 36mm

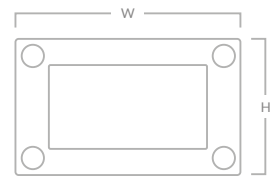

Code	Width (W)	Height (H)	Projection	Window
1845/64	61mm	38mm	19mm	44mm x 14mm

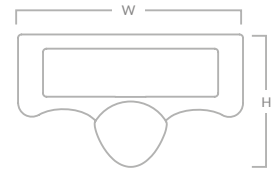

Code	Width (W)	Height (H)	Projection	Window
2091/64	62mm	57mm	20mm	42mm x 21mm

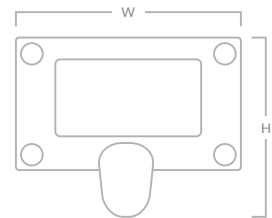

Code	Width (W)	Height (H)	Window
2054/120	120mm	51mm	88mm x 36mm



Code	Width (W)	Height (H)	Projection	Window
2541/95	96mm	74mm	25mm	72mm x 24mm

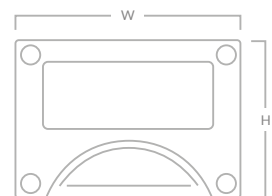

HINGES

Screws sold separately.

Sold in pairs.



Code	Height (H)	Width (W)	Hinge Screws
204/38	38mm	23mm	4g
204/50	50mm	28mm	6g
204/64	64mm	35mm	6g
204/76	76mm	42mm	8g

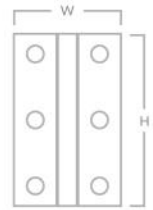

Code	Height (H)	Width (W)	Hinge Screws
207/50	50mm	38mm	6g
207/64	64mm	38mm	8g
207/76	76mm	50mm	8g

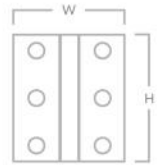

Code	Height (H)	Width (W)	Hinge Screws
207/50/1SLOT	50mm	38mm	6g
204/76/1SLOT	76mm	42mm	8g

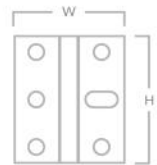

Code	Height (H)	Width (W)	Hinge Screws
207/50/2SLOT	50mm	38mm	6g
204/64/2SLOT	76mm	42mm	6g

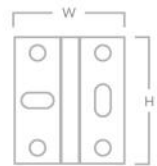

Code	Height (H)	Width (W)	Hinge Screws
2300/50	50mm	38mm	6g
2300/64	64mm	50mm	6g
2300/76	76mm	50mm	6g

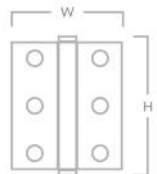

Code	Height (H)	Width (W)	Hinge Screws
205/65	63.5mm	14mm	4g
205/75	75mm	24mm	4g

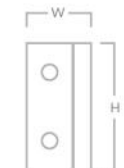

FINIALS & SCREWS

Finials sold in sets of 4.

To be ordered for use with our hinges.



Code	Projection	Diameter
2301/BALL (SET OF 4)	10mm	6mm

2301/BALL and 2301/URN finials are for use with 2300 hinges only



Code	Projection	Diameter
2301/STEEPLE (SET OF 4)	22mm	6mm

2301/BALL and 2301/URN finials are for use with 2300 hinges only

POZI SCREWS



Code	Width	Height
SBF12/P/4X3/4	4G	19mm
SBF12/P/6X3/4	6G	19mm
SBF12/P/8X3/4	8G	19mm

Screws sold in sets of 12

SLOTTED SCREWS



Code	Width	Height
SBF12/S/4X3/4	4G	19mm
SBF12/S/6X3/4	6G	19mm
SBF12/S/8X3/4	8G	19mm

Screws sold in sets of 12

MAGNETIC CATCHES

Supplied with screws.

LEL01 SILENT MAGNETIC CATCH (5KG MAGNET PULL STRENGTH)



Bronze



Black Nickel



Chrome



Gilt

LM5402 FACE FIX MAGNETIC CATCH (4KG MAGNET PULL STRENGTH)



Bronze



Nickel



Chrome



Gilt

LM5103 FACE FIX MAGNETIC CATCH (4KG MAGNET PULL STRENGTH)



Bronze



Bright Nickel



Chrome



Gilt



Nickel

DECORATIVE GRILLES

Handcrafted in the heart of England, our decorative grilles bring an ornate elegance to cabinets, panels, doors, vents or radiator covers. Assembled by hand and precisely trimmed to fit your required aperture, our solid brass grilles are designed to showcase a perfectly symmetrical pattern. No matter your decor, discover the perfect style to complement your design concept.





Regency Diamond Grille in our satin brass finish with coarse mesh backing and Bromford Handle in our burnished brass finish

GRILLE FINISHES

Our expertly crafted luxury brass grilles come in ten beautiful finishes.

These can be applied to all brass grilles, however are not suited to stainless steel or aluminium.

Please note, antique brass and bronze metal antique finishes can vary slightly from order to order as these are hand-finished. Antique brass, antique copper, bronze metal antique and antique silver are lacquered and it is not an option to have it removed.



Antique brass lacquered



Antique copper lacquered

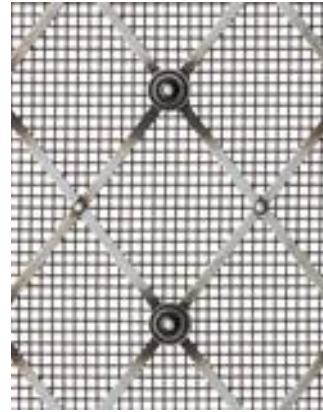

Antique silver lacquered

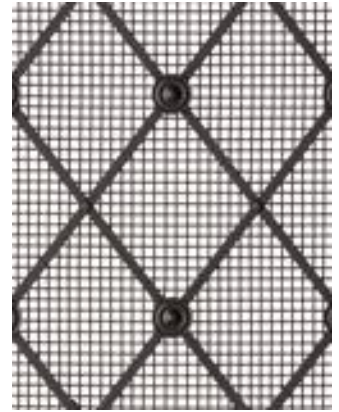

Bronzed metal antique
lacquered



Polished chrome plate



Polished nickel plate



Satin brass lacquered



Satin brass unlacquered



Satin chrome plate



Satin nickel plate

Maximum sizes for finishes, excluding brass and antique which can be larger, is 1829mm x 762mm



MIX Diamond Appliance Handle, Regency Diamond Grille and Edgbaston Pull in our satin brass unlacquered finish

REGENCY DIAMOND GRILLES

Handcrafted in solid brass, our Regency Diamond Grilles add an elegant touch to interiors. Featuring a perfectly symmetrical pattern assembled by hand and trimmed to fit your required aperture, your grille will come ready to fit.

DIAMOND OPTIONS

Available in three different diamond sizes, each made from a 3.2mm square section brass bar and fitted to hold with decorative pins.

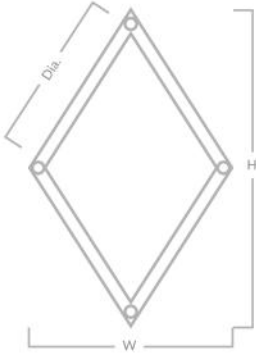

Code	Width (W)	Height (H)	Internal Diagonal Dia. (Dia.)
G200	33mm 1-5/16"	44mm 1-11/16"	25mm 1"
G201	51mm 2"	64mm 2-1/2"	38mm 1-1/2"
G202	70mm 2-3/4"	89mm 3-1/2"	54mm 2-1/8"

ROSETTE OPTIONS AND FORMATION

Available with the option of plain or floral rosettes on every crossover or alternating crossovers. They can also be supplied without rosettes, showing the pinheads only. An additional option of a mixed finish is available on request for some grilles.

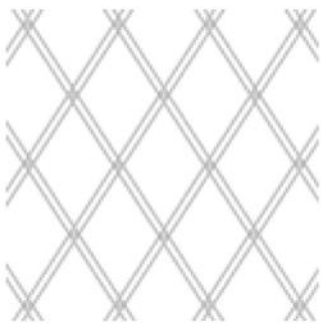

No rosette

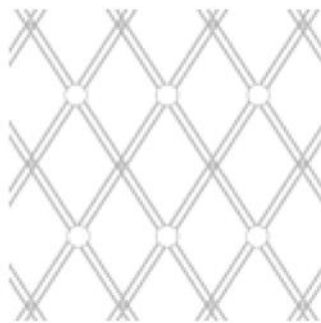

Alternate rosette

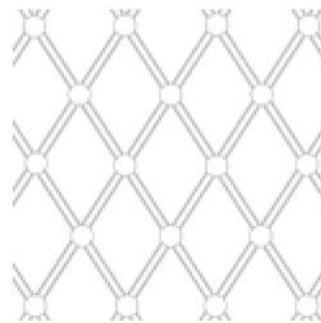

All rosette



Plain



Floral

MESH OPTIONS

Available with a number of mesh options, for more information, please see page 123.

METAL FRAME

Available with a metal frame, for more information please see page 122.

FINISH OPTIONS

To see our ten grille finishes in full, please turn to page 102.



Please turn to page 124 for details on how to order your grille



Lincoln Cabinet Knob in our satin antique satin lacquered finish & Regency Diamond Grille in our antique brass lacquered finish

MIXED FINISH

- Grilles without rosettes can only be satin brass and satin brass lacquered but with a backing mesh in any other finish
- Grilles with alternate rosettes can be mixed with two finishes (excluding BMA). The grille is one finish and the mesh and rosettes a different finish
- Grilles with Rosettes on all joins cannot be offered in a mixed finish

CUT PINS

(The pins used to assemble the grilles are clipped at the back and hammered over to create a cleaner look)

- They are only offered when grilles have no mesh backing
- They cannot be offered on grilles with polished nickel, polished chrome or BMA

Please turn to page 124 for details on how to order your grille

ELLIPTICAL GRILLES

Our Elliptical Pattern Grilles add a truly sophisticated look to cabinet doors, radiator covers and more. Handcrafted from solid brass and made to fit into your required aperture, they come ready to fit.

ORIENTATION OPTIONS

The ellipses will stretch to match either the height or width of your required measurements as indicated by the orientation below.

Please note, the longer measurement of your required panel needs to run in alignment with the stacked ellipses to achieve the desired look. For example, the height of the vertical grilles should be longer than the width

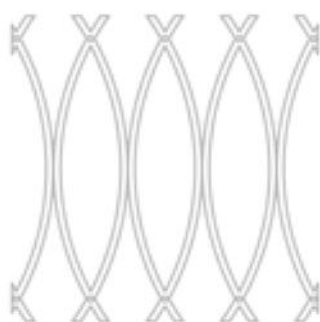

Horizontal

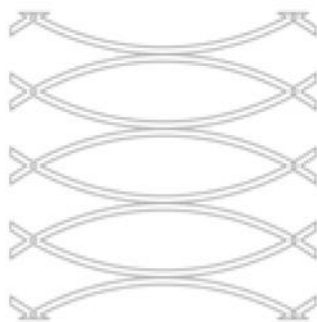

Vertical



ROSETTE OPTIONS AND FORMATION

Available with the option of plain or floral rosettes on every crossover. They can also be supplied without rosettes, showing the pinheads only.

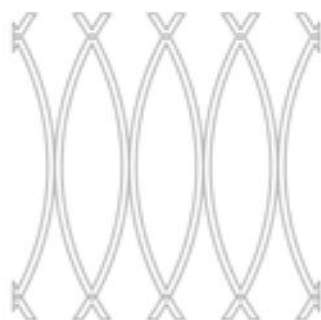

No rosette

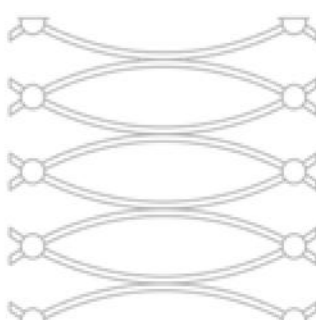

All rosette



Plain



Floral

MESH OPTIONS

Available with a number of mesh options, for more information, please see page 123.

METAL FRAME

Available with a metal frame, for more information please see page 122.

FINISH OPTIONS

To see our ten grille finishes in full, please turn to page 102.



Please turn to page 124 for details on how to order your grille



Elliptical Grille in our antique silver finish

GEORGIAN SQUARE GRILLES

Our Georgian Square Grilles add a touch of finesse to panels, doors, vents and more. Handcrafted from solid brass and made to fit into your required aperture, they come ready to install.

SQUARE OPTIONS

Available in three different square sizes, each made from a 3.2mm square section brass bar and fitted to hold with decorative pins.

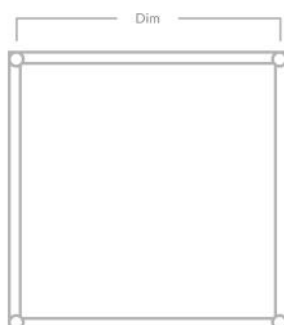

Code	Dimensions (Dim)
G300	25mm 1"
G301	38mm 1 1/2"
G302	54mm 2 1/8"

ROSETTE OPTIONS AND FORMATION

Available with the option of plain or floral rosettes on every crossover. They can also be supplied without rosettes, showing the pinheads only.

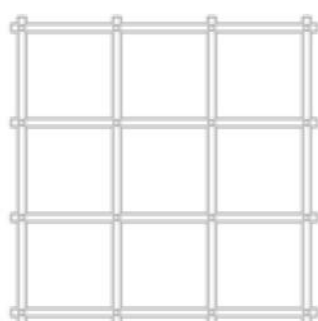

No rosette

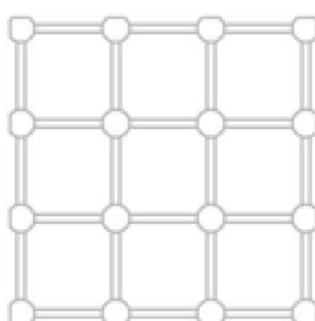

All rosette



Plain



Floral

MESH OPTIONS

Available with a number of mesh options, for more information, please see page 123.

METAL FRAME

Available with a metal frame, for more information please see page 122.

FINISH OPTIONS

To see our ten grille finishes in full, please turn to page 102.



Please turn to page 124 for details on how to order your grille

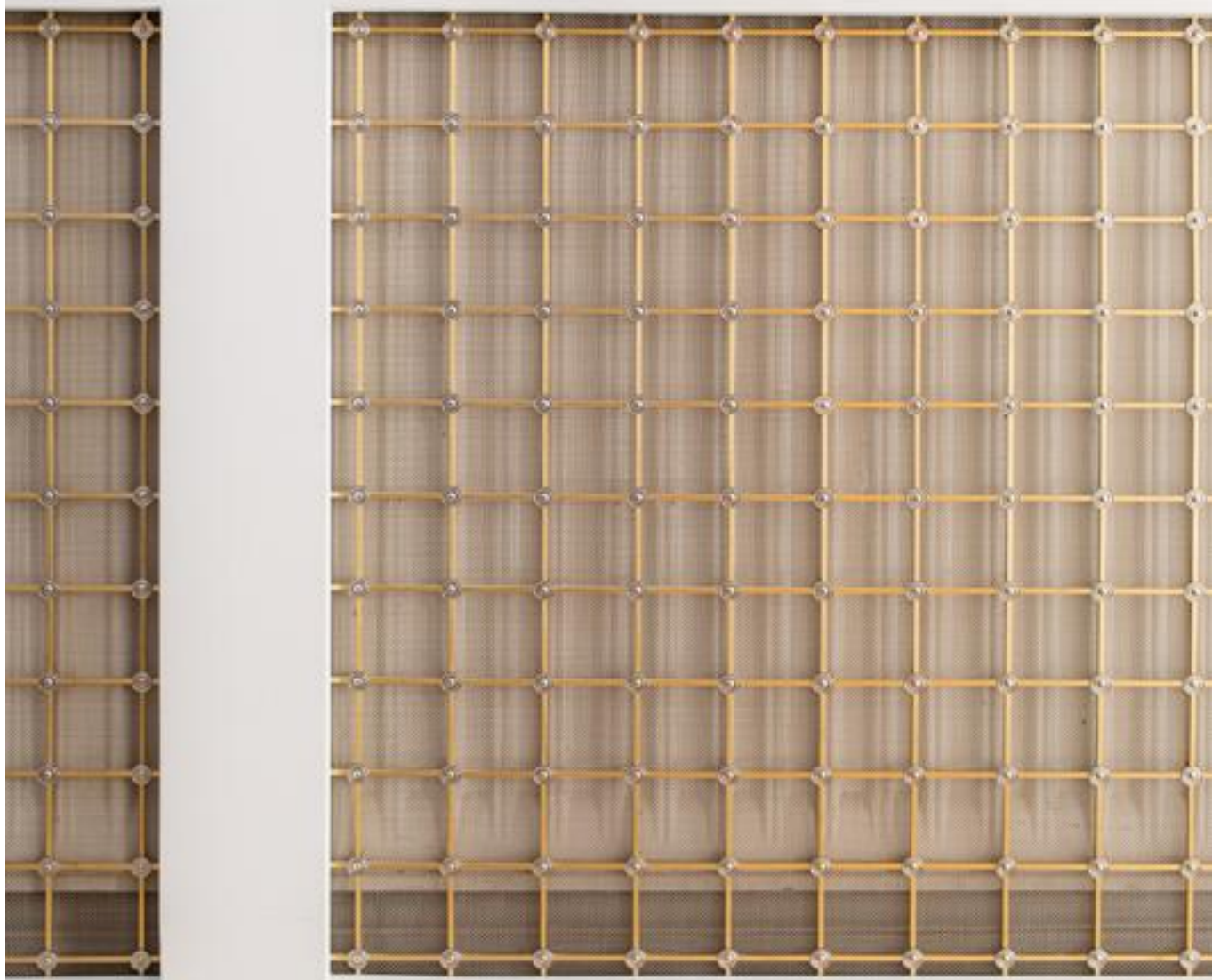

Georgian Square Grille in our satin brass finish with polished nickel plain rosettes

DIAMOND INTERWOVEN GRILLES

A basket weave style, our hand-woven Diamond Interwoven Grille is available in a number of different apertures and section size configurations and is supplied in a diamond layout with either plain or reeded style sections.

DIAMOND OPTIONS

Available in four different diamond sizes.

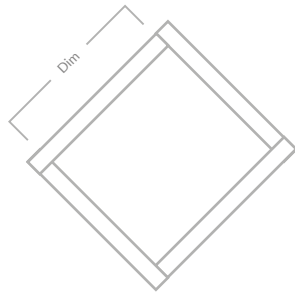

Dimensions (Dim)
10mm 3/8"
13mm 1/2"
19mm 3/4"
25mm 1"

PLAIN OR REEDED WIRE

Interwoven grilles are available in both plain and reeded wires with an option of 3mm & 5mm wire width. 3mm wire is not available with 25mm diamond sizes



Plain wire



Reeded wire

MESH OPTIONS

Available with a number of mesh options, for more information, please see page 123.

METAL FRAME

Available with a metal frame, for more information please see page 122.

FINISH OPTIONS

To see our ten grille finishes in full, please turn to page 102.



Please turn to page 124 for details on how to order your grille



Diamond Interwoven Grille in our antique brass lacquered finish

SQUARE INTERWOVEN GRILLES

A basket weave style, our hand-woven Square Interwoven Grille is available in a number of different apertures and section size configurations and is supplied in a square layout with either plain or reeded style sections.

SQUARE OPTIONS

Available in four different square sizes.

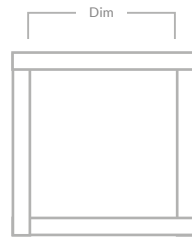

Dimensions (Dim)
10mm 3/8"
13mm 1/2"
19mm 3/4"
25mm 1"

PLAIN OR REEDED WIRE

Interwoven grilles are available in both plain and reeded wires with an option of 3mm & 5mm wire width. 3mm wire is not available with 25mm square sizes.



Plain wire



Reeded wire

MESH OPTIONS

Available with a number of mesh options, for more information, please see page 123.

METAL FRAME

Available with a metal frame, for more information please see page 122.

FINISH OPTIONS

To see our ten grille finishes in full, please turn to page 102.



Please turn to page 124 for details on how to order your grille



Square Interwoven Grille in our polished nickel finish and Cotswold Cupboard Latch & Queslett Pull in our polished nickel finish

DOUBLE SQUARE INTERWOVEN GRILLES

A basket weave style, our hand-woven Double Square Interwoven Grille is available in a number of different apertures and section size configurations and is supplied in a square layout with either plain or reeded style sections.

SQUARE OPTIONS

Available in three different square sizes.

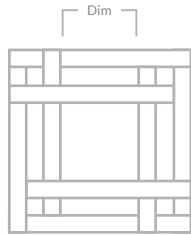

Code	Dimensions (Dim)
G656	13mm 1/2"
G656	19mm 3/4"
G656	25mm 1"

PLAIN OR REEDED WIRE

Double interwoven grilles are available in both plain and reeded wires with a 3mm wire width.



Plain wire



Reeded wire

MESH OPTIONS

Available with a number of mesh options, for more information, please see page 123.

METAL FRAME

Available with a metal frame, for more information please see page 122.

FINISH OPTIONS

To see our ten grille finishes in full, please turn to page 102.



Please turn to page 124 for details on how to order your grille

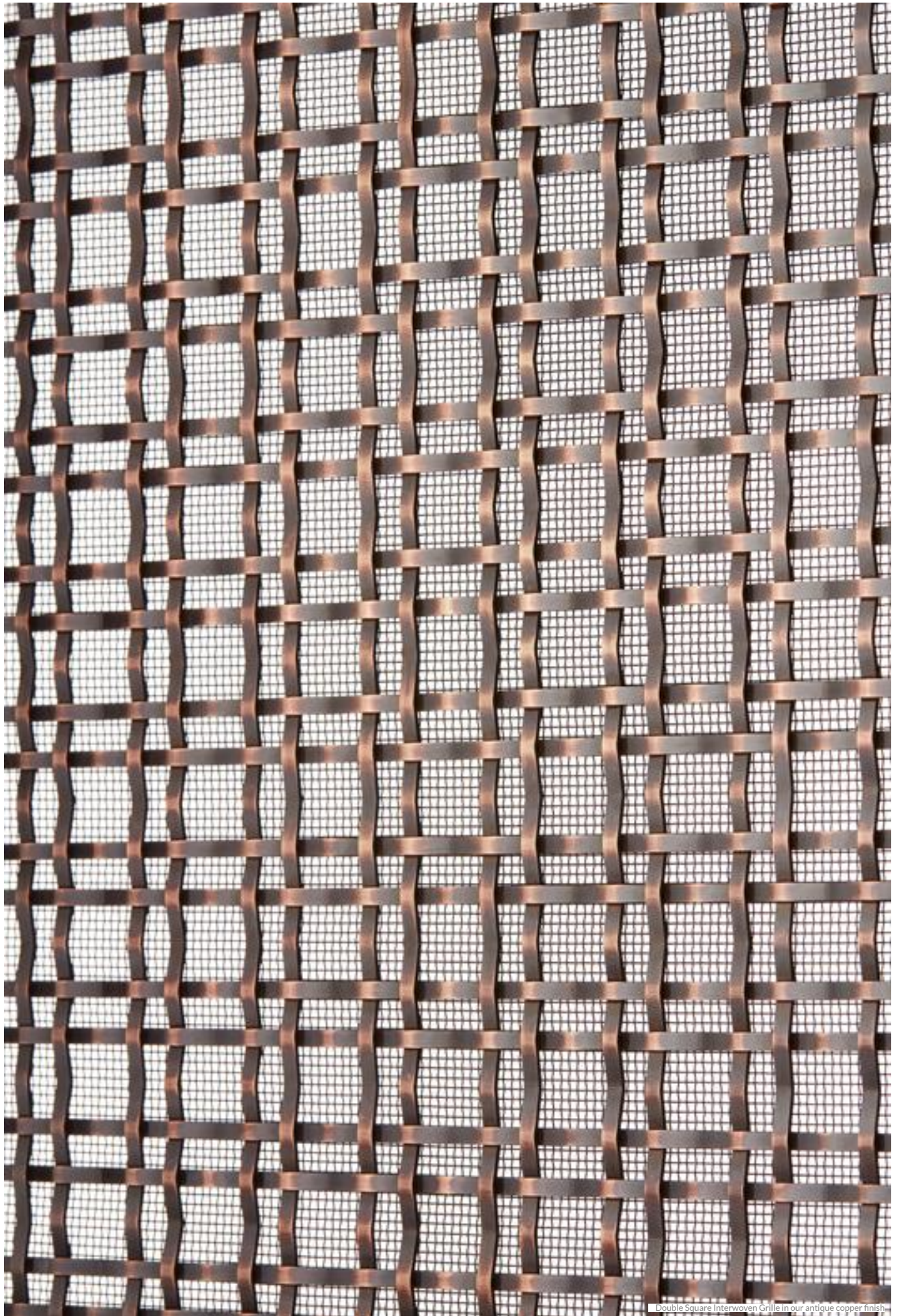

Double Square Interwoven Grille in our antique copper finish

DOUBLE DIAMOND INTERWOVEN GRILLES

A basket weave style, our hand-woven Double Diamond Interwoven Grille is available in a number of different apertures and section size configurations and is supplied in a diamond layout with either plain or reeded style sections.

DIAMOND OPTIONS

Available in three different diamond sizes.

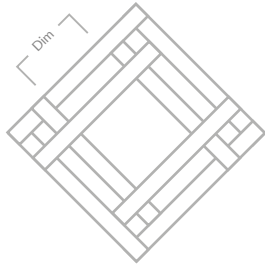

Code	Dimensions (Dim)
G656	13mm 1/2"
G656	19mm 3/4"
G656	25mm 1"

PLAIN OR REEDED WIRE

Double interwoven grilles are available in both plain and reeded wires with a 3mm wire width.



Plain wire



Reeded wire

MESH OPTIONS

Available with a number of mesh options, for more information, please see page 123.

METAL FRAME

Available with a metal frame, for more information please see page 122.

FINISH OPTIONS

To see our ten grille finishes in full, please turn to page 102.



Please turn to page 124 for details on how to order your grille



Double Diamond Interwoven Grille in our antique brass lacquered finish and our Bournville Cabinet Handle in our burnished brass finish

DOUBLE RECTANGULAR INTERWOVEN GRILLES

A basket weave style, our hand-woven Double Rectangular Interwoven Grille is available in two orientations and is supplied in a rectangular layout with either reeded or plain style sections.

ORIENTATION OPTIONS

Available in horizontal or vertical style.

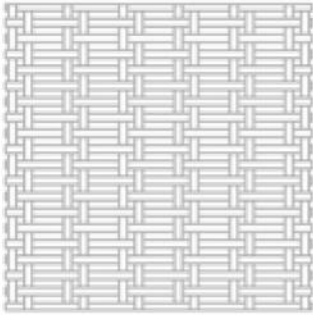

Horizontal

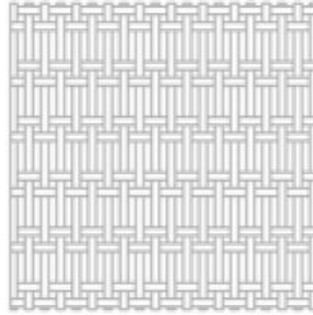

Vertical

Code	Dimensions
G657	13mm x 3mm 1/2" x 3/16"

PLAIN OR REEDED WIRE

Double interwoven grilles are available in both plain and reeded wires with a 3mm wire width.



Plain wire



Reeded wire

MESH OPTIONS

Available with a number of mesh options, for more information, please see page 123.

METAL FRAME

Available with a metal frame, for more information please see page 122.

FINISH OPTIONS

To see our ten grille finishes in full, please turn to page 102.



Please turn to page 124 for details on how to order your grille

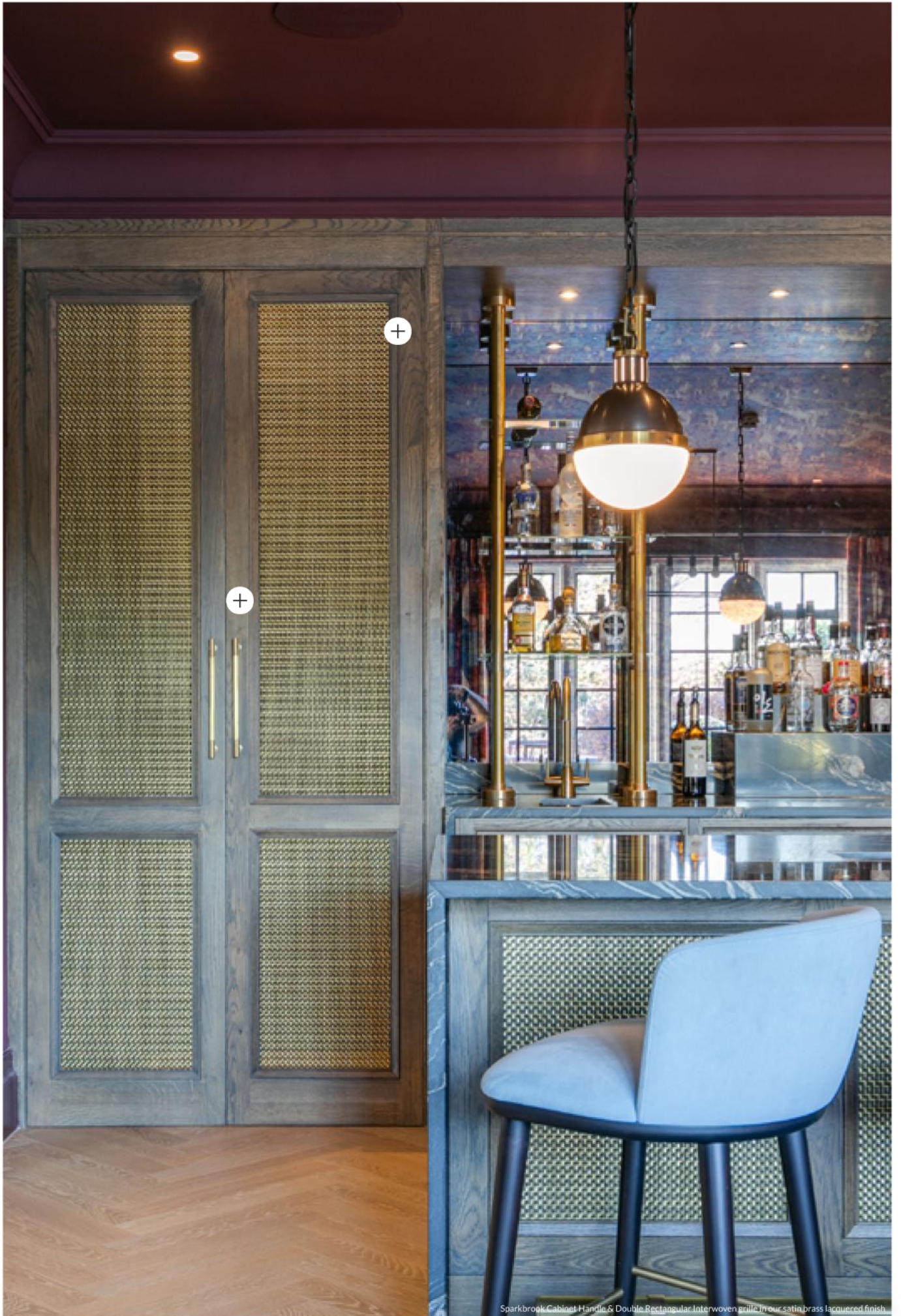

PERFORATED SHEET GRILLES

Our decorative perforated sheet grilles are used in kitchens as radiator covers or on interior doors.



G204 Large Cross
23mm point to point



G206 Interlocking Circle
34.9mm circle diameter

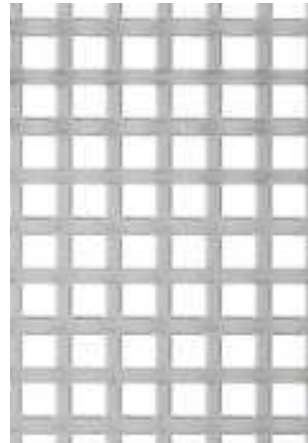

G811 Square Brass
6.3mm internal square



G205 - Small Club
6mm max width



G208 Small Cross
15mm point to point



G223 Large Club
19mm max width

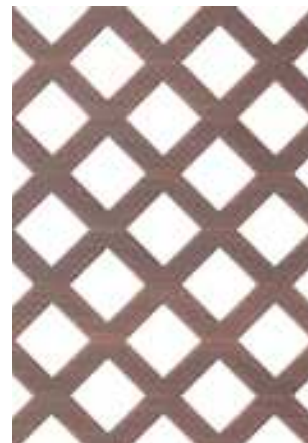

G810 Diamond
9.5mm internal square



G207 Hexagonal
internal lozenge
19mm high x 9.5mm wide

SPECIFICATIONS

- Available in standard full sheets, 2m x 1m
- Each perforated sheet measures at 2000mm x 1000mm as the sheets have a small border, the patterned area of the sheet measures at 1970mm x 970mm
- Sheet thickness is 0.8mm
- Also available in Aluminium, self-colour only

METAL FRAME

Available with a metal frame, for more information please see page 122.

FINISH OPTIONS

To see our ten grille finishes in full, please turn to page 102.



Please turn to page 124 for details on how to order your grille



Hexagonal Grille in our polished brass lacquered finish and Bakes Cabinet Handle in our satin antique satin lacquered finish



METAL FRAMES

All of the grilles featured in our catalogue can be supplied with an added metal frame.
We offer four frame options; Angle, Channel, Flat and T section.

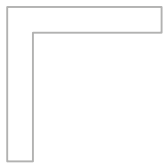

Angle Section

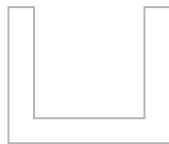

Channel Section



Flat Section



T Section

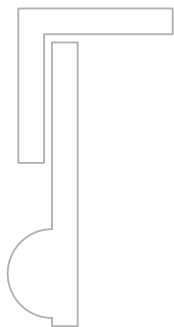

Angle Section
attached to grille (side view)

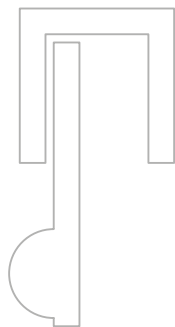

Channel Section
attached to grille (side view)

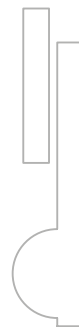

Flat Section
attached to grille (side view)

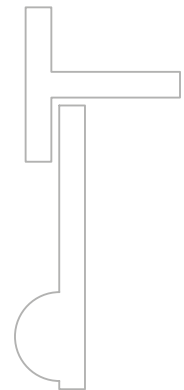

T Section
attached to grille (side view)

ADDITIONAL INFORMATION

- All can be supplied in either a 12.7mm, 19.1mm or 25.4mm face width
- Frames are made from solid brass 3.2mm thick section and can be finished to match the grille required
- Screw holes can be added to the face of the frame for fixing if required

MESH

Our mesh is used with many of our other grilles as a backing but it can also be applied alone when something simple is required.

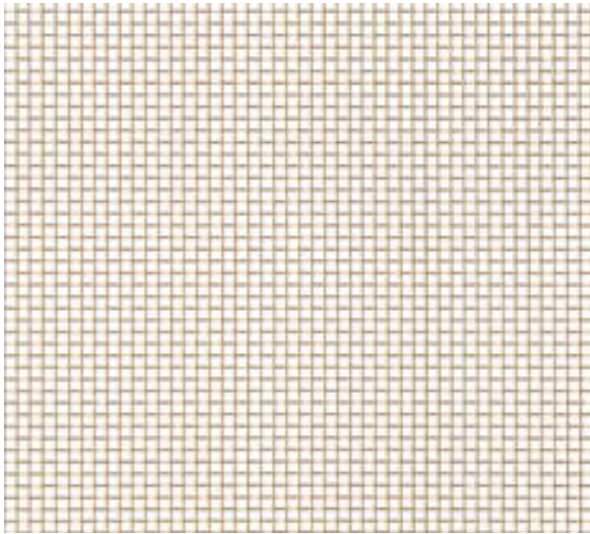

G213 - Fine Mesh Brass
Square Holes 1mm Internal
Mesh is 0.65mm thick

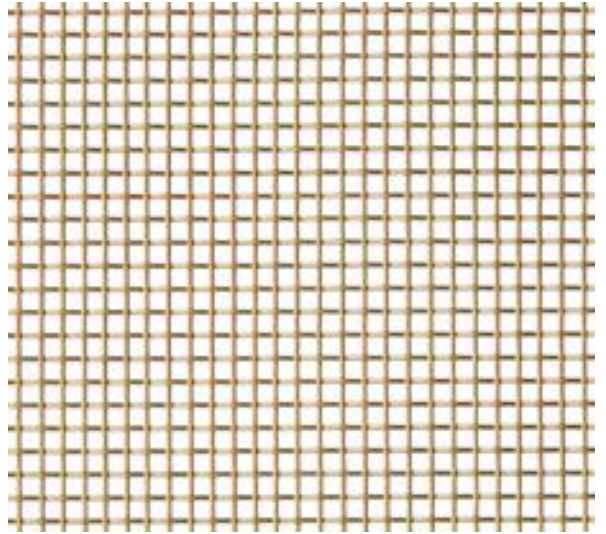

G214 - Coarse Mesh Brass
Square Holes 3mm Internal
Mesh is 1.3mm thick

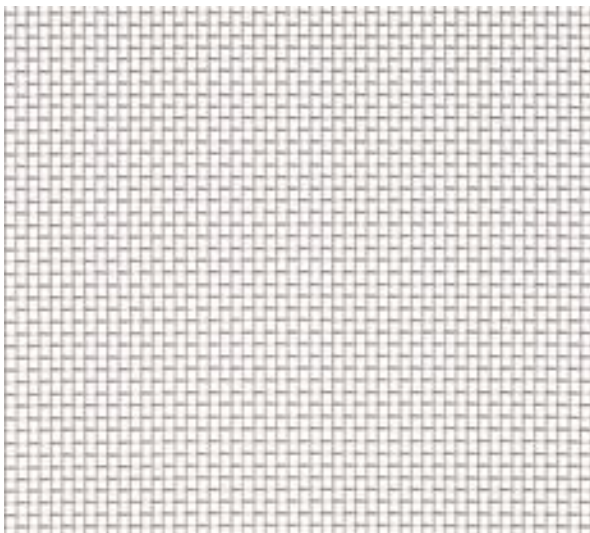

G213 - Fine Mesh Stainless Steel
Square Holes 1mm Internal
Mesh is 0.65mm thick

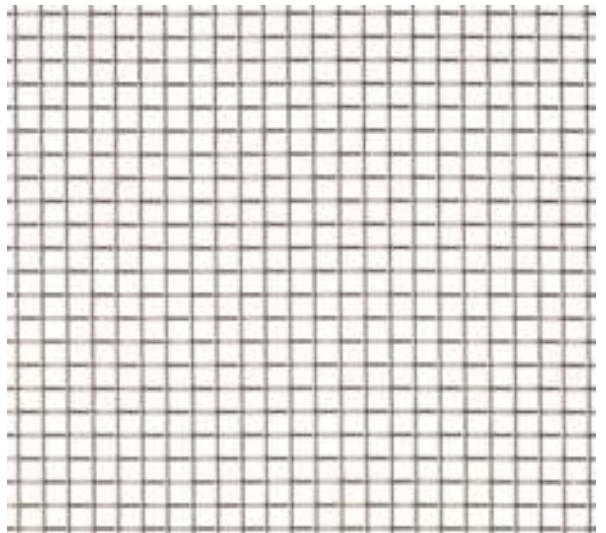

G214 - Coarse Mesh Stainless Steel
Square Holes 3mm Internal
Mesh is 1.3mm thick

ADDITIONAL INFORMATION

- Both available cut to size and also on a roll 1200mm high (approx. 4ft)
- Both available in Brass and Stainless Steel
- Finishes available on Brass material only

FINISH OPTIONS

To see our ten grille finishes in full, please turn to page 102.



HOW TO ORDER YOUR GRILLE

To place an order for a decorative grille, please email sales@armacmatin.co.uk with your enquiry.

Use the guide below to help provide as much information as possible.

REQUIRED FOR ALL GRILLES

- Supply and identify the height and width of your panel. This should be the actual size you require, including the rebate of your door. Please allow 1.6mm all around to allow the grille to fit in your rebate comfortably
- Note the finish required
- Note if you require a metal frame

ADDITIONAL DETAILS

Regency Diamond and Georgian Square

- Advise if backing mesh is required and specify G213 or G214 (see page 123)
- Advise if rosettes are required and if on every intersection or on alternate intersections
- Advise if you require roses, pinheads or both and the type of rosette required

Elliptical grilles

- Note which way you require the ellipses to run - horizontally or vertically (as pictured on page 106)
- Advise if backing mesh is required and specify G213 or G214 (see page 123)
- Advise if rosettes are required and if so which style

Interwoven grilles

- Note if you require a diamond, square or rectangular pattern
- Note the aperture size required
- Note if you'd like plain or reeded section and the size required
- Advise if backing mesh is required and specify G213 or G214 (see page 123)

Frames

- Note the type and size of frame required
- Supply the aperture (hole size) or overall size (including frame)
- Advise if screw holes are required in the frame for fixing

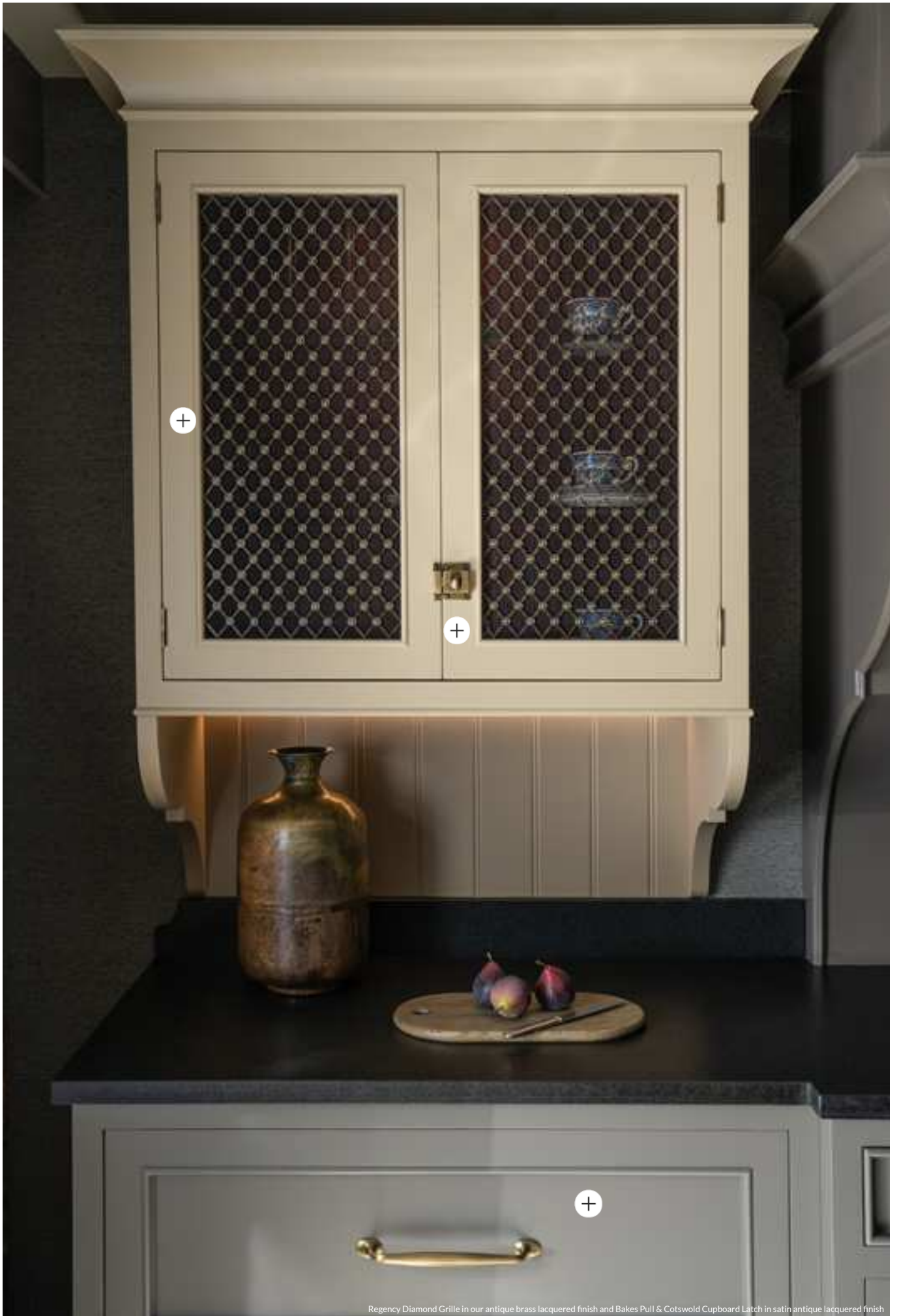

Regency Diamond Grille in our antique brass lacquered finish and Bakes Pull & Cotswold Cupboard Latch in satin antique lacquered finish

ACKNOWLEDGEMENTS

Armac Martin would like to thank the following for their support in arranging locational photography.

Higham Furniture	7	Eadon Stone Bespoke Design Photography by Laura Marin Photo	66
Cella Jane	14	J Kath Design and Build Photography by Spacecrafting	67
Sophie Paterson Interiors Photography by Raymain	21	Provincial Kitchens AU	68
Sophie Paterson Interiors Photography by Raymain	26	Steve Cordony	69
Aysha Nassar Interiors	28	Kitchen by Peden & Pringle Photography by Paul Craig	70
McClark Bespoke Interiors Photograh by Snook	30	Kitchen by Blakes London Photography by 82mm	71
McClark Bespoke Interiors Photograh by 82mm	32	Laura Hammett Photography by Julian Abrams	72 - 73
Jean Stoffer Design Photography by Stoffer Interiors	33	Monika Hibbs	74
Jean Stoffer Design Photography by Stoffer Interiors	34	Crouch Design	75
Maison Birmingham	35	Richard Burke Design	76
Rachael Somerville Photography by Handover	36	Atelier Cabinet Makers	77
Woodale Designs	37	McClark Bespoke Interiors Photograh by Snook	78-79
Jean Stoffer Design Photography by Stoffer Interiors	38	The Pink House Project	
Richard Burke Design	39	Woodale Design	80
Sophie Paterson Interiors Photography by Raymain	40-41	Kitchen by Blakes London Photography by 82mm	81
Richard Burke Design	42	Studio Eliste	82
Eilish Rickard Interiors Newcastle Design	43	Sola Kitchens	83
Maison Birmingham	44	Kitchen by Blakes London Photography by 82mm	84
Woodale Designs	45	Laura Butler Madden Photography by Butler Madden	85
Wendy Word Design	46	Louise Bramhill Interiors	86
Christopher Peters Kitchens	47	Jean Stoffer Design Photography by Stoffer Interiors	87
Sophie Paterson Interiors Photography by Raymain	48 - 50	Sola Kitchens	88
Finch Interior Design Photograh by Snook	51	Bespoke of Winchester	89
Stephenson Wright Styling by Florence Rolfe	52	Cella Jane	90 - 91
Photography by Alexander James		Rachael Somerville Photography by Handover	93
Laura Hollingsworth Design Simon Whitbread Photography	53	Maison Birmingham	100-101
Noel Dempsey Design	54	Cella Jane	103
Kitchen by Bondi Kitchens Photography Jacqui Turk	55	Sola Kitchens	105
Sophie Paterson Interiors Photography by Raymain	56	Laura Butler Madden Photography by Butler Madden	109
Sita Montgomery Interiors	57	Barr Joinery	111
Sophie Paterson Interiors Photography by Raymain	58	Bakes and Kropp Becky M Shea	113
Laura Butler Madden Photography by Butler Madden	59	Amber Yard Interiors Photography by Darren Chung	117
Studio McGee	60	St Giles Furniture Photography by Chris Wharton	119
Monika Hibbs	61	Kitchen by Peden & Pringle Photography by Paul Craig	121
Kate Marker Interiors	62-63	Canavan Interiors Photography by Peter Bruce	125
McClark Bespoke Interiors Photograh by Snook	64		

CONTACT US

For further assistance, please contact us using the details below. Alternatively, please visit our website: www.armacmartin.co.uk

email: sales@armacmartin.co.uk

tel: +44 (0)121 359 2111

opening hours: Mon to Thurs - 9am to 5pm | Friday - 9am to 1pm

Armac Manufacturing (Brassfounders) Limited is a company registered in England and Wales with company number - 01348284

For the defining details

Armac Manufacturing (Brassfounders) Ltd
160 Dollman Street
Birmingham
B7 4RS
England

sales@armacmartin.co.uk | +44 (0)121 359 2111 | armacmartin.co.uk